

WPFX SERIES Outdoor Lighting

WPFX-MD-20-40W-MCTP-P

MCTP Multi Color Temperature & Multi Power/Wattage (Selectable)

Customer Name: _____

Project Name: _____

Note: _____

Type: _____

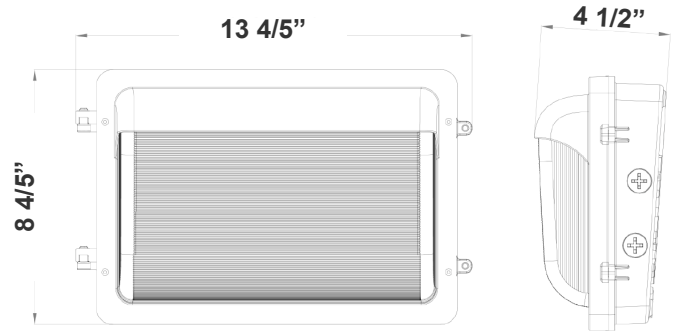
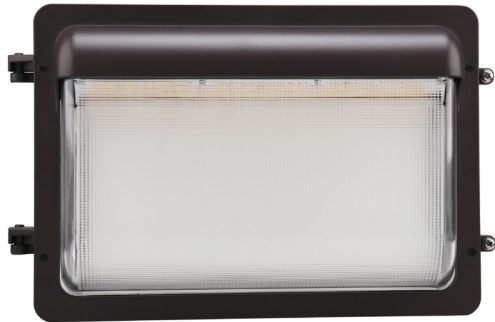

Ideal for general site lighting, alleys, loading docks, doorway, pathway, and parking areas. Great for use with motion sensors or another instant on/off controls.

13 4/5" (W) x 8 4/5" (H) x 4 1/2" (D)

Features

- High Light Transmittance, Anti-UV and Fire Resistant PC Lens
- Two 1/2" Knockouts on Each Side
- 7-Year Warranty
- Die-Cast Aluminum With Powder Coat Finish (Dark Bronze)
- Multi Color Temperature & Multi Power/Wattage (Selectable)

Technical Specifications

Electrical:

- Voltage: 120-277V AC 60Hz
- Wattage: 20W/30W/40W
- Power Factor: >0.9
- THD: <20%
- Efficacy: 130 LPW

Mechanical:

- Die-Cast Aluminum With Powder Coat Finish
- High Light Transmittance, Anti-UV and Fire Resistant Shatterproof PC Lens
- DC Button Photocell with ON/OFF switch Included
- Two 1/2" Knockouts on Each Side
- Operating Temperature: -40°F -113°F
- 7-Year Warranty
- IP65, Suitable For Wet Location

Lighting:

- Dimming: 0~10V Dimmable
- Multi CCT(Switches are inside fixture)
- Lumileds 2835, High CRI.
- Total Lumens: 5200LM Max
- Color Temperatures: 3000K/4000K/5000K
- Color Rendering Index: CRI ≥ 80
- Beam Angle: H127° x V85°
- Rated life: 70,000 Hrs

Applications:

- Entrance Lighting
- Courtyard Lighting
- Industrial Lighting
- Outdoor Landscape Lighting
- Building The hotel
- Wall Lighting Area And So On

Other Models:

• 80W | 10400LM | WPFX-MD-40-80W-MCTP-P

• 120W | 15600LM | WPFX-LG-80-120W-MCTP-P



Photometrics: WPFX-MD-20-40W-MCTP-P

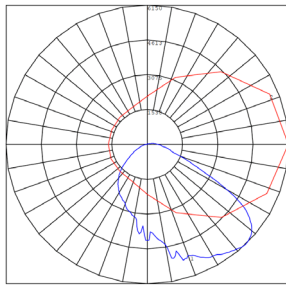
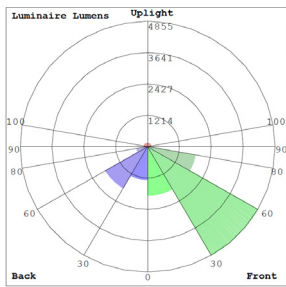

BUD Rating: B3-U3-G3

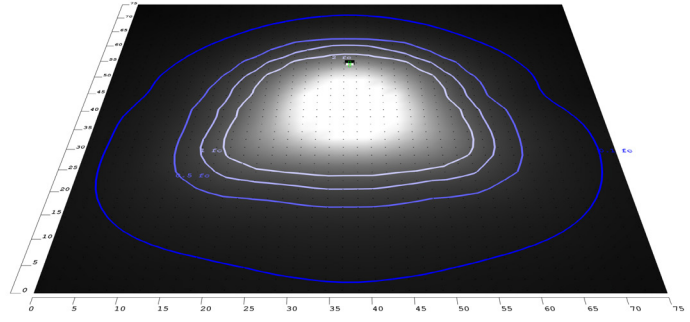

Area 75'x 75' Mounting Height: 8'

Other Views:



Side View



Front View



Back View

Performance Table: WPFX-MD-20-40W-MCTP-P

MODEL NO.	Wattage	Voltage	Lumens	Color Temp.	BUG Rating	LPW
WPFX-MD-20-40W-MCTP-P	20W	120~277V	3100LM	3000K 4000K 5000K	B3-U3-G3	130
	30W		3900LM			
	40W		5200LM			

Sample Ordering

Model	Size	Min.	Wattage	Color Temp.						
WPFX	-	MD	-	20	-	40W	-	MCTP	-	P

Factory-Installed Option:

Blank = No Option For Accessories
 OPT-EM-OD1INT = INTERNAL EMERGENCY BACK UP BATTERY
 OPT-SEN-3MRLV-5 = PROGRAMMABLE MICROWAVE SENSOR
 OPT-WP-480V = CHANGE VOLTAGE TO 480V

FACTORY-INSTALLED OPTION:



OPT-EM-OD1INT



OPT-SEN-3MRLV-5



COLOR CHART: * Choose from one of our Premium Colors with no set-up fee.

Gloss:



SILVER METALLIC
70 GLOSS
T357-GR105



SILVER METALLIC
30 GLOSS
T353-GR06



DARK RED 90
GLOSS
P009-RD02



INTERNATIONAL
ORANGE 90
GLOSS
T009-OG26



SAFETY ORANGE
90 GLOSS
T009-OG01



YELLOW 90
GLOSS
T009-YL14



YELLOW 90
GLOSS
T009-YL01



TRAFFIC GREEN
70 GLOSS
T007-GN16



GREEN 70 GLOSS
T007-GN13



GREEN 60 GLOSS
C006-GN03



BLUE 90 GLOSS
T009-BL01



DARK BLUE 80
GLOSS
T008-BL20



RAL 8028 TERRA
BROWN 90 GLOSS
C209-BR358

Hammer:



WHITE HAMMER
T013-WH09



BEIGE HAMMER
T013-BG38



GREY HAMMER
C013-GR08

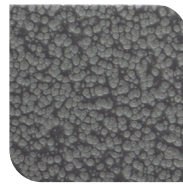

SILVER
HAMMERTONE
T064-GR05



BLACK HAMMER
T013-BK62

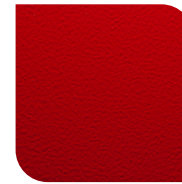

RED HAMMER
T013-RD15

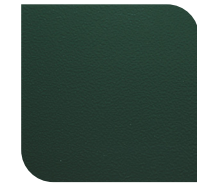

GREEN HAMMER
T013-GN220



BLUE HAMMER
T013-BL468



BRONZE HAMMER
T012-BR161

Texture:



WHITE TEXTURE
C031-WH120



FLINT GRAY
TEXTURE
T243-GR522



BLACK TEXTURE
C241-BK109



RED TEXTURE
T241-RD129



BLUE TEXTURE
C241-BL544

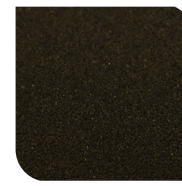

OIL RUBBED
BRONZE TEXTURE
T291-BR251

Vein:



BLACK/WHITE
VEIN
T075-WH34



SILVER VEIN
T375-BK26



COPPER VEIN
EXTERIOR
T075-BK211



GOLD VEIN
T375-BK10



COPPER VEIN
T375-BK07

