

TRE SERIES Commercial Lighting

TRE-25-35W-MCTP-36D-BK

TRE-25-35W-MCTP-36D-WH

BUILDER SERIES TRACK HEADS WITH EXT. DRIVERS, POWER AND CCT ADJUSTABLE

MCTP Multi Color Temperature & Multi Power/Wattage (Selectable)



Customer Name: _____

Project Name: _____

Note: _____

Type: _____

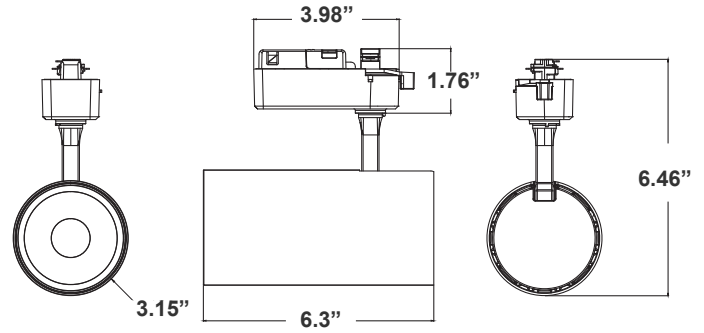

6.3" (W) x 6.46" (H) x 3.15" (D)

the Builder Series Track Heads

– the ultimate versatile and efficient lighting solution designed to meet the diverse needs of modern lighting projects. With an array of adjustable features, elegant finishes, and superior performance, the Builder Series Track Heads are perfect for any space requiring high-quality, adaptable lighting.

Features

- High Light Transmittance, Anti-UV and Fire Resistant PC Lens
- 7-Year Warranty
- Die-Cast Aluminum With Powder Coat Finish
- Multi CCT and Power (Switches Are On The Driver Box)

Technical Specifications

Electrical:

- Voltage: 120V AC 60Hz
- Wattage: 25W/30W/35W
- Power Factor: >0.95
- Efficacy: 84 LPW

Mechanical:

- Die-Cast Aluminum, Powder Coated Finish
- 90° vertical adjustment, 358° rotation
- Effortlessly installed into H-Type single-circuit track
- Operating Temperature: -4°F to 104°F
- Full Cutoff, Dark Sky Compliant
- IP 65, Wet Location
- 7-Year Warranty

Lighting:

- Multi CCT and Power (Switches Are On The Driver Box)
- The Type III Distribution Is Used for Wide Walkways, on Ramps and Entrance Roadways, As Well As Other Long, Narrow Lighting
- Total Lumens: 2940LM Max.
- Color Temperatures: 3000K/3500K/4000K
- Color Rendering Index: CRI ≥ 80
- Beam Angle: 36°
- Rated Life: 70,000 Hrs

Applications:

- Retail Stores: Enhance product displays with adjustable lighting that draws attention and creates a welcoming shopping experience.
- Galleries and Museums: Showcase artwork with precision lighting that can be easily adjusted to suit different exhibits.
- Commercial Spaces: Provide flexible lighting solutions that can adapt to changing needs and layouts.

Other Models:

- 15W | 1260LM | TRE-5-15W-MCTP-36D-BK
- 15W | 1260LM | TRE-5-15W-MCTP-36D-WH
- 25W | 2100LM | TRE-15-25W-MCTP-36D-BK
- 25W | 2100LM | TRE-15-25W-MCTP-36D-WH



Photometrics: TRE-25-35W-MCTP-36D

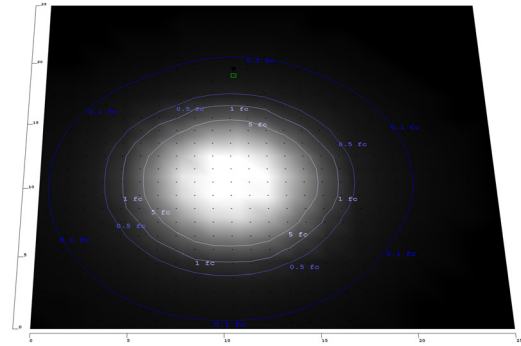
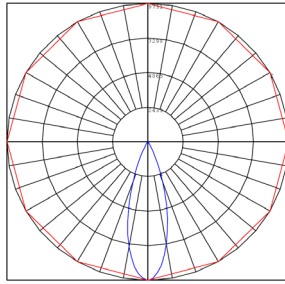

Area 25'x 25' Mounting Height: 9'

Other Views:



Side View



Side View

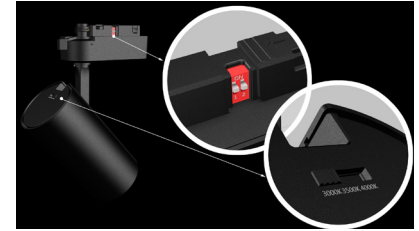

Switch View

Performance Table: TRE-25-35W-MCTP-36D

MODEL NO.	Wattage	Voltage	Lumens	Color Temp.	LPW
TRE-25-35W-MCTP-36D-BK	25W	120V	2125LM	3000K	84
TRE-25-35W-MCTP-36DWH	30W		2550LM	3500K	
	35W		2975LM	4000K	

Sample Ordering

Model Wattage. Wattage. Color Temp Beam Angle Housing

TRE - 25 - 35W - MCTP - 36D -

BK = BLACK
WH = WHITE

Accessories:

Blank = No Option For Accessories

- TR-2FT-BK = 2Ft 3-Wire Track, Black
- TR-2FT-WH = 2Ft 3-Wire Track, White
- TR-4FT-BK = 4Ft 3-Wire Track, Black
- TR-4FT-WH = 4Ft 3-Wire Track, White
- TR-6FT-BK = 6Ft 3-Wire Track, Black
- TR-6FT-WH = 6Ft 3-Wire Track, White
- TR-8FT-BK = 8Ft 3-Wire Track, Black
- TR-8FT-WH = 8Ft 3-Wire Track, White
- TR-LE-BK = 3-Wire Track Live End, Black
- TR-LE-WH = 3-Wire Track Live End, White
- TR-MC-BK = 3-Wire Track Mini Connector, Black
- TR-MC-WH = 3-Wire Track Mini Connector, White
- TR-SC-BK = 3-Wire Track Straight Connector, Black
- TR-SC-WH = 3-Wire Track Straight Connector, White
- TR-LC-BK = 3-Wire Track L Connector, Black
- TR-LC-WH = 3-Wire Track L Connector, White

- TR-TC-BK = 3-Wire Track T Connector, Black
- TR-TC-WH = 3-Wire Track T Connector, White
- TR-XC-BK = 3-Wire Track X Connector, Black
- TR-XC-WH = 3-Wire Track X Connector, White
- TR-FLEXC-BK = 3-Wire Track Flex Connector, Black
- TR-FLEXC-WH = 3-Wire Track Flex Connector, White
- TR-FC-BK = 3-Wire Track Floating Canopy, Black
- TR-FC-WH = 3-Wire Track Floating Canopy, White
- TR-MONC-BK = 3-Wire Track Mono Canopy, Black
- TR-MONC-WH = 3-Wire Track Mono Canopy, White
- TR-JBEF-BK = 3-Wire Track J-Box End Feed Kit, Black
- TR-JBEF-WH = 3-Wire Track J-Box End Feed Kit, White
- TR-CCON-BK = 3-Wire Track Conduit Connector, Black
- TR-CCON-WH = 3-Wire Track Conduit Connector, White
- TR-EC-BK = 3-Wire Track End Cap, Black
- TR-EC-WH = 3-Wire Track End Cap, White
- TR-EXTCON-BK = 3-Wire Track To Track Extension Connector, Black
- TR-EXTCON-WH = 3-Wire Track To Track Extension Connector, White
- TR-PENDKIT-BK = 3-Wire Track 3Ft Pendant Wiring Kit, Black
- TR-PENDKIT-WH = 3-Wire Track 3Ft Pendant Wiring Kit, White



Accessories: TRD-30W-MCT5-36D

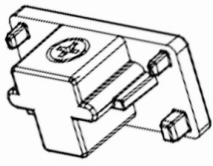

End Cap
TR-EC-BK
TR-EC-WH

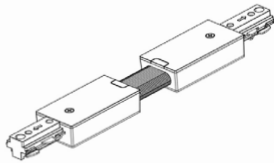

Flexible Connector
TR-FLEXC-BK
TR-FLEXC-WH

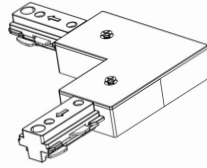

L Connector
TR-LC-BK
TR-LC-WH

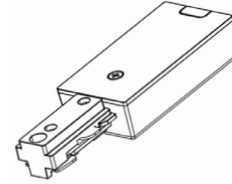

Live End Connector
TR-LE-BK
TR-LE-WH

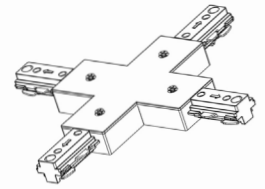

X Connector
TR-XC-BK
TR-XC-WH

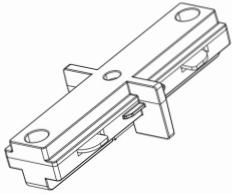

Mini Joiner
TR-MC-BK
TR-MC-WH

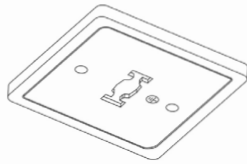

Monopoint Canopy
TR-MONC-BK
TR-MONC-WH

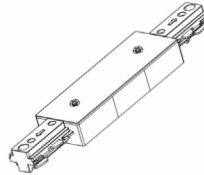

Stratght Connector
TR-SC- BK
TR-SC-WH

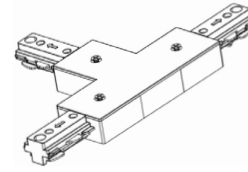

T Connector
TR-TC-BK
TR-TC-WH



Track Floating
TR-FC-BK
TR-FC-WH



Track
TR-2FT-BK
TR-2FT-WH
TR-4FT-BK
TR-4FT-WH
TR-6FT-BK
TR-6FT-WH
TR-8FT-BK
TR-8FT-WH

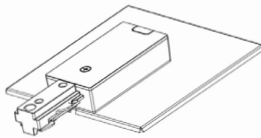

3-WIRE Track J-BOX
Eed Feed Kit
TR-JBEF-BK
TR-JBEF-WH

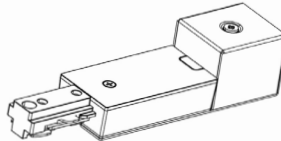

Live End Connector
with Box
TR-CCON-BK
TR-CCON-WH

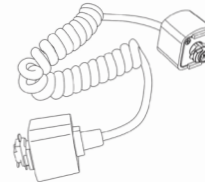

Track to Track Extension
Connector
TR-EXTCON-BK
TR-EXTCON-WH

