

TRD SERIES Commercial Lighting

TRD-8W-MCT5-36D-BK
TRD-8W-MCT5-36D-WH
SPEC SERIES DIE-CAST TRACK HEADS 5CCT + TRACKS AND ACCESSORIES
MCT5 Multi Color Temperature (Selectable)

Customer Name: _____
Project Name: _____
Note: _____ | Type: _____

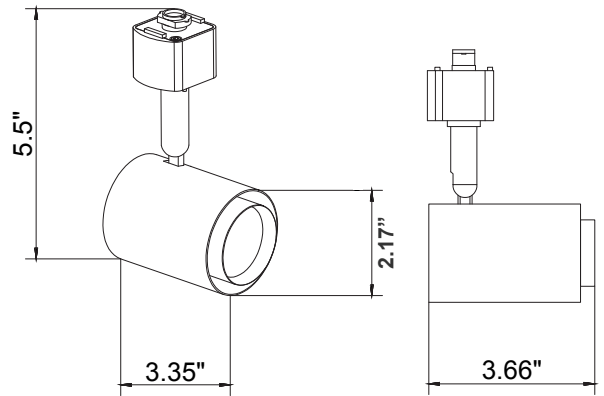
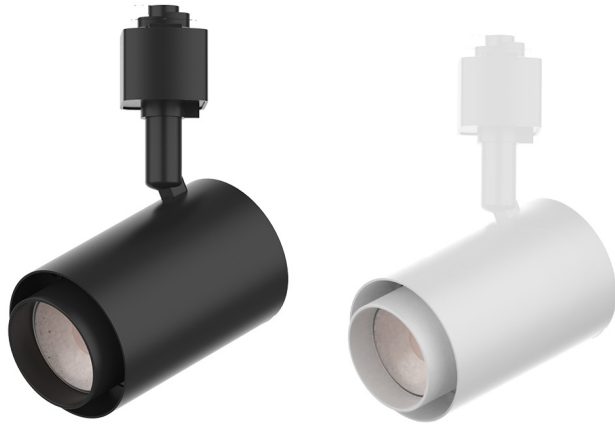

3.66" (W) x 5.5" (H) x 3.35" (D)

the Builder Series Track Heads – the ultimate versatile and efficient lighting solution designed to meet the diverse needs of modern lighting projects. With an array of adjustable features, elegant finishes, and superior performance, the Builder Series Track Heads are perfect for any space requiring high-quality, adaptable lighting.

Features

- High Light Transmittance, Anti-UV and Fire Resistant PC Lens
- 7-Year Warranty
- Die-Cast Aluminum With Powder Coat Finish
- Multi CCT (Switches Are On The Driver Box)

Technical Specifications

Electrical:

- Voltage: 120VAC 60Hz
- Wattage: 8W
- Power Factor: >0.95
- Efficacy: 90 LPW

Mechanical:

- Die-Cast Aluminum, Powder Coated Finish
- 90° vertical adjustment, 358° rotation
- Lens: Clear Tempered Glass Lens Secured To Housing By Threaded Lens Cap
- Maximum Weight for Each 2FT Track is 9 Lbs.
- Maximum Load For Each 2FT Track:
 - 15 Amp Circuit: 1800 Watts
 - 20 Amp Circuit: 2400 Watts
- Effortlessly installed into H-Type single-circuit track
- Operating Temperature: -4°F to 104°F
- 7-Year Warranty

Lighting:

- Multi CCT (Switches Are On The Driver Box)
- Total Lumens: 720LM
- Color Temperatures: 2700K/3000K/3500K/4000K/5000K
- Color Rendering Index: CRI ≥ 80
- Beam Angle: 36°
- Rated Life: 70,000 Hrs

Applications:

- Retail Stores: Enhance product displays with adjustable lighting that draws attention and creates a welcoming shopping experience.
- Galleries and Museums: Showcase artwork with precision lighting that can be easily adjusted to suit different exhibits.
- Commercial Spaces: Provide flexible lighting solutions that can adapt to changing needs and layouts.

Other Models:

- 12W | 1080LM | TRD-12W-MCT5-36D-BK • 20W | 1800LM | TRD-20W-MCT5-36D-BK • 30W | 2700LM | TRD-30W-MCT5-36D-BK
- 12W | 1080LM | TRD-12W-MCT5-36D-WH • 20W | 1800LM | TRD-20W-MCT5-36D-WH • 30W | 2700LM | TRD-30W-MCT5-36D-WH



Photometrics: TRD-8W-MCT5-36D

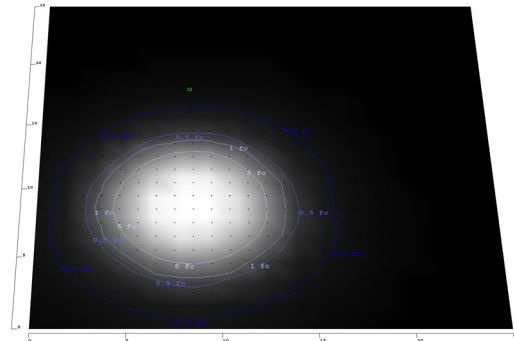
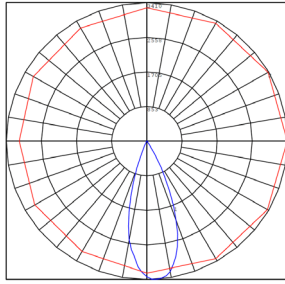

Area 25'x 25' Mounting Height: 9'

Other views: TRD-8W-MCT5-36D-BK



Side View



Back View



Switch View



Side View



Back View



Switch View

Performance Table: TRD-8W-MCT5-36D

MODEL NO.	Wattage	Voltage	Lumens	Color Temp.	LPW
TRD-8W-MCT5-36D-BK TRD-8W-MCT5-36D-WH	8W	120V	720LM	2700K 3000K 3500K 4000K 5000K	90

Sample Ordering

Model Wattage.Color TempBeam Angle Housing

TRD - 8W - MCT5 - 36D -

BK = BLACK
WH = WHITE

Accessories:

- Blank = No Option For Accessories
- TR-2FT-BK = 2Ft 3-Wire Track, Black
- TR-2FT-WH = 2Ft 3-Wire Track, White
- TR-4FT-BK = 4Ft 3-Wire Track, Black
- TR-4FT-WH = 4Ft 3-Wire Track, White
- TR-6FT-BK = 6Ft 3-Wire Track, Black
- TR-6FT-WH = 6Ft 3-Wire Track, White
- TR-8FT-BK = 8Ft 3-Wire Track, Black
- TR-8FT-WH = 8Ft 3-Wire Track, White
- TR-LE-BK = 3-Wire Track Live End, Black
- TR-LE-WH = 3-Wire Track Live End, White
- TR-MC-BK = 3-Wire Track Mini Connector, Black
- TR-MC-WH = 3-Wire Track Mini Connector, White
- TR-SC-BK = 3-Wire Track Straight Connector, Black
- TR-SC-WH = 3-Wire Track Straight Connector, White
- TR-LC-BK = 3-Wire Track L Connector, Black
- TR-LC-WH = 3-Wire Track L Connector, White

- TR-TC-BK = 3-Wire Track T Connector, Black
- TR-TC-WH = 3-Wire Track T Connector, White
- TR-XC-BK = 3-Wire Track X Connector, Black
- TR-XC-WH = 3-Wire Track X Connector, White
- TR-FLEXC-BK = 3-Wire Track Flex Connector, Black
- TR-FLEXC-WH = 3-Wire Track Flex Connector, White
- TR-FC-BK = 3-Wire Track Floating Canopy, Black
- TR-FC-WH = 3-Wire Track Floating Canopy, White
- TR-MONC-BK = 3-Wire Track Mono Canopy, Black
- TR-MONC-WH = 3-Wire Track Mono Canopy, White
- TR-JBEF-BK = 3-Wire Track J-Box End Feed Kit, Black
- TR-JBEF-WH = 3-Wire Track J-Box End Feed Kit, White
- TR-CCON-BK = 3-Wire Track Conduit Connector, Black
- TR-CCON-WH = 3-Wire Track Conduit Connector, White
- TR-EC-BK = 3-Wire Track End Cap, Black
- TR-EC-WH = 3-Wire Track End Cap, White
- TR-EXTCON-BK = 3-Wire Track To Track Extension Connector, Black
- TR-EXTCON-WH = 3-Wire Track To Track Extension Connector, White
- TR-PENDKIT-BK = 3-Wire Track 3Ft Pendant Wiring Kit, Black
- TR-PENDKIT-WH = 3-Wire Track 3Ft Pendant Wiring Kit, White

Beam Lens Accessories:

- TRD-8W-LENS-15D = TRD Replacement Lens 15 Degree
- TRD-8W-LENS-25D = TRD Replacement Lens 25 Degree
- TRD-8W-LENS-55D = TRD Replacement Lens 55 Degree



Accessories: TRD-30W-MCT5-36D

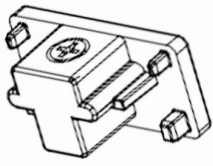

End Cap
TR-EC-BK
TR-EC-WH

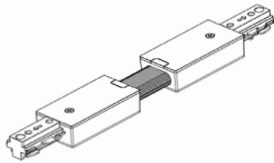

Flexible Connector
TR-FLEXC-BK

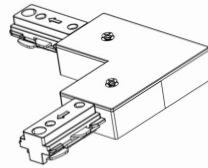

L Connector
TR-LC-BK
TR-LC-WH

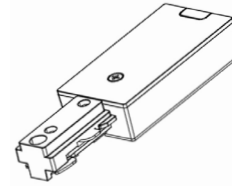

Live End Connector
TR-LE-BK
TR-LE-WH

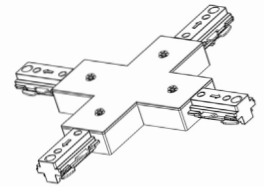

X Connector
TR-XC-BK
TR-XC-WH

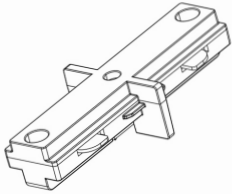

Mini Joiner
TR-MC-BK
TR-MC-WH

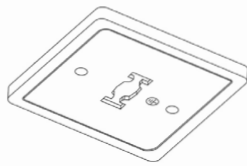

Monopoint Canopy
TR-MONC-BK
TR-MONC-WH

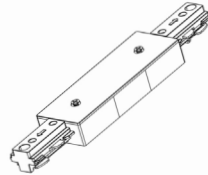

Straight Connector
TR-SC-BK
TR-SC-WH

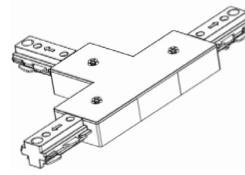

T Connector
TR-TC-BK
TR-TC-WH

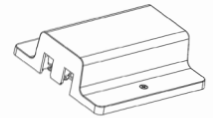

Track Floating
TR-FC-BK
TR-FC-WH



Track
TR-2FT-BK
TR-2FT-WH
TR-4FT-BK
TR-4FT-WH
TR-6FT-BK
TR-6FT-WH
TR-8FT-BK
TR-8FT-WH

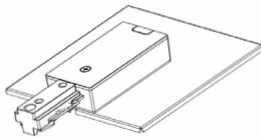

3-WIRE Track J-BOX
Eed Feed Kit
TR-JBEF-BK
TR-JBEF-WH

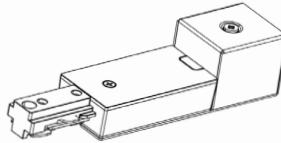

Live End Connector
with Box
TR-CCON-BK
TR-CCON-WH

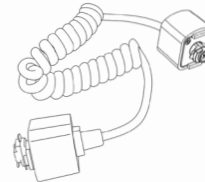

Track to Track
Extension
Connector
Extends 16" to 48"
TR-EXTCON-BK
TR-EXTCON-WH

Compatible Dimmer List:

MODEL NO.	BRAND	MODEL NO.	BRAND
DVCL-153P	DIVA	DVELV-300P	DIVA
IP106	LEVITON	TGCL-153P	Toggler
IP1160	LEVITON	6633-P	LEVITON
S-600	SKYL^RK	6613-P	LEVITON
MS-OP600G	MAESTRO	MS-OP600G	SKYL^RK
MLV-600	COOPER	CTCL-153P	COOPER

