

JOB NAME: _____

DATE: _____

TYPE: _____

DIMENSIONS:

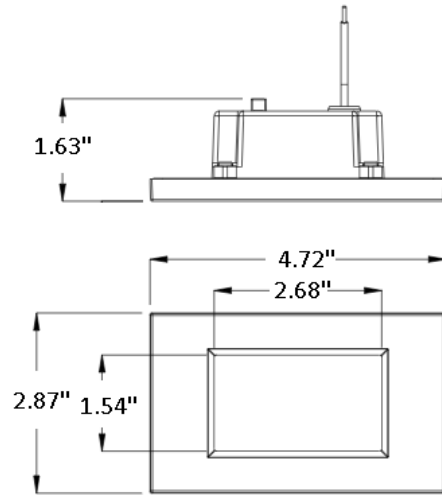
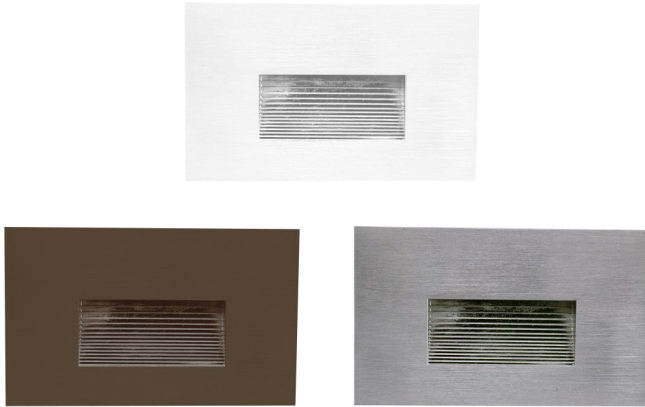

SLE-A-12V-MCT-WH
SLE-A-12V-MCT-ORB
SLE-A-12V-MCT-BN



**MODEL A - 12V SELECTABLE CCT LED
INTEGRATED STEP LIGHTS**

Ideal for recessed step lighting, walkway and path lighting, courtyard lighting and deck lighting. Optional face plates sold separately.

ELECTRICAL SPECIFICATIONS:

- Voltage: 12V AC
- Wattage: 3.5W
- Efficacy: 15LM/W~29LM/W

HOUSING SPECIFICATIONS:

- polycarbonate housing
- White or Oli-Rubbed Bronze or Brushed Nickel Finish
- Frosted inside of glass lens
- Operating temperature: -40°F ~ 104°F
- Lifespan: 50000 Hrs.
- IP rating: IP65, Wet Locations

CERTIFICATIONS:



MODEL	WATTS	VOLTAGE	LUMENS	COLOR TEMP
SLE-A-12V-MCT-WH	3.5W	12V AC	100LM	MCT
SLE-A-12V-MCT-ORB	3.5W	12V AC	50LM	MCT
SLE-A-12V-MCT-BN	3.5W	12V AC	50LM	MCT

LIGHTING SPECIFICATIONS:

- LED type: Integrated SMD LED Module
- Total lumens: 100LM/50LM/50LM
- Color temperature: 3000K/4000K/5000K
- Beam angle: 120°

WARRANTY: 3 years

