

# SCX SERIES

Commercial Lighting

**WESTGATE**  
THE FUTURE IS HERE...AND IT'S QUITE BRIGHT!

SCX1.5-8FT-UD-MCTP5-D

**MCTP** Multi Color Temperature (Selectable)

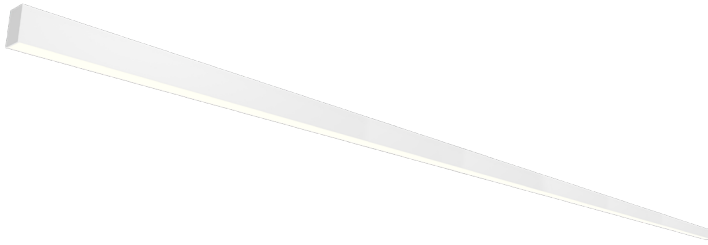

Customer Name: \_\_\_\_\_

Project Name: \_\_\_\_\_

Note: \_\_\_\_\_

Type: \_\_\_\_\_

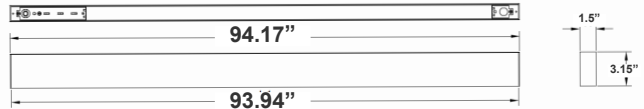

94.17"(L) x 1.5"(W) x 3.15"(H)

The SCX series offers the best and the most comprehensive selection for linear lighting. The various available lengths and widths allow the creation of the desired shape to elevate the areas aesthetics to a unique and modern look while providing an impressive illumination for the occupants. Ideal for, retail locations, offices, lobbies, conference rooms, reception areas, hallways, educational facilities, hotels, and restaurants. FEATURES: Superior Architectural Look Energy-efficient: Low Wattage Consumption & High Lumen Output Easier Wire Management & Install Variety of Mounting Options Multi Color Temperature (Selectable Switch Inside Fixture) Variety Of Factory Customizations Available

## Features

- LED Superior Architectural Lights
- Seamless Linkable Linear Lighting System
- Opal Polycarbonate Lens-Direct (DOWN) Lighting
- Optional Recessed & Wall Mounting Kits Available
- Optional Louver Version Lens Available
- Lens Type: Opal Polycarbonate Lens
- MCT: Multi Color Temperature (Selectable Switch Inside Fixture)

## Technical Specifications

### Electrical:

- Voltage: 120-277VAC 50/60Hz
- Wattage: 32W/44W/52W/60W
- Power Factor: >0.95
- Total Harmonic Distortion: ≤ 20 %
- LPW: 110

### Mechanical:

- Low Profile Modern Design
- Aluminum Housing With Matte Black Finish
- Custom Colors Available
- Seamless connection between straight fixtures requires SCX1.5-CONKIT internal connection bracket (sold separately).
- Lens Snaps into Housing
- Make Different Connections Via T/L/X Joints on Both Ends
- Mounting Options: Surface, Suspended, Wall, Recessed
- IP Rating: IP54
- Operating Temperature: -13°F~104°F
- Adjustable Suspension Brackets Provided on Top of The Fixtures
- 5-Year Warranty

### Lighting:

- Dimmable: 0~10V Dimming
- Total Lumens: 6600LM
- Color Temperatures: 2700K/3000K/3500K/4000K/5000K
- Multi-CCT(Selectable Switch Inside Fixture)
- Color Rendering Index: CRI ≥ 80
- Integrated upright module with selectable upright proportions
- 50,000 Hours Rated Life
- Beam Angle: 104.8°(H) x 100.5°(V)

### Applications:

- Ideal for offices, hotels, corridors, saloons, libraries, meeting rooms, conference halls, and the best solution for modern lighting solutions
- It can be used in any indoor applications



Phone: (877) 805-2252 | Fax: (877) 805-2252  
www.westgatemfg.com |



## Photometrics: SCX1.5-8FT-UD-MCTP5-D

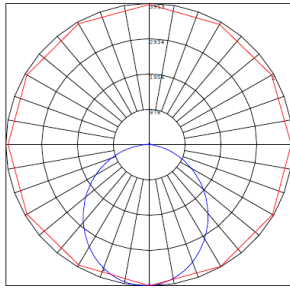
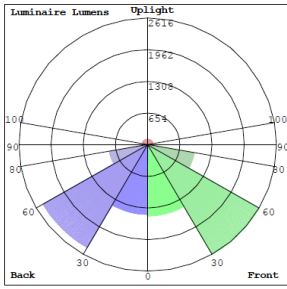

BUD Rating: B3-U3-G2

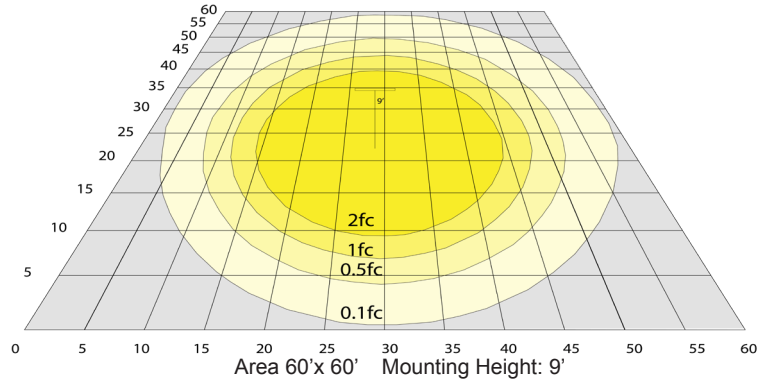

## Other Views:



Side View



Back View

## Performance Table: SCX1.5-8FT-UD-MCTP5-D

MODEL NO.	Wattage	Voltage	Lumens	Color Temp.	BUG Rating	LPW
SCX1.5-8FT-UD-MCTP5-D	32W 44W 52W 60W	120~277V	3520LM 4400LM 5720LM 6600LM	2700K 3000K 3500K 4000K 5000K	B3-U3-G2	110

## Sample Ordering

Model	Size	Wattage	Color Temp.	Feature
SCX1.5	8FT	80W	MCT5	D

## Accessories:

Blank = No Option For Accessories

**SCL-CS1-6FT** = ADJ. 6FT 1/16in SINGLE SUSPENSION CANOPY SET WITH KEYHOLE END CONNECTOR, NON-POWER SIDE

**SCL-CS1P-6FT** = ADJ. 6FT 1/16in SINGLE SUSPENSION CANOPY SET WITH KEYHOLE END CONNECTOR, POWER SIDE WITH SJTW18/5 WHITE CORD

**SCL-CS1P-6FT-NC** = ADJ. 6FT 1/16in SINGLE SUSPENSION CANOPY SET WITH KEYHOLE END CONNECTOR

**SCL-CSK-6FT** = ADJ. 6FT 1/16in SUSPENSION CANOPY COMPLETE KIT FOR BOTH SIDES WITH KEYHOLE END CONNECTORS

**SCL-GS10** = ADJ. 10FT 1/16in DOUBLE SUSPENSION CABLE WITH SINGLE KEYHOLE CONN., LOOP GRIPPER ON TOP

**SCL-GS20** = ADJ. 20FT 1/16in DOUBLE SUSPENSION CABLE WITH SINGLE KEYHOLE CONN., LOOP GRIPPER ON TOP

**SCL-6FT-SJTW18/5** = 6ft White Cord, SJTW 18 AWG 5-Conductor (Black, White, Green + Purple & Gray for 0-10V Dimming)

**SCL-6FT-SJTW18/5-100FT** = 100ft Roll of White Cord, SJTW 18 AWG 5-Conductor (Black, White, Green + Purple & Gray for 0-10V Dimming)

**SCL-6FT-SJTW18/5-100FT-BK** = 100ft Roll of Black Cord, SJTW 18 AWG 5-Conductor (Black, White, Green + Purple & Gray for 0-10V Dimming)

**SCL-6FT-SJTW18/6-100FT** = 100ft Roll of Black Cord, SJTW 18 AWG 6-Conductor (Black, White, Green + Purple & Gray for 0-10V Dimming + Red for Backup Invertor)

**SCL-AH** = Heavy-Duty Auxiliary Hook for Up To 1/16" Aircraft Cable

**SCL-ASC-500FT** = 1/16" 500 ft. Steel Aircraft Cable Suspension

## SUSPENDED MOUNTING ACCESSORIES (NOT INCLUDED)

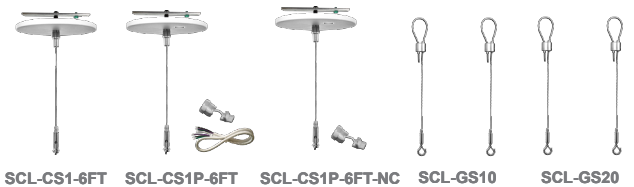

## FACTORY-INSTALLED OPTIONS:



## Factory-Installed Options:

Blank = No Option For Accessories

**OPT-HBC-125BS-BK** = 10FT, 15A, 125V, 18/3 STR, BLACK



# MOUNTING AND MODULES OPTIONS:



\*Seamless connection shown requires SCX1.5-CONKIT internal connection bracket (sold separately)

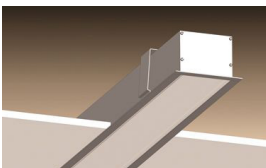

Recessed Mounted (Flanged)



Surface Mounted



Wall Mounted



Suspended

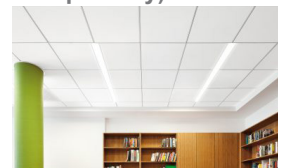

T-Bar Installation

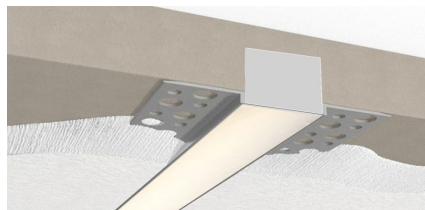

Flangless Recessed Mounted (Mud-In)

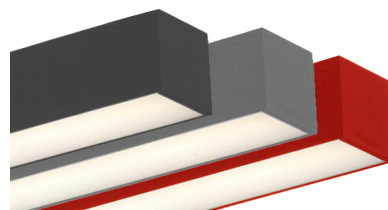

Color of Your Choice

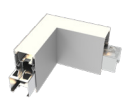

L Module

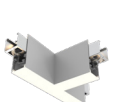

T Module



X Module



Inside Corner Module



120° Corner Module



Y Module



C60 Module



OC Module



6in Module



9in Module

SCX1.5-L-UD-MCT5 SCX1.5-T-UD-MCT5 SCX1.5-X-UD-MCT5 SCX1.5-IC-UD-MCT5 SCX1.5-C120-UD-MCT5 SCX1.5-Y-UD-MCT5 SCX1.5-C60-UD-MCT5 SCX1.5-OC-UD-MCT5 SCX1.5-6IN-UD-MCT5 SCX1.5-9IN-UD-MCT5



## MOUNTING OPTIONS:

### FLANGLESS RECESSED INSTALLATION IN WOOD CEILING

No additional accessories required.  
 Make recessed preparations by installing a horizontal plank of wood on top of the wood ceiling at a recessed height of 3 3/8".  
 Screw and anchor kit provided with each fixture can be used to fasten the top of the fixture to the wood plank through the holes on top of the fixture.  
 You can also install vertical wood boards on top of the ceiling at the edge of the opening and open the fixture and put screws through the side of the fixture housing to fasten it to the wood boards.



\*Seamless connection shown requires SCX1.5-CONKIT internal connection bracket (sold separately)

### SUSPENSION ROD KITS (SET OF 2)

Model	SIZE
SCL-RS-12	12 IN
SCL-RS-18	18 IN
SCL-RS-24	24 IN
SCL-RS-36	36 IN
SCL-RS-48	48 IN



### WALL MOUNTING

Model	DESCRIPTION
OPT-SCX1.5-WM-8FT	Install this optional wall mounting brackets on the back of the fixture. Connection cables will enter the fixture through one of these wall-mounting brackets. On your purchase order, please specify the position of where your wire entry from the wall.

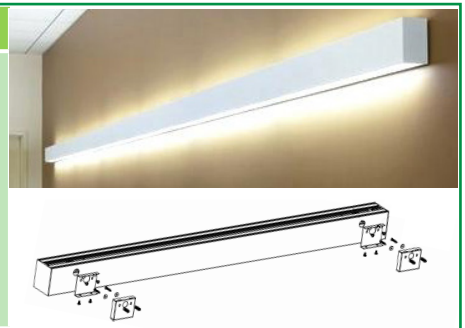

### WALL MOUNTING

Model	DESCRIPTION
OPT-SCX1.5-WMA-8FT	Add this option to the fixture, and wall mounting arms with a wall canopy will be installed on the back of the fixture. The length of each arm is 5". Connection cables will enter the fixture through one of the arms. On your purchase order, specify the position of your wire entry from the wall, and the arm will be installed on the back accordingly.

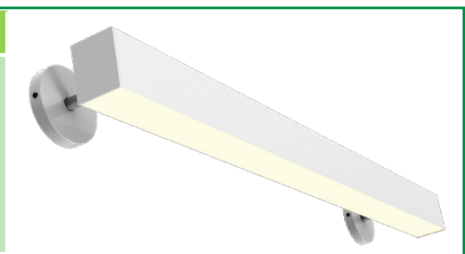

### RECESSED MOUNT WITH FLANGE

Model	DESCRIPTION
OPT-SCX1.5-FMR-8FT	Order this option and the fixture will be equipped with a 1/2" wide flange on four sides. Advanced design toggle-style brackets will also be provided, to adjust and hold the fixture against drywall or other hard ceilings from the top. When linking to another fixture or corner module, call us or send a copy of your plan along with your PO, and flanges will be removed on those ends that need to make a seamless connection.

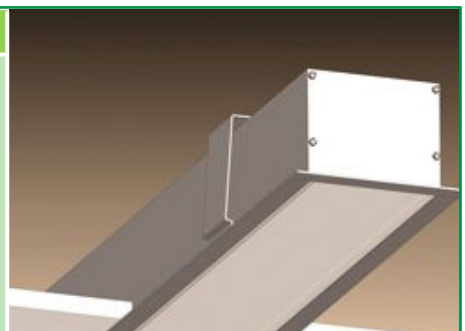

\*Seamless connection shown requires SCX1.5-CONKIT internal connection bracket (sold separately)



## FLANGELESS RECESS MOUNT IN DRYWALL (MUD-IN)

Model	DESCRIPTION
OPT-SCX1.5-MIF-8FT	Order this option and the fixture will be equipped with mud-in brackets on all four sides, mounted at 1/16" from the lens surface (specify if other spacing is needed). Advanced design toggle-style brackets will also be provided, to adjust and hold the fixture against the drywall ceiling from the top. When linking to another fixture or corner fixture module call us or send a copy of your plan along with your PO and flanges will be removed on those end that needs to make a seamless connection.
OPT-SCX-MIF-L	This is a L Module option.
OPT-SCX-MIF-T	This is a T Module option.
OPT-SCX-MIF-X	This is a X Module option.
OPT-SCX-MIF-IC	This is a Inside Corner Module option.

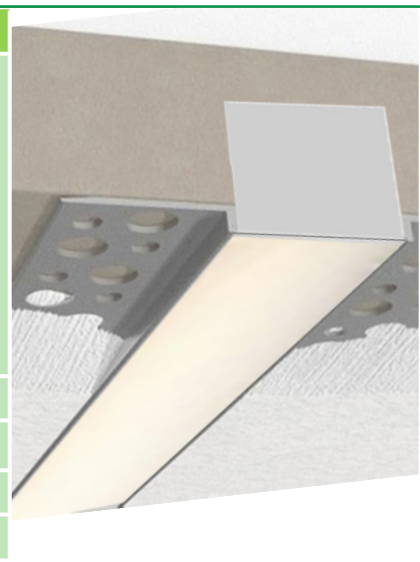

## T-BAR INSTALLATION

Model	DESCRIPTION
OPT-SCX1.5-TBAR-8FT	Add this option and 1/2" wide flanges will be installed on the two long sides of the fixture. The two ends of the fixture will fall onto the T-bar grids and will be supported this way. The T-bar tiles on the two sides of the fixture must be cut to allow for the width of the fixture. The tile will fall onto and be supported by the flanges on both sides of the fixture. If you plan to support the fixture by the grids on three sides and tile on one side, call us or specify on your PO, and flange will be installed only on one side of the fixture. To provide safety and support from the beams above the T-bar ceiling order 10ft or 20ft aircraft suspension kits below.
SCL-GS10	Adjustable 1/16" 10ft suspension kit with loop gripper & toggle ends hold up to 70 lbs load.
SCL-GS20	Adjustable 1/16" 20ft suspension kit with loop gripper & toggle ends hold up to 70 lbs load.
OPT-FWH-63	This is a 6FT 3-Wire Whip option.
OPT-FWH-65	This is a 6FT 5-Wire Whip option.
OPT-FWH-66	This is a 6FT 6-Wire Whip option.



\*Seamless connection shown requires SCX1.5-CONKIT internal connection bracket (sold separately)

## SURFACE MOUNTING

No additional accessories required.

Screw and anchor kit provided with each fixture can be used to fasten the fixture directly to the hard surface through the holes on top of the fixture.

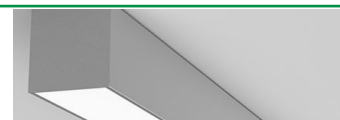

## SCX1.5-CONKIT

SCX1.5-CONKIT internal connection bracket required for seamless connection (sold separately)

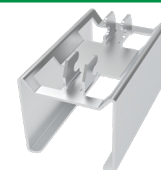

## FACTORY-INSTALLED OPTIONS:

### COLOR OF YOUR CHOICE

Model	DESCRIPTION
OPT-SCX-CLR-8FT	Add this option and specify your desired color on your purchase order or provide a swatch to match. For painted flanged fixture or optional rod, mounting set please also add the relevant option below for each fixture.
OPT-SCX-CLR-FRM	This is a painted flanges option
OPT-SCX-CLR-RODSET	This is a painted rod set option.

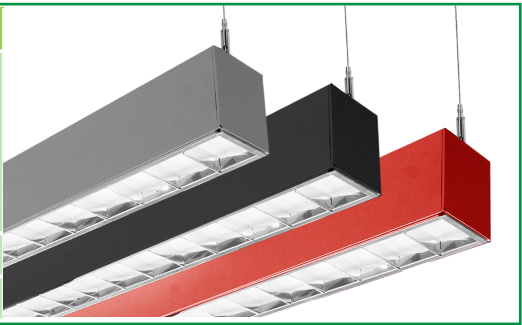

### EMERGENCY BATTERY BACKUP

Model	DESCRIPTION
OPT-EM-CM1INT	This is an option for a 90-minute backup battery installation. If you need to order this series for the fixture, please have your purchase order ready and call us or specify on the order which fixture to install this option and the test button.

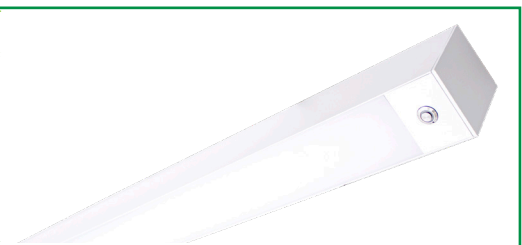

### BI-LEVEL MOTION SENSOR

Model	DESCRIPTION
OPT-SCX-SEN2US	This option installs an advanced motion sensor that will turn the lights on when the area is occupied. When the area is cleared, after a preset hold time of 5 sec or more the lights are dimmed to a standby level of 30% or more. If still no motion is detected, after the standby period, the light is turned off. All setting is programmable with a remote control.
OPT-WEC-3RC	This is an optional remote control for sensor.
OPT-SEN-SCX-2MRLV-5	This is a programmable microwave Bi-Level sensor.
OPT-SEN-2US-DAYLIGHT	It is an ultrasonic Bi-Level Dimming Daylight sensor option for internal installation inside the fixture. (Remote not needed)

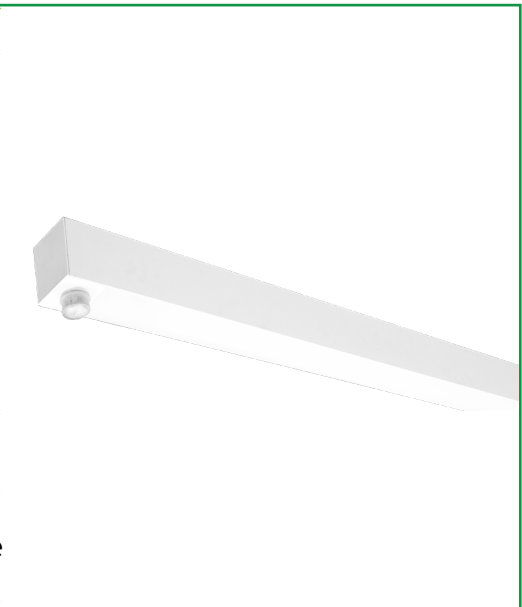



## T-BAR INSTALLATION

Model	DESCRIPTION	
OPT-SCX1.5-TBAR-8FT 8FT	<p>Add this option to the fixture, and 1/2" wide flanges will be installed on the two long sides of the fixture. The two fixture ends will fall onto the t-bar grids and will be supported this way. The t-bar tiles on the two sides of the fixture must be cut to allow for the fixture's width. The tiles will fall onto and be supported by the flanges on both sides of the fixture. If you plan to support the fixture by the grids on three sides and tile on one side, call us or specify on your po, and the flange will be installed only on one side of the fixture. To provide safety and support from the beams above the t-bar ceiling, order 10ft or 20ft aircraft suspension kits below.</p>	

\*Seamless connection shown requires SCX1.5-CONKIT internal connection bracket (sold separately)

## FIELD-INSTALLED FLANGED RECESSED MOUNT DRYWALL KIT

Model	DESCRIPTION	SIZE	
SCX1.5-FMRK-8FT	SCX-8Ft. Field-Installed Flanged Recessed Mount Drywall Kit	8FT	

## SCX1.5 FIELD-INSTALLED MUD-IN FLANGE-LESS RECESSED MOUNT KIT

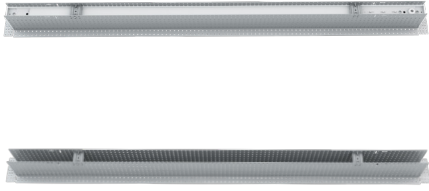
Model	DESCRIPTION	SIZE	
SCX1.5-MIFK-8FT	SCX-8Ft Field-Installed Mud-In Flange-Less Recessed Mount Kit	8FT	



## CORNER FIXTURE MODULES:

### Built-in LED Modules

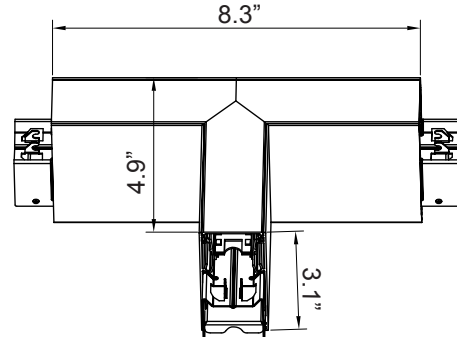
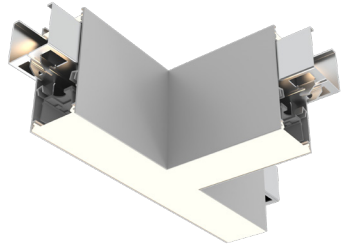

Model	JOINT TYPE	LUMENS	COLOR TEMP	DIMENSION
SCX1.5-T-UD-MCT5	T	629LM 726LM 787LM 854LM	2700kK 3000K 3500K 4000K 5000K	8.3" X 4.9" X 3.1"

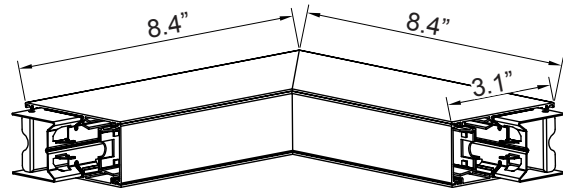
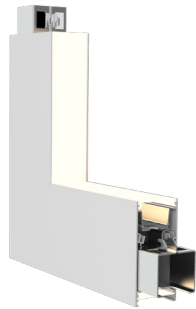

Model	JOINT TYPE	LUMENS	COLOR TEMP	DIMENSION
SCX1.5-IC-UD-MCT5	INSIDE CORNER	629LM 726LM 787LM 854LM	2700K 3000K 3500K 4000K 5000K	8.4" X 8.4" X 3.1"

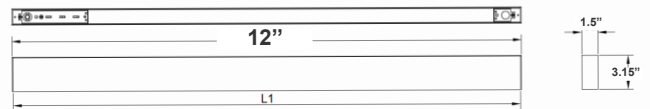
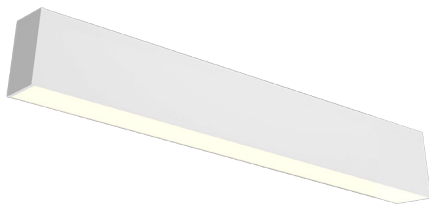

Model	JOINT TYPE	LUMENS	COLOR TEMP	DIMENSION
SCX1.5-1FT- UD-MCTP5	1FT Module	508LM 575LM 616LM 660LM	2700K 3000K 3500K 4000K 5000K	12" X 1.5" X 3.1"



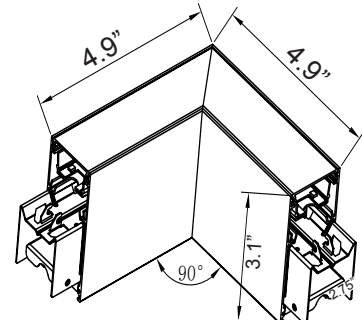
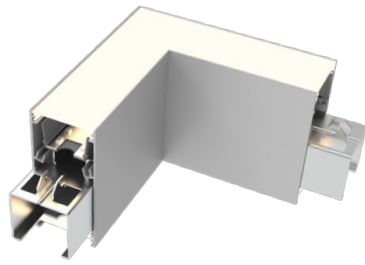

Model	JOINT TYPE	LUMENS	COLOR TEMP	DIMENSION
SCX1.5-L-UD-MCT5	L FIXTURE	2197LM 2316LM 2348LM 2390LM	2700K 3000K 3500K 4000K 5000K	4.9" X 4.9" X 3.1"

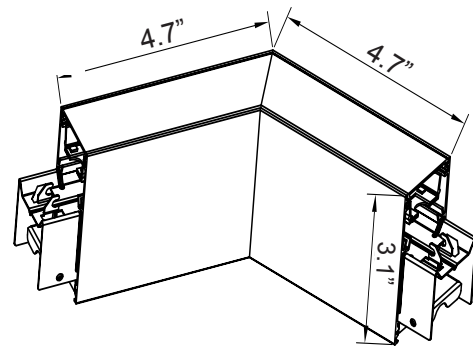
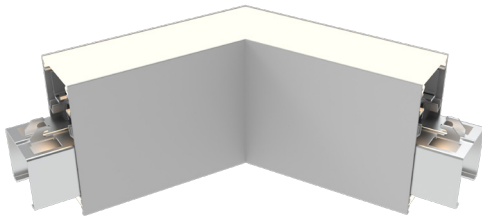

Model	JOINT TYPE	LUMENS	COLOR TEMP	DIMENSION
SCX1.5-C120-UD-MCT5	120° CORNER	508LM 575LM 616LM 660LM	2700K 3000K 3500K 4000K 5000K	4.7" X 4.7" X 3.1"

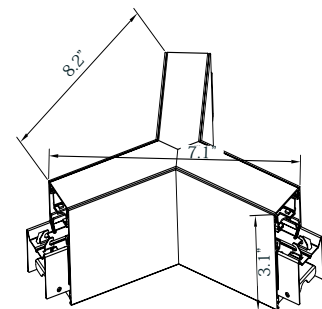
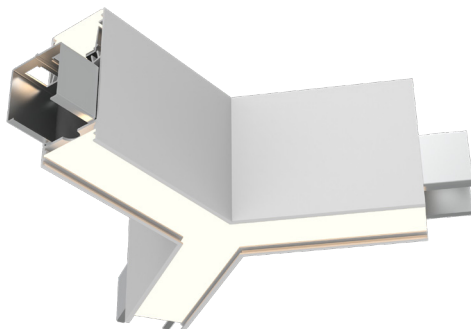

Model	JOINT TYPE	LUMENS	COLOR TEMP	DIMENSION
SCX1.5-Y-UD-MCT5	Y	508LM 575LM 616LM 660LM	2700K 3000K 3500K 4000K 5000K	8.2" X 7.1" X 3.1"



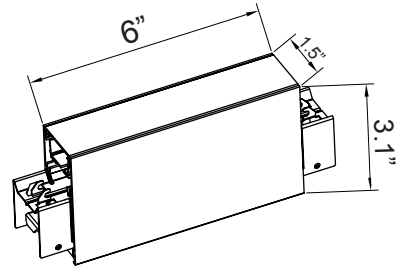
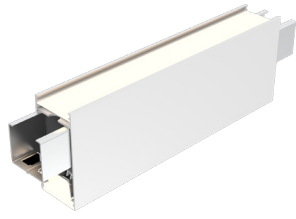

Model	JOINT TYPE	LUMENS	COLOR TEMP	DIMENSION
SCX1.5-6IN-UD-MCTS	6in Module	508LM 575LM 616LM 660LM	2700K 3000K 3500K 4000K 5000K	6" X 3.1" X 1.5"

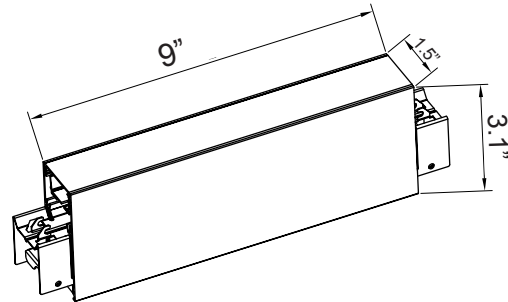
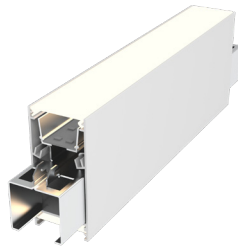

Model	JOINT TYPE	LUMENS	COLOR TEMP	DIMENSION
SCX1.5-9IN- UD-MCTS	9in Module	508LM 575LM 616LM 660LM	2700K 3000K 3500K 4000K 5000K	9" X 1.5" X 3.1"



**COLOR CHART:** \* Choose from one of our Premium Colors with no set-up fee.

**Gloss:**



SILVER METALLIC  
70 GLOSS  
T357-GR105



SILVER METALLIC  
30 GLOSS  
T353-GR06



DARK RED 90  
GLOSS  
P009-RD02



INTERNATIONAL  
ORANGE 90  
GLOSS  
T009-OG26



SAFETY ORANGE  
90 GLOSS  
T009-OG01



YELLOW 90  
GLOSS  
T009-YL14



YELLOW 90  
GLOSS  
T009-YL01

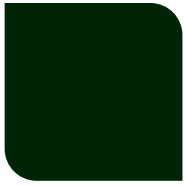

TRAFFIC GREEN  
70 GLOSS  
T007-GN16



GREEN 70 GLOSS  
T007-GN13



GREEN 60 GLOSS  
C006-GN03



BLUE 90 GLOSS  
T009-BL01



DARK BLUE 80  
GLOSS  
T008-BL20



RAL 8028 TERRA  
BROWN 90 GLOSS  
C209-BR358

**Hammer:**



WHITE HAMMER  
T013-WH09



BEIGE HAMMER  
T013-BG38



GREY HAMMER  
C013-GR08

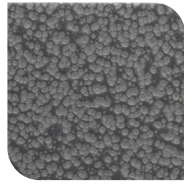

SILVER  
HAMMERTONE  
T064-GR05



BLACK HAMMER  
T013-BK62



RED HAMMER  
T013-RD15



GREEN HAMMER  
T013-GN220

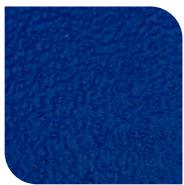

BLUE HAMMER  
T013-BL468



BRONZE HAMMER  
T012-BR161

**Texture:**



WHITE TEXTURE  
C031-WH120



FLINT GRAY  
TEXTURE  
T243-GR522



BLACK TEXTURE  
C241-BK109



RED TEXTURE  
T241-RD129



BLUE TEXTURE  
C241-BL544



OIL RUBBED  
BRONZE TEXTURE  
T291-BR251

**Vein:**



BLACK/WHITE  
VEIN  
T075-WH34



SILVER VEIN  
T375-BK26

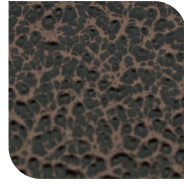

COPPER VEIN  
EXTERIOR  
T075-BK211



GOLD VEIN  
T375-BK10



COPPER VEIN  
T375-BK07

