

SCX SERIES

Commercial Lighting

WESTGATE
THE FUTURE IS HERE...AND IT'S QUITE BRIGHT!

SCX1.5-2FT-UD-MCTP5-D-BK

MCTP Multi Color Temperature (Selectable)

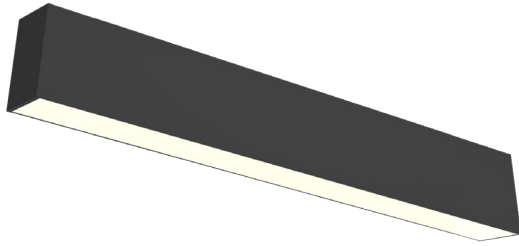

Customer Name: _____

Project Name: _____

Note: _____

Type: _____

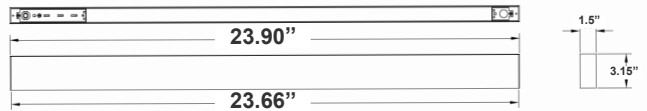

23.90"(L) x 1.5"(W) x 3.15"(H)

The SCX series offers the best and the most comprehensive selection for linear lighting. The various available lengths and widths allow the creation of the desired shape to elevate the areas aesthetics to a unique and modern look while providing an impressive illumination for the occupants. Ideal for, retail locations, offices, lobbies, conference rooms, reception areas, hallways, educational facilities, hotels, and restaurants. FEATURES: Superior Architectural Look Energy-efficient: Low Wattage Consumption & High Lumen Output Easier Wire Management & Install Variety of Mounting Options Multi Color Temperature (Selectable Switch Inside Fixture) Variety Of Factory Customizations Available

Features

- LED Superior Architectural Lights
- Seamless Linkable Linear Lighting System
- Opal Polycarbonate Lens-Direct (DOWN) Lighting
- Optional Recessed & Wall Mounting Kits Available
- Optional Louver Version Lens Available
- Lens Type: Opal Polycarbonate Lens
- MCT: Multi Color Temperature (Selectable with Switch Inside Fixture)

Technical Specifications

Electrical:

- Voltage: 120-277VAC 50/60Hz
- Wattage: 8W/11W/13W/15W
- Power Factor: >0.95
- Total Harmonic Distortion: ≤ 20 %
- Efficacy: 110 LPW

Mechanical:

- Low Profile Modern Design
- Aluminum Housing With Matte Black Finish
- Custom Colors Available
- Lens Snaps into Housing
- Make Different Connections Via T/L/X Joints on Both Ends
- Mounting Options: Surface, Suspended, Wall, Recessed
- IP Rating: IP54
- Seamless connection between straight fixtures requires SCX1.5-CONKIT internal connection bracket (sold separately). Connector is included with corner modules
- Operating Temperature: -13°F~104°F
- Adjustable Suspension Brackets Provided on Top of The Fixtures
- 5-Year Warranty

Lighting:

- Dimmable: 0~10V Dimming
- Total Lumens: 1650LM
- Color Temperatures: 2700K/3000K/3500K/4000K/5000K
- Multi-CCT(Selectable with Switch Inside the Fixture)
- Color Rendering Index: CRI ≥ 80
- Integrated uplight module with selectable uplight proportions
- 50,000 Hours Rated Life
- Beam Angle: 104.8°(H) x 100.5°(V)

Applications:

- Ideal for offices, hotels, corridors, saloons, libraries, meeting rooms, conference halls, and the best solution for modern lighting solutions
- It can be used in any indoor applications



Phone: (877) 805-2252 | Fax: (877) 805-2252
www.westgatemfg.com |



WG-Z5-ZB-2Z

Photometrics: SCX1.5-2FT-UD-MCTP5-D

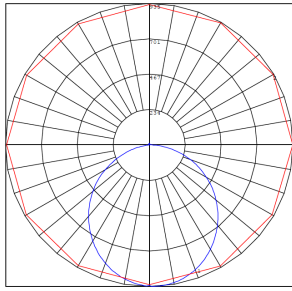
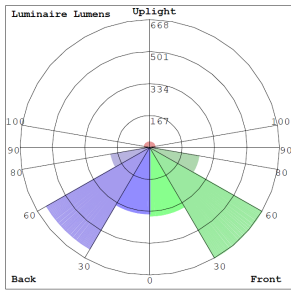

BUD Rating: B1-U2-G1

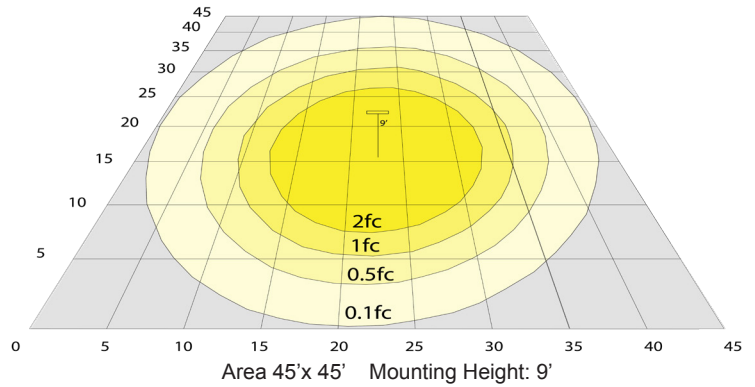

Other Views:



Side View

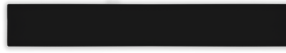

Front View

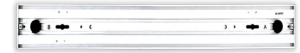

Back View

Performance Table: SCX1.5-2FT-UD-MCTP5-D

MODEL NO.	Wattage	Voltage	Lumens	Color Temp.	BUG Rating	LPW
SCX1.5-2FT-UD-MCTP5-D	8W 11W 13W 15W	120~277V	880LM 1210LM 1430LM 1650LM	2700K 3000K 3500K 4000K 5000K	B1-U2-G1	110

Sample Ordering

Model	Size	Up/Down	Color Temp.	Feature
SCX1.5	2FT	UD	MCTP5	D

Accessories:

- Blank** = No Option For Accessories
SCL-CS1-6FT = ADJ. 6FT 1/16in SINGLE SUSPENSION CANOPY SET WITH KEYHOLE END CONNECTOR, NON-POWER SIDE
SCL-CS1P-6FT = ADJ. 6FT 1/16in SINGLE SUSPENSION CANOPY SET WITH KEYHOLE END CONNECTOR, POWER SIDE WITH SJTW18/5 WHITE CORD
SCL-CS1P-6FT-NC = ADJ. 6FT 1/16in SINGLE SUSPENSION CANOPY SET WITH KEYHOLE END CONNECTOR
SCL-CSK-6FT = ADJ. 6FT 1/16in SUSPENSION CANOPY COMPLETE KIT FOR BOTH SIDES WITH KEYHOLE END CONNECTORS
SCL-GS10 = ADJ. 10FT 1/16in DOUBLE SUSPENSION CABLE WITH SINGLE KEYHOLE CONN., LOOP GRIPPER ON TOP
SCL-GS20 = ADJ. 20FT 1/16in DOUBLE SUSPENSION CABLE WITH SINGLE KEYHOLE CONN., LOOP GRIPPER ON TOP
SCL-6FT-SJTW18/5 = 6FT WHITE CORD, SJTW 18 AWG 5-CONDUCTOR (BLACK, WHITE, GREEN + PURPLE & GRAY FOR 0-10V DIMMING)
SCL-6FT-SJTW18/5-100FT = 100FT ROLL OF WHITE CORD, SJTW 18 AWG 5-CONDUCTOR (BLACK, WHITE, GREEN + PURPLE & GRAY FOR 0-10V DIMMING)
SCL-6FT-SJTW18/5-100FT-BK = 100FT ROLL OF BLACK CORD, SJTW 18 AWG 5-CONDUCTOR (BLACK, WHITE, GREEN + PURPLE & GRAY FOR 0-10V DIMMING)
SCL-6FT-SJTW18/6-100FT = 100FT ROLL OF BLACK CORD, SJTW 18 AWG 6-CONDUCTOR (BLACK, WHITE, GREEN + PURPLE & GRAY FOR 0-10V DIMMING + RED FOR BACKUP INVERTOR)
SCL-AH = Heavy-Duty Auxiliary Hook for Up To 1/16" Aircraft Cable
SCL-ASC-500FT = 1/16" 500 ft. Steel Aircraft Cable Suspension
SCX1.5-CONKIT = INTERNAL CONNECTION BRACKET REQUIRED FOR SEAMLESS CONNECTION (SOLD SEPARATELY)

Factory-Installed Options:

- Blank** = No Option For Accessories
OPT-HBC-125BS-WH = 10FT, 15A, 125V, 18/3 STR, WHT

SUSPENDED MOUNTING ACCESSORIES (NOT INCLUDED)



FACTORY-INSTALLED OPTIONS:



OPT-HBC-125BS-WH



MOUNTING AND MODULES OPTIONS:



*Seamless connection shown requires SCX1.5-CONKIT internal connection bracket (sold separately)

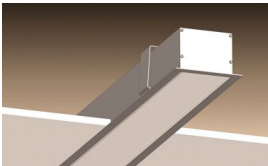

Recessed Mounted (Flanged)

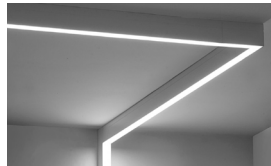

Surface Mounted



Wall Mounted



Suspended



T-Bar Installation

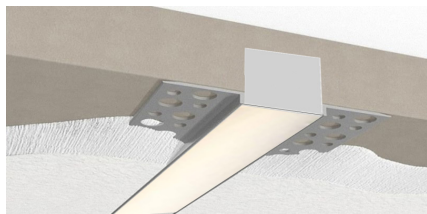

Flangless Recessed Mounted (Mud-In)



Louver Kit Option

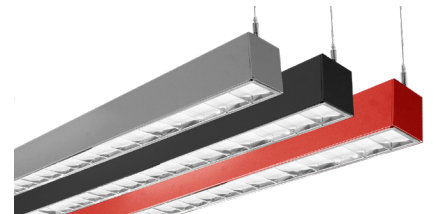

Color of Your Choice

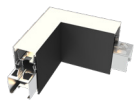

L Module

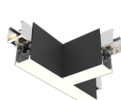

T Module

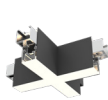

X Module



Inside Corner Module

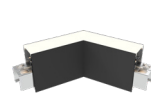

120° Corner Module



Y Module



C60 Module

SCX1.5-L-UD-MCT5-BK SCX1.5-T-UD-MCT5-BK SCX1.5-X-UD-MCT5-BK SCX1.5-IC-UD-MCT5-BK SCX1.5-C120-UD-MCT5-BK SCX1.5-Y-UD-MCT5-BK SCX1.5-C60-UD-MCT5-BK



OC Module

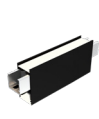

6in Module

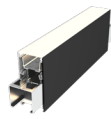

9in Module

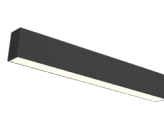

1FT Module

SCX1.5-OC-UD-MCTS-BK SCX1.5-GIN-UD-MCTS-BK SCX1.5-9IN-UD-MCT5-BK SCX1.5-1FT-UD-MCTP5-D-BK



MOUNTING OPTIONS:

FLANGLESS RECESSED INSTALLATION IN WOOD CEILING

No additional accessories required.

Make recessed preparations by installing a horizontal plank of wood on top of the wood ceiling at a recessed height of 3 3/8".

Screw and anchor kit provided with each fixture can be used to fasten the top of the fixture to the wood plank through the holes on top of the fixture.

You can also install vertical wood boards on top of the ceiling at the edge of the opening and open the fixture and put screws through the side of the fixture housing to fasten it to the wood boards.



*Seamless connection shown requires SCX1.5-CONKIT internal connection bracket (sold separately)

SUSPENSION ROD KITS (SET OF 2)

Model	SIZE
SCL-RS-12	12 IN
SCL-RS-18	18 IN
SCL-RS-24	24 IN
SCL-RS-36	36 IN
SCL-RS-48	48 IN

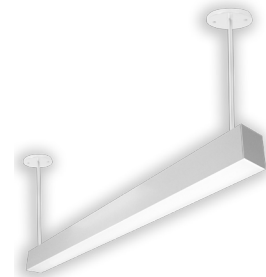

WALL MOUNTING

Model	DESCRIPTION
OPT-SCX1.5-WM-2FT	Install this optional wall mounting brackets on the back of the fixture. Connection cables will enter the fixture through one of these wall-mounting brackets. On your purchase order, please specify the position of where your wire entry from the wall.

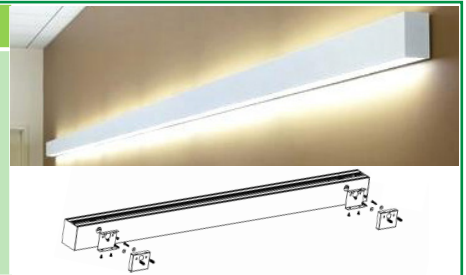

WALL MOUNTING

Model	DESCRIPTION
OPT-SCX1.5-WMA-2FT	Add this option to the fixture, and wall mounting arms with a wall canopy will be installed on the back of the fixture. The length of each arm is 5". Connection cables will enter the fixture through one of the arms. On your purchase order, specify the position of your wire entry from the wall, and the arm will be installed on the back accordingly.



RECESSED MOUNT WITH FLANGE

Model	DESCRIPTION
OPT-SCX1.5-FMR-2FT	Order this option and the fixture will be equipped with a 1/2" wide flange on four sides. Advanced design toggle-style brackets will also be provided, to adjust and hold the fixture against drywall or other hard ceilings from the top. When linking to another fixture or corner module, call us or send a copy of your plan along with your PO, and flanges will be removed on those ends that need to make a seamless connection. *Seamless connection shown requires SCX1.5-CONKIT internal connection bracket (sold separately)

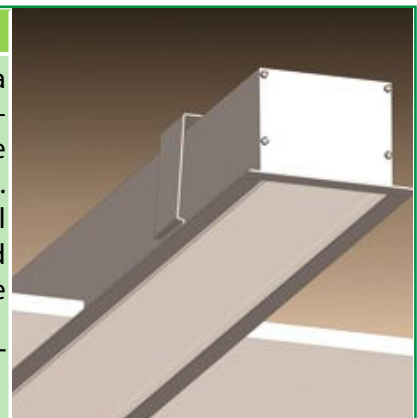

FLANGELESS RECESS MOUNT IN DRYWALL (MUD-IN)

Model	DESCRIPTION
OPT-SCX1.5-MIF-2FT	Order this option and the fixture will be equipped with mud-in brackets on all four sides, mounted at 1/16" from the lens surface (specify if other spacing is needed). Advanced design toggle-style brackets will also be provided, to adjust and hold the fixture against the drywall ceiling from the top. When linking to another fixture or corner fixture module call us or send a copy of your plan along with your PO and flanges will be removed on those end that needs to make a seamless connection.
OPT-SCX1.5-MIF-L	This is a L Module option.
OPT-SCX1.5-MIF-T	This is a T Module option.
OPT-SCX1.5-MIF-X	This is a X Module option.
OPT-SCX1.5-MIF-IC	This is a Inside Corner Module option.

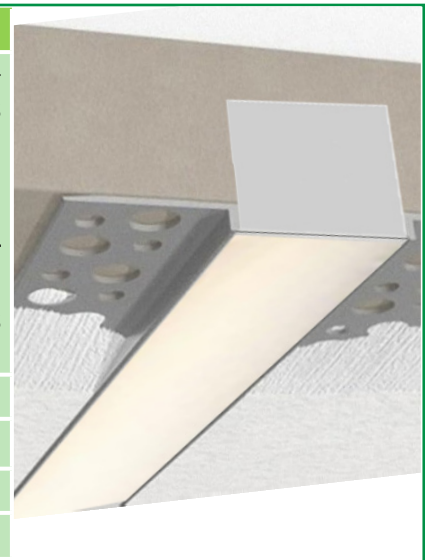

T-BAR INSTALLATION

Model	DESCRIPTION
OPT-SCX1.5-TBAR-2FT	Add this option and 1/2" wide flanges will be installed on the two long sides of the fixture. The two ends of the fixture will fall onto the T-bar grids and will be supported this way. The T-bar tiles on the two sides of the fixture must be cut to allow for the width of the fixture. The tile will fall onto and be supported by the flanges on both sides of the fixture. If you plan to support the fixture by the grids on three sides and tile on one side, call us or specify on your PO, and flange will be installed only on one side of the fixture. To provide safety and support from the beams above the T-bar ceiling order 10ft or 20ft aircraft suspension kits below.
SCL-GS10	Adjustable 1/16" 10ft suspension kit with loop gripper & toggle ends hold up to 70 lbs load.
SCL-GS20	Adjustable 1/16" 20ft suspension kit with loop gripper & toggle ends hold up to 70 lbs load.
OPT-FWH-63	This is a 6FT 3-Wire Whip option.
OPT-FWH-65	This is a 6FT 5-Wire Whip option.
OPT-FWH-66	This is a 6FT 6-Wire Whip option.



*Seamless connection shown requires SCX1.5-CONKIT internal connection bracket (sold separately)

SURFACE MOUNTING

No additional accessories required. Screw and anchor kit provided with each fixture can be used to fasten the fixture directly to the hard surface through the holes on top of the fixture.

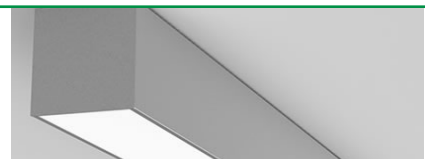

SCX1.5-CONKIT

SCX1.5-CONKIT internal connection bracket required for seamless connection (sold separately)



FIELD-INSTALLED FLANGED RECESSED MOUNT DRYWALL KIT

Model	DESCRIPTION	SIZE
SCX1.5-FMRK-2FT	SCX-2Ft. Field-Installed Flanged Recessed Mount Drywall Kit	2FT



SCX1.5 FIELD-INSTALLED MUD-IN FLANGE-LESS RECESSED MOUNT KIT

Model	DESCRIPTION	SIZE
SCX1.5-MIFK-2FT	SCX-2Ft Field-Installed Mud-In Flange-Less Recessed Mount Kit	2FT

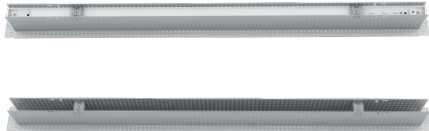

FACTORY-INSTALLED OPTIONS:

EMERGENCY BATTERY BACKUP

Model	DESCRIPTION
OPT-EM-CM1INT	This is an option for a 90-minute backup battery installation. If you need to order this series for the fixture, please have your purchase order ready and call us or specify on the order which fixture to install this option and the test button.

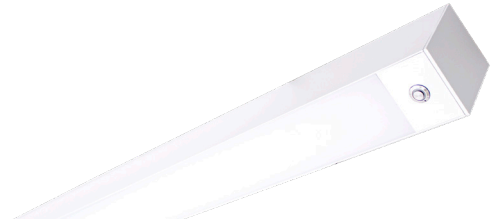

BI-LEVEL MOTION SENSOR

Model	DESCRIPTION
OPT-SCX-SEN2US	This option installs an advanced motion sensor that will turn the lights on when the area is occupied. When the area is cleared, after a preset hold time of 5 sec or more the lights are dimmed to a standby level of 30% or more. If still no motion is detected, after the standby period, the light is turned off. All setting is programmable with a remote control.
OPT-WEC-3RC	This is an optional remote control for sensor.
OPT-SEN-SCX-2MRLV-5	This is a programmable microwave Bi-Level sensor.
OPT-SEN-2US-DAYLIGHT	It is an ultrasonic Bi-Level Dimming Daylight sensor option for internal installation inside the fixture. (Remote not needed)

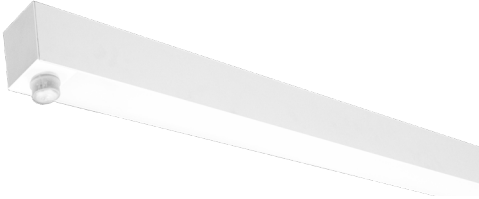

COLOR OF YOUR CHOICE

Model	DESCRIPTION
OPT-SCX-CLR-2FT	Add this option and specify your desired color on your purchase order or provide a swatch to match. For painted flanged fixture or optional rod, mounting set please also add the relevant option below for each fixture.
OPT-SCX-CLR-FRM	This is a painted flanges option
OPT-SCX-CLR-RODSET	This is a painted rod set option.

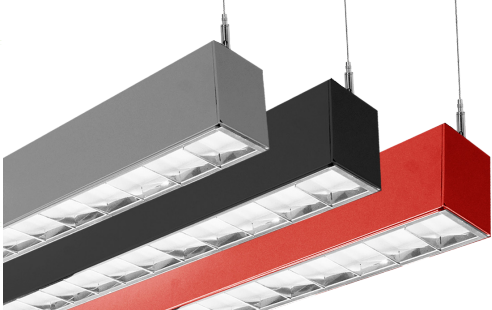

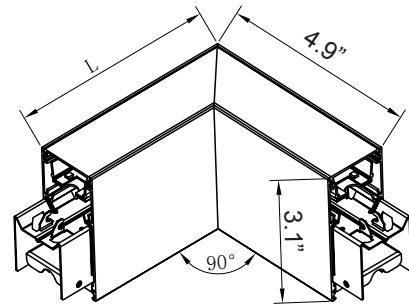
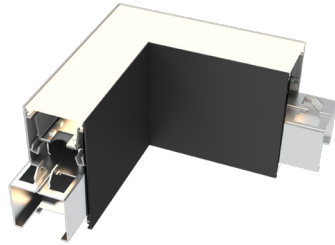

CORNER FIXTURE MODULES:

Built-in LED Modules

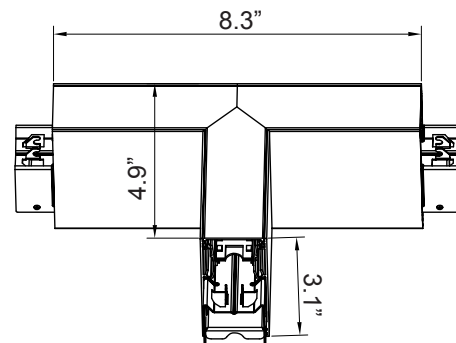
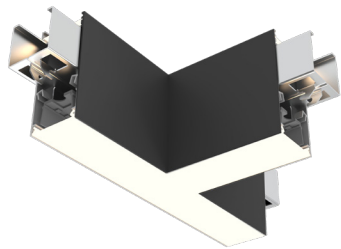

Model	JOINT TYPE	LUMENS	MCT4	DIMENSION
SCX1.5-L-UD-MCT5-BK	L	508LM 575LM 616LM 660LM	2700K 3000K 3500K 4000K 5000K	4.9" X 4.9" X 3.1"



Model	JOINT TYPE	LUMENS	COLOR TEMP	DIMENSION
SCX1.5-T-UD-MCT5-BK	T	629LM 726LM 787LM 854LM	2700kK 3000K 3500K 4000K 5000K	8.3" X 4.9" X 3.1"

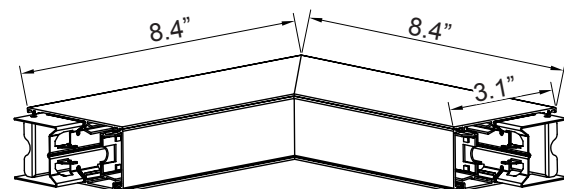

Model	JOINT TYPE	LUMENS	COLOR TEMP	DIMENSION
SCX1.5-IC-UD-MCT5-BK	INSIDE CORNER	629LM 726LM 787LM 854LM	2700K 3000K 3500K 4000K 5000K	8.4" X 8.4" X 3.1"



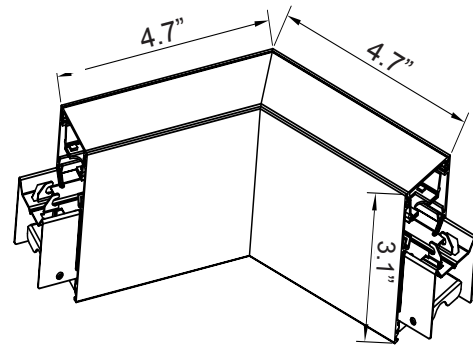
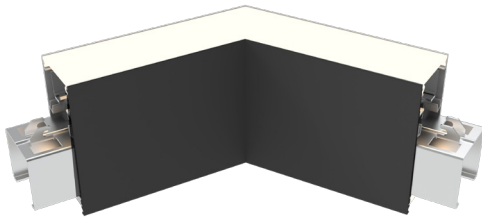

Model	JOINT TYPE	LUMENS	COLOR TEMP	DIMENSION
SCX1.5-C120-UD-MCT5-BK	120° CORNER	508LM 575LM 616LM 660LM	2700K 3000K 3500K 4000K 5000K	4.7" X 4.7" X 3.1"

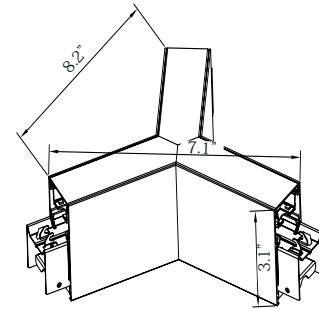
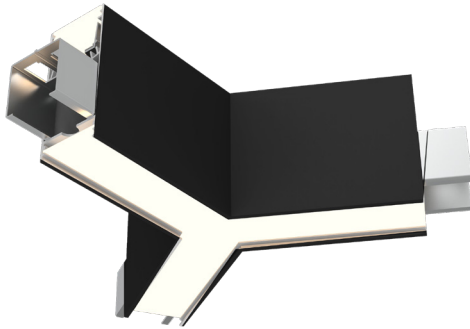

Model	JOINT TYPE	LUMENS	COLOR TEMP	DIMENSION
SCX1.5-Y-UD-MCT5-BK	Y	508LM 575LM 616LM 660LM	2700K 3000K 3500K 4000K 5000K	8.2" X 7.1" X 3.1"



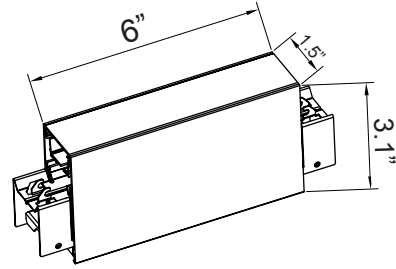
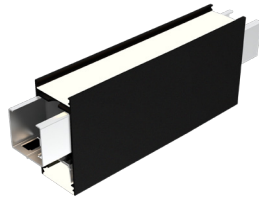

Model	JOINT TYPE	LUMENS	COLOR TEMP	DIMENSION
SCX1.5-6IN-UD-MCTS-BK	6in Module	508LM 575LM 616LM 660LM	2700K 3000K 3500K 4000K 5000K	6" X 3.1" X 1.5"

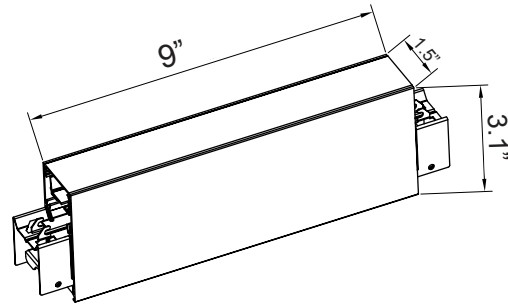
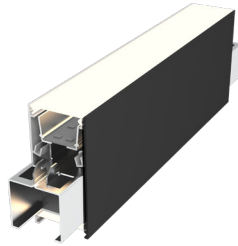

Model	JOINT TYPE	LUMENS	COLOR TEMP	DIMENSION
SCX1.5-9IN- UD-MCT5-BK	9in Module	508LM 575LM 616LM 660LM	2700K 3000K 3500K 4000K 5000K	9" X 1.5" X 3.1"

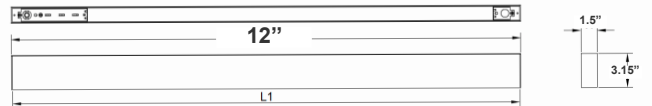
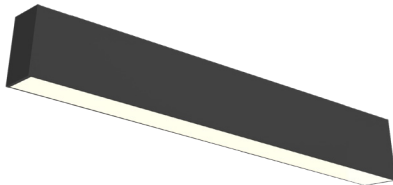

Model	JOINT TYPE	LUMENS	COLOR TEMP	DIMENSION
SCX1.5-1FT- UD-MCTP5-BK	1FT Module	508LM 575LM 616LM 660LM	2700K 3000K 3500K 4000K 5000K	12" X 1.5" X 3.1"



COLOR CHART: * Choose from one of our Premium Colors with no set-up fee.

Gloss:



Hammer:



Texture:



Vein:

