

# SCX SERIES

Commercial Lighting

**WESTGATE**  
THE FUTURE IS HERE...AND IT'S QUITE BRIGHT!

SCX-Y2FT-60W-MCT4-D

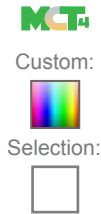
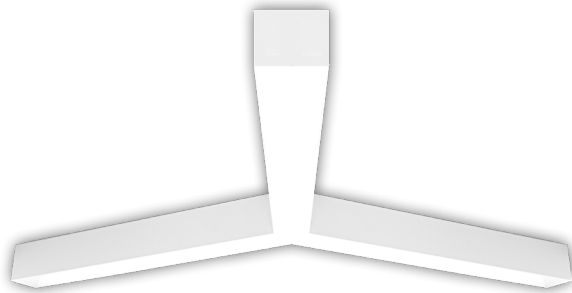

Customer Name: \_\_\_\_\_

Project Name: \_\_\_\_\_

Note: \_\_\_\_\_

Type: \_\_\_\_\_

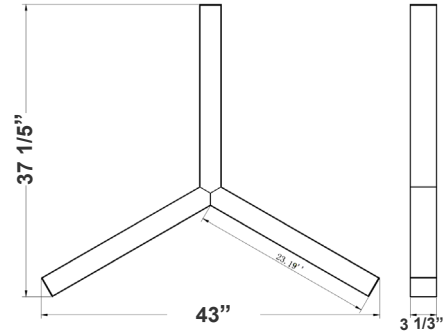

37 1/5"(L) x 43"(W) x 3 1/3"(H)

The SCX series offers the best and the most comprehensive selection for linear lighting. The various available lengths and widths allow the creation of the desired shape to elevate the areas aesthetics to a unique and modern look while providing an impressive illumination for the occupants. Ideal for, retail locations, offices, lobbies, conference rooms, reception areas, hallways, educational facilities, hotels, and restaurants. FEATURES: Superior Architectural Look Energy-efficient: Low Wattage Consumption & High Lumen Output Easier Wire Management & Install Variety of Mounting Options Multi Color Temperature (Selectable Switch Inside Fixture) Variety Of Factory Customizations Available

## Features

- LED Superior Architectural Lights
- Seamless Linkable Linear Lighting System
- Opal Polycarbonate Lens-Direct (DOWN) Lighting
- Optional Recessed Option Available
- Optional Louver Version Lens Available
- Lens Type: Opal Polycarbonate Lens
- MCT: Multi Color Temperature (Selectable Switch Inside Fixture)

## Technical Specifications

### Electrical:

- Voltage: 120-277VAC 50/60Hz
- Wattage: 60W
- Power Factor: >0.95
- Total Harmonic Distortion:  $\leq 20\%$

### Mechanical:

- Low Profile Modern Design
- Aluminum Housing With Matte White Finish
- Custom Colors Available
- Lens Snaps into Housing
- Make Different Connections Via T/L/X Joints on Both Ends
- Mounting Options: Surface, Suspended, Recessed
- IP Rating: IP54
- Operating Temperature:  $-13^{\circ}\text{F} \sim 104^{\circ}\text{F}$
- Adjustable Suspension Brackets Provided on Top of The Fixtures

### Lighting:

- Dimmable: 0~10V Dimming
- Total Lumens: 7102LM
- Color Temperatures: 3000K/3500K/4000K/5000K
- Multi-CCT(Selectable Switch Inside Fixture)
- Color Rendering Index: CRI  $\geq 80$
- Up Light Option Available
- 50,000 Hours Rated Life
- 5-Year Warranty
- Beam Angle:  $104.8^{\circ}(\text{H}) \times 100.5^{\circ}(\text{V})$

### Applications:

- Ideal for offices, hotels, corridors, saloons, libraries, meeting rooms, conference halls, and the best solution for modern lighting solutions
- It can be used in any indoor applications



Phone: (877) 805-2252 | Fax: (877) 805-2252  
www.westgatemfg.com |



WG-ZA-26-2Z

## Photometrics: SCX-Y2FT-60W-MCT4-D

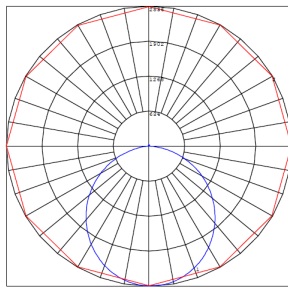
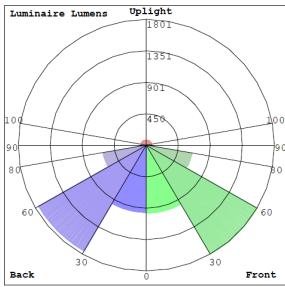

BUD Rating: B2-U3-G1

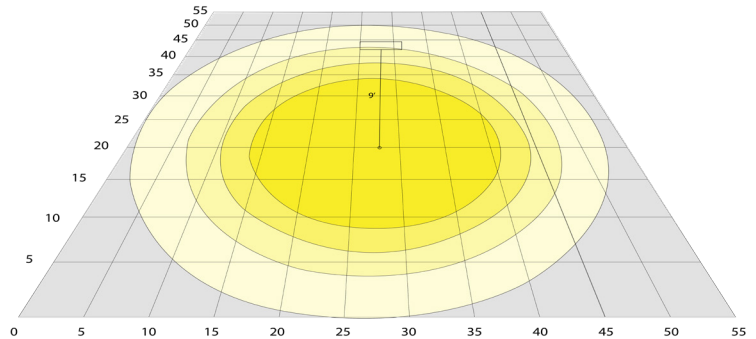

Area 55'x 55' Mounting Height: 9'

## Other Views:



Side View

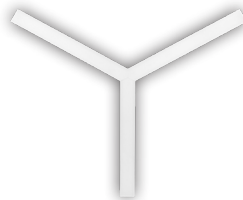

Front View



Back View

## Performance Table: SCX-Y2FT-60W-MCT4-D

MODEL NO.	Wattage	Voltage	Lumens	Color Temp.	BUG Rating	LPW
SCX-Y2FT-60W-MCT4-D	60W	120~277V	7102LM	3000K 3500K 4000K 5000K	B2-U3-G1	118

## Sample Ordering

Model Size Wattage Color Temp. Feature

SCX - Y2FT - 60W - MCT4 - D

## Accessories:

Blank = No Option For Accessories

SCL-3CS10 = Adjustable 10ft 1/16" Aircraft Cable Suspension Kit with 8-11/16" Diameter Canopy (1-5/8" H)

SCL-6FT-SJTW18/5 = 6ft White Cord, SJTW 18 AWG 5-Conductor (Black, White, Green + Purple & Gray for 0-10V Dimming)

SCL-6FT-SJTW18/5-100FT = 100ft Roll of White Cord, SJTW 18 AWG 5-Conductor (Black, White, Green + Purple & Gray for 0-10V Dimming)

SCL-6FT-SJTW18/5-100FT-BK = 100ft Roll of Black Cord, SJTW 18 AWG 5-Conductor (Black, White, Green + Purple & Gray for 0-10V Dimming)

SCL-6FT-SJTW18/6-100FT = 100ft Roll of Black Cord, SJTW 18 AWG 6-Conductor (Black, White, Green + Purple & Gray for 0-10V Dimming + Red for Backup Inverter)

SCL-AH = Heavy-Duty Auxiliary Hook for Up To 1/16" Aircraft Cable

SCL-ASC-500FT = 1/16" 500 ft. Steel Aircraft Cable Suspension

\* More Mounting Options Refer to page 4

## Factory-Installed Options:

Blank = No Option For Accessories

OPT-HBC-125BS-WH = 10FT, 15A, 125V, 18/3 STR, WHT

\* More Factory-Installed Options Refer to page 6

## Example:

1. SCX-Y2FT-60W-MCT4-D (For SCX 60W MCT4 fixture 120-277V)
2. SCX-Y2FT-60W-MCT4-D OPT-HBC-125BS-WH (For SCX 60W MCT4 fixture 120-277V) (10FT, 15A, 125V, 18/3 STR, WHT)

## SUSPENDED MOUNTING ACCESSORIES (NOT INCLUDED)



SCL-3CS10 (Canopy can be painted)



SCL-6FT-SJTW18/5-100FT  
SCL-6FT-SJTW18/6-100FT



SCL-6FT-SJTW18/5-100FT-BK



SCL-ASC-500FT



SCL-AH



SCL-ASC-500FT



SCL-6FT-SJTW18/5

## FACTORY-INSTALLED OPTIONS:



OPT-HBC-125BS-WH



## MOUNTING AND MODULES OPTIONS:

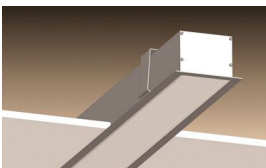

Recessed Mounted  
(Flanged)



Surface Mounted



Suspended

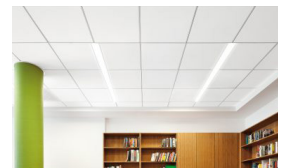

T-Bar Installation

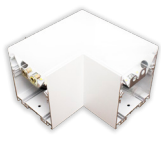

L Module  
(page 7)

SCX-L-MCT4



T Module  
(page 7)

SCX-T-MCT4



X Module  
(page 7)

SCX-X-MCT4



Inside Corner Module  
(page 7)

SCX-IC-MCT4

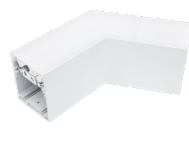

120° Corner Module  
(page 8)

SCX-C120-MCT4



Y Module  
(page 9)

SCX-Y-MCT4



L1FT Corner Module  
(page 9)

SCX-L1FT-MCT4



6in Module  
(page 9)

SCX-6IN-MCT4



9in Module  
(page 9)

SCX-9IN-MCT4

### LIGHTS SCX FLEXIBLE LENS ROLL 25FT OR 100FT

Model	SIZE	DESCRIPTION
SCX-FLEXLENS-25FT	25FT	Flex lenses can be cut to different lengths, enabling precise customization according to the installation area. This allows for a seamless fit, reducing gaps or visible transitions between different sections of the SCX lights
SCX-FLEXLENS-100FT	100FT	



## MOUNTING OPTIONS:

### FLANGLESS RECESSED INSTALLATION IN WOOD CEILING

No additional accessories required.  
 Make recessed preparations by installing a horizontal plank of wood on top of the wood ceiling at a recessed height of 3 3/8".  
 Screw and anchor kit provided with each fixture can be used to fasten the top of the fixture to the wood plank through the holes on top of the fixture.  
 You can also install vertical wood boards on top of the ceiling at the edge of the opening and open the fixture and put screws through the side of the fixture housing to fasten it to the wood boards.

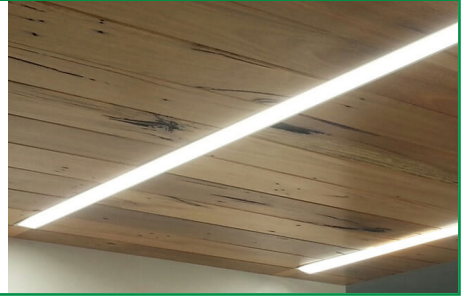

### SUSPENSION ROD KITS (SET OF 2)

Model	SIZE
SCL-RS-12	12 IN
SCL-RS-18	18 IN
SCL-RS-24	24 IN
SCL-RS-36	36 IN
SCL-RS-48	48 IN

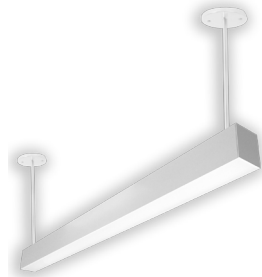

### RECESSED MOUNT WITH FLANGE

Model	DESCRIPTION
OPT-SCX-FMR-Y2FT	Order this option and the fixture will be equipped with a 1/2" wide flange on four sides. Advanced design toggle-style brackets will also be provided, to adjust and hold the fixture against drywall or other hard ceilings from the top. When linking to another fixture or corner module, call us or send a copy of your plan along with your PO, and flanges will be removed on those ends that need to make a seamless connection.

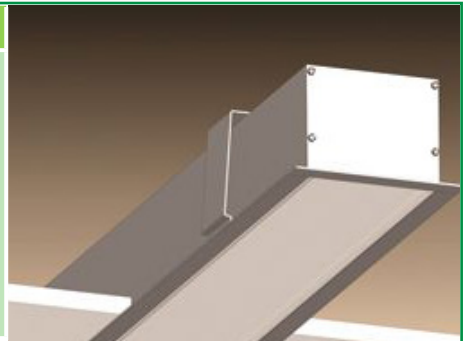

### LINKING

Model	DESCRIPTION
OPT-SCX-LINKWIRING	Fixtures are equipped with pre-installed linking brackets and accessories and only need to be wired together. To receive a fixture prewired for linking, order the option below for each link to another fixture or a corner module.

### FLANGELESS RECESS MOUNT IN DRYWALL (MUD-IN)

Model	DESCRIPTION
OPT-SCX-MIF-Y2FT	Order this option and the fixture will be equipped with mud-in brackets on all four sides, mounted at 1/16" from the lens surface (specify if other spacing is needed). Advanced design toggle-style brackets will also be provided, to adjust and hold the fixture against the drywall ceiling from the top. When linking to another fixture or corner fixture module call us or send a copy of your plan along with your PO and flanges will be removed on those end that needs to make a seamless connection.
OPT-SCX-MIF-L	This is a L Module option.
OPT-SCX-MIF-T	This is a T Module option.
OPT-SCX-MIF-X	This is a X Module option.
OPT-SCX-MIF-IC	This is a Inside Corner Module option.

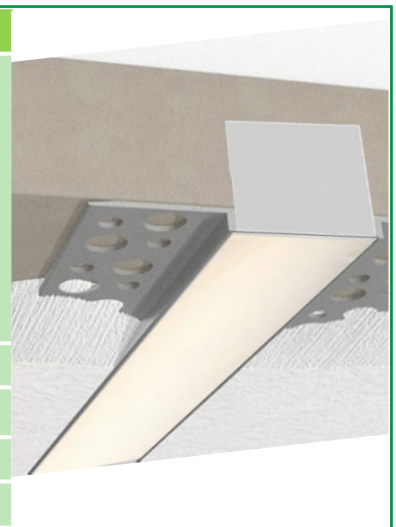

## SURFACE MOUNTING

No additional accessories required.  
Screw and anchor kit provided with each fixture can be used to fasten the fixture directly to the hard surface through the holes on top of the fixture.

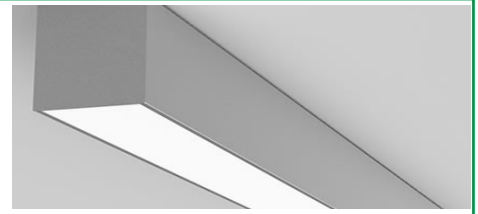

## FACTORY-INSTALLED OPTIONS:

### COLOR OF YOUR CHOICE

Model	DESCRIPTION
OPT-SCX-CLR-Y2FT	Add this option and specify your desired color on your purchase order or provide a swatch to match. For painted flanged fixture or optional rod, mounting set please also add the relevant option below for each fixture.
OPT-SCX-CLR-FRM	This is a painted flanges option.
OPT-SCX-CLR-RODSET	This is a painted rod set option.

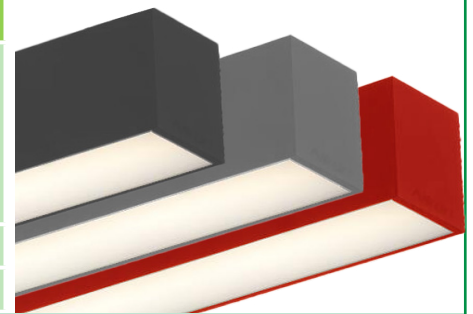

### INDIRECT (UP) LIGHTING

Model	WATTS	LUMENS	COLOR TEMP	SIZE
OPT-SCX-ULM-Y2FT-24W-MCT4	24W	2400LM 2472LM 2520LM 2592LM	3000K 3500K 4000K 5000K	3 X 2FT
OPT-SCX-ULM-BU	Indirect (up) light with blue color			
OPT-SCX-ULM-GR	Indirect (up) light with green color			

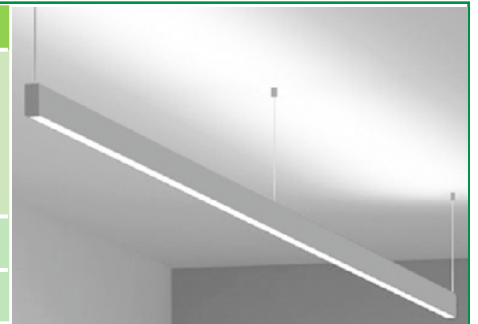

### EMERGENCY BATTERY BACKUP

Model	DESCRIPTION
OPT-EM-CM1INT	This is an option for a 90-minute backup battery installation. If you need to order this series for the fixture, please have your purchase order ready and call us or specify on the order which fixture to install this option and the test button.

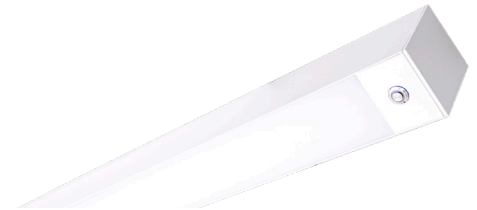

### BI-LEVEL MOTION SENSOR

Model	DESCRIPTION
OPT-SCX-SEN2US	This option installs an advanced motion sensor that will turn the lights on when the area is occupied. When the area is cleared, after a preset hold time of 5 sec or more the lights are dimmed to a standby level of 30% or more. If still no motion is detected, after the standby period, the light is turned off. All setting is programmable with a remote control.
OPT-WEC-3RC	This is an optional remote control for sensor.
OPT-SEN-SCX-2MRLV-5	This is a programmable microwave Bi-Level sensor.
OPT-SEN-2US-DAYLIGHT	It is an ultrasonic Bi-Level Dimming Daylight sensor option for internal installation inside the fixture. (Remote not needed)

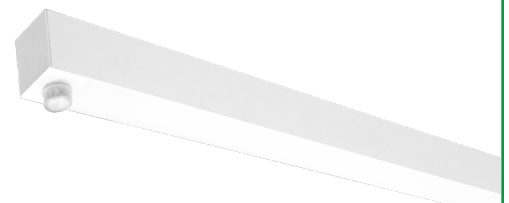

## CORNER FIXTURE MODULES:

### Built-in LED Modules

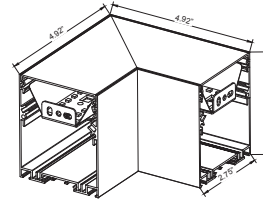
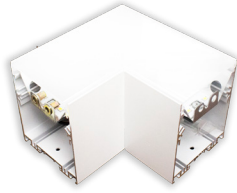

Model	JOINT TYPE	LUMENS	MCT4	DIMENSION
SCX-L-MCT4	L	508LM 575LM 616LM 660LM	3000K 3500K 4000K 5000K	4.92" X 4.92" X 3.35" X 2.75"

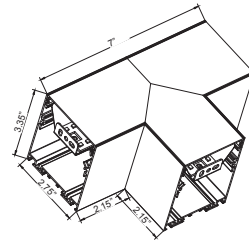

Model	JOINT TYPE	LUMENS	COLOR TEMP	DIMENSION
SCX-T-MCT4	T	629LM 726LM 787LM 854LM	3000K 3500K 4000K 5000K	7" X 3.35" X 2.75" X 2.15" X 2.15"

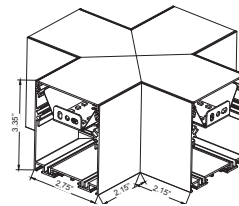
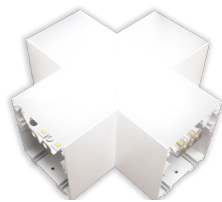

Model	JOINT TYPE	LUMENS	COLOR TEMP	DIMENSION
SCX-X-MCT4	X	733LM 863LM 944LM 1037LM	3000K 3500K 4000K 5000K	3.35" X 2.75" X 2.15" X 2.15"

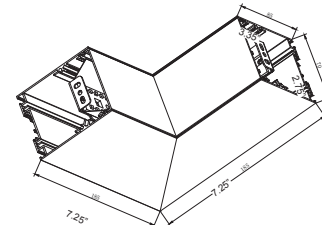

Model	JOINT TYPE	LUMENS	COLOR TEMP	DIMENSION
SCX-IC-MCT4	INSIDE CORNER	629LM 726LM 787LM 854LM	3000K 3500K 4000K 5000K	7.25" X 7.25" X 3.35" X 2.75"



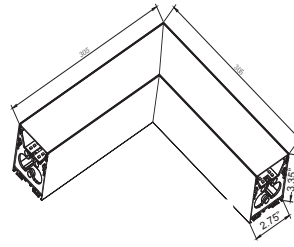
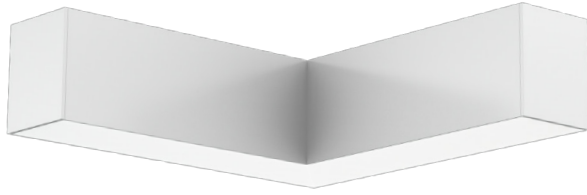

Model	JOINT TYPE	LUMENS	COLOR TEMP	DIMENSION
SCX-L1FT-MCT4	L FIXTURE	2197LM 2316LM 2348LM 2390LM	3000K 3500K 4000K 5000K	12" X 12" X 3.35" X 2.75"

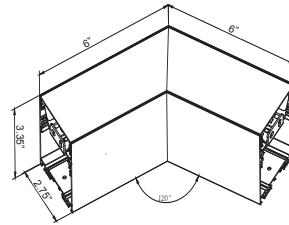

Model	JOINT TYPE	LUMENS	COLOR TEMP	DIMENSION
SCX-C120-MCT4	120° CORNER	508LM 575LM 616LM 660LM	3000K 3500K 4000K 5000K	6" X 6" X 3.35" X 2.75"

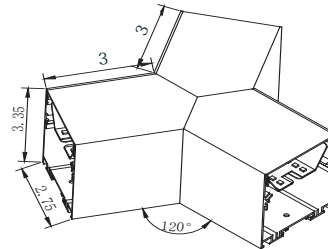
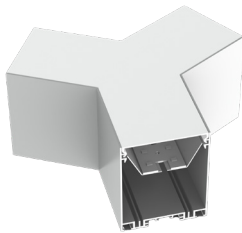

Model	JOINT TYPE	LUMENS	COLOR TEMP	DIMENSION
SCX-Y-MCT4	Y	508LM 575LM 616LM 660LM	3000K 3500K 4000K 5000K	3" X 3" X 3.35" X 2.75"



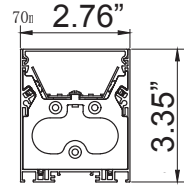
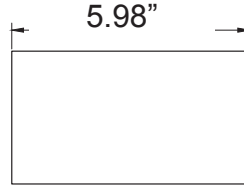
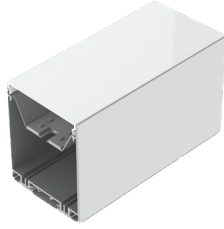

Model	JOINT TYPE	LUMENS	COLOR TEMP	DIMENSION
SCX-6IN-MCT4	6in Module	508LM 575LM 616LM 660LM	3000K 3500K 4000K 5000K	5.98" X 2.76" X 3.35"

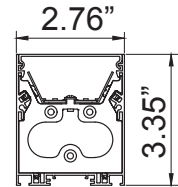
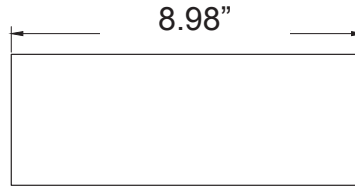
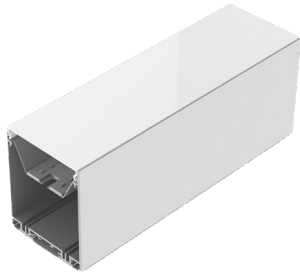

Model	JOINT TYPE	LUMENS	COLOR TEMP	DIMENSION
SCX-9IN-MCT4	9in Module	508LM 575LM 616LM 660LM	3000K 3500K 4000K 5000K	8.98" X 2.76" X 3.35"





**COLOR CHART:** \* Choose from one of our Premium Colors with no set-up fee.

**Gloss:**



SILVER METALLIC  
70 GLOSS  
T357-GR105



SILVER METALLIC  
30 GLOSS  
T353-GR06



DARK RED 90  
GLOSS  
P009-RD02



INTERNATIONAL  
ORANGE 90  
GLOSS  
T009-OG26



SAFETY ORANGE  
90 GLOSS  
T009-OG01



YELLOW 90  
GLOSS  
T009-YL14



YELLOW 90  
GLOSS  
T009-YL01

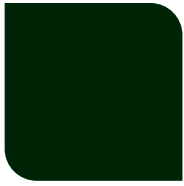

TRAFFIC GREEN  
70 GLOSS  
T007-GN16



GREEN 70 GLOSS  
T007-GN13



GREEN 60 GLOSS  
C006-GN03



BLUE 90 GLOSS  
T009-BL01



DARK BLUE 80  
GLOSS  
T008-BL20

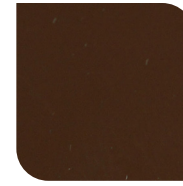

RAL 8028 TERRA  
BROWN 90 GLOSS  
C209-BR358

**Hammer:**



WHITE HAMMER  
T013-WH09



BEIGE HAMMER  
T013-BG38



GREY HAMMER  
C013-GR08

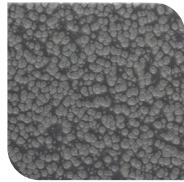

SILVER  
HAMMERTONE  
T064-GR05



BLACK HAMMER  
T013-BK62



RED HAMMER  
T013-RD15

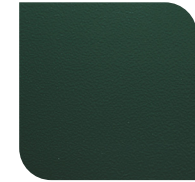

GREEN HAMMER  
T013-GN220

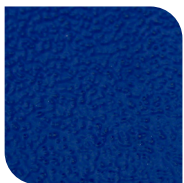

BLUE HAMMER  
T013-BL468



BRONZE HAMMER  
T012-BR161

**Texture:**



WHITE TEXTURE  
C031-WH120



FLINT GRAY  
TEXTURE  
T243-GR522



BLACK TEXTURE  
C241-BK109



RED TEXTURE  
T241-RD129



BLUE TEXTURE  
C241-BL544

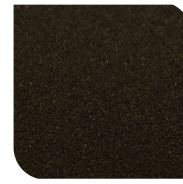

OIL RUBBED  
BRONZE TEXTURE  
T291-BR251

**Vein:**



BLACK/WHITE  
VEIN  
T075-WH34

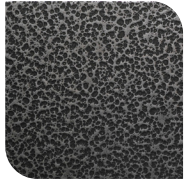

SILVER VEIN  
T375-BK26

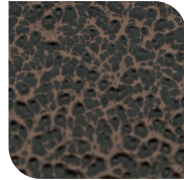

COPPER VEIN  
EXTERIOR  
T075-BK211



GOLD VEIN  
T375-BK10



COPPER VEIN  
T375-BK07

