

SCX SERIES

Commercial Lighting

WESTGATE
THE FUTURE IS HERE...AND IT'S QUITE BRIGHT!

SCX-L1FT-20W-MCT4-D

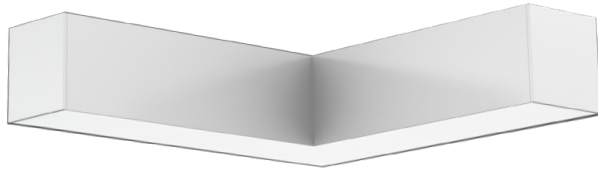

MCT

Custom:



Selection:



Customer Name: _____

Project Name: _____

Note: _____

Type: _____

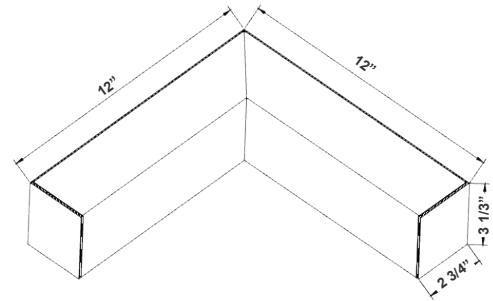

12" (L) x 3 1/8" (W) x 2 3/4" (H)

The SCX series offers the best and the most comprehensive selection for linear lighting. The various available lengths and widths allow the creation of the desired shape to elevate the areas aesthetics to a unique and modern look while providing an impressive illumination for the occupants. Ideal for, retail locations, offices, lobbies, conference rooms, reception areas, hallways, educational facilities, hotels, and restaurants. FEATURES: Superior Architectural Look Energy-efficient: Low Wattage Consumption & High Lumen Output Easier Wire Management & Install Variety of Mounting Options Multi Color Temperature (Selectable Switch Inside Fixture) Variety Of Factory Customizations Available

Features

- LED Superior Architectural Lights
- Seamless Linkable Linear Lighting System
- Opal Polycarbonate Lens-Direct (DOWN) Lighting
- Optional Recessed & Wall Mounting Kits Available
- Optional Louver Version Lens Available
- Lens Type: Opal Polycarbonate Lens
- MCT: Multi Color Temperature (Selectable with Switch Inside Fixture)

Technical Specifications

Electrical:

- Voltage: 120-277VAC 50/60Hz
- Wattage: 20W
- Power Factor: >0.95
- Total Harmonic Distortion: ≤ 20 %
- Efficacy: 110LPW

Mechanical:

- Low Profile Modern Design
- Aluminum Housing With Matte White Finish
- Custom Colors Available
- Lens Snaps into Housing
- Make Different Connections Via T/L/X Joints on Both Ends
- Mounting Options: Surface, Suspended (when connected to other SCX fixtures), Wall, Recessed
- IP Rating: IP54
- Operating Temperature: -13°F~104°F
- Adjustable Suspension Brackets Provided on Top of The Fixtures

Lighting:

- Dimmable: 0~10V Dimming
- Total Lumens: 2200LM
- Color Temperatures: 3000K/3500K/4000K/5000K
- Multi-CCT(Selectable with Switch Inside the Fixture)
- Color Rendering Index: CRI ≥ 80
- Up Light Option Available
- 50,000 Hours Rated Life
- 5-Year Warranty
- Beam Angle: 104.8°(H) x 100.5°(V)

Applications:

- Ideal for offices, hotels, corridors, saloons, libraries, meeting rooms, conference halls, and the best solution for modern lighting solutions
- It can be used in any indoor applications

Other Model:

- 40W | 4400LM | SCX-L2FT-40W-MCT4-D



Phone: (877) 805-2252 | Fax: (877) 805-2252
www.westgatemfg.com



WG-ZA-26-2Z

Photometrics: SCX-L1FT-20W-MCT4-D

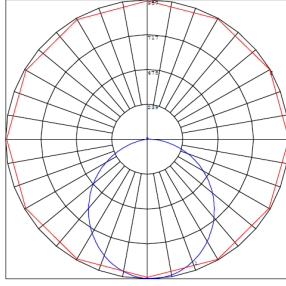
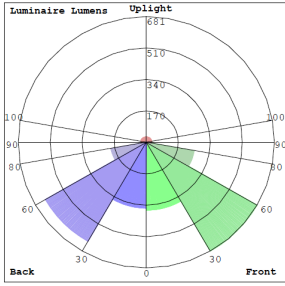

BUD Rating: B1-U2-G1

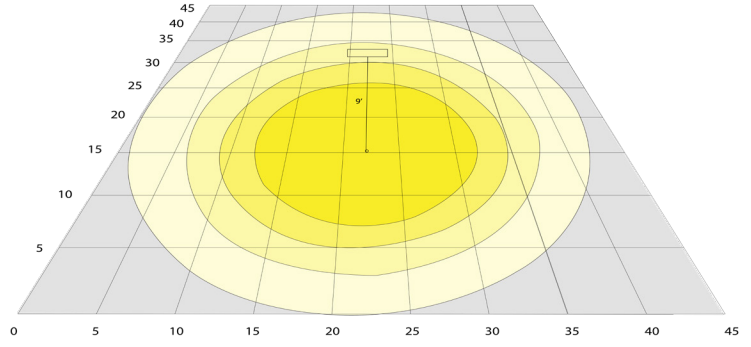

Area 45'x 45' Mounting Height: 9'

Other Views:



Side View

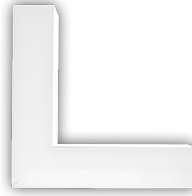

Front View



Back View

Performance Table: SCX-L1FT-20W-MCT4-D

| MODEL NO. | Wattage | Voltage | Lumens | Color Temp. | BUG Rating | LPW |
|---------------------|---------|----------|--------|----------------------------------|------------|-----|
| SCX-L1FT-20W-MCT4-D | 20W | 120~277V | 2200LM | 3000K 3500K 4000K 5000K | B1-U2-G1 | 110 |

Sample Ordering

Model **Size** **Wattage** **Color Temp.** **Feature**

SCX - L1FT - 20W - MCT4 - D

Accessories:

Blank = No Option For Accessories

SCL-6FT-SJTW18/5 = 6ft White Cord, SJTW 18 AWG 5-Conductor (Black, White, Green + Purple & Gray for 0-10V Dimming)

SCL-6FT-SJTW18/5-100FT = 100ft Roll of White Cord, SJTW 18 AWG 5-Conductor (Black, White, Green + Purple & Gray for 0-10V Dimming)

SCL-6FT-SJTW18/5-100FT-BK = 100ft Roll of Black Cord, SJTW 18 AWG 5-Conductor (Black, White, Green + Purple & Gray for 0-10V Dimming)

SCL-6FT-SJTW18/6-100FT = 100ft Roll of Black Cord, SJTW 18 AWG 6-Conductor (Black, White, Green + Purple & Gray for 0-10V Dimming + Red for Backup Inverter)

* More Mounting Options Refer to page 4

Factory-Installed Options:

Blank = No Option For Accessories

OPT-HBC-125BS-WH = 10FT, 15A, 125V, 18/3 STR, WHT

* More Factory-Installed Options Refer to page 6

ACCESSORIES:



SCL-6FT-SJTW18/5-100FT
SCL-6FT-SJTW18/6-100FT



SCL-6FT-SJTW18/5-100FT-BK



SCL-6FT-SJTW18/5

FACTORY-INSTALLED OPTIONS:



OPT-HBC-125BS-WH

Example:

1. SCX-L1FT-20W-MCT4-D

(For SCX 20W MCT4 fixture 120-277V)

2. SCX-L1FT-20W-MCT4-D

(For SCX 20W MCT4 fixture 120-277V)

OPT-HBC-125BS-WH

(10FT, 15A, 125V, 18/3 STR, WHT)



MOUNTING AND MODULES OPTIONS:

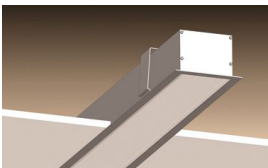

Recessed Mounted
(Flanged)



Surface Mounted



Wall Mounted

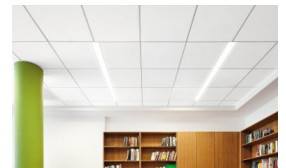

T-Bar Installation

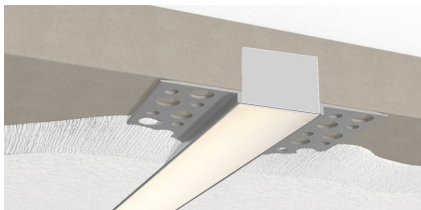

Flangless Recessed Mounted
(Mud-In)

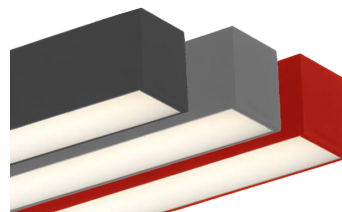

Color of Your Choice

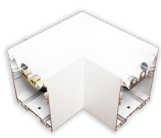

L Module
(page 7)

SCX-L-MCT4



T Module
(page 7)

SCX-T-MCT4

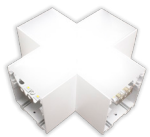

X Module
(page 7)

SCX-X-MCT4



Inside Corner Module
(page 7)

SCX-IC-MCT4



120° Corner Module
(page 8)

SCX-C120-MCT4



Y Module
(page 8)

SCX-Y-MCT4



L1FT Corner Module
(page 8)

SCX-L1FT-MCT4



6in Module
(page 9)

SCX-6IN-MCT4



9in Module
(page 9)

SCX-9IN-MCT4



LIGHTS SCX FLEXIBLE LENS ROLL 25FT OR 100FT

| Model | SIZE | DESCRIPTION | |
|--------------------|-------|---|---|
| SCX-FLEXLENS-25FT | 25FT | Flex lenses can be cut to different lengths, enabling precise customization according to the installation area. This allows for a seamless fit, reducing gaps or visible transitions between different sections of the SCX lights |  |
| SCX-FLEXLENS-100FT | 100FT | | |

MOUNTING OPTIONS:

FLANGLSS RECESSED INSTALLATION IN WOOD CEILING

No additional accessories required.

Make recessed preparations by installing a horizontal plank of wood on top of the wood ceiling at a recessed height of 3 3/8".

Screw and anchor kit provided with each fixture can be used to fasten the top of the fixture to the wood plank through the holes on top of the fixture.

You can also install vertical wood boards on top of the ceiling at the edge of the opening and open the fixture and put screws through the side of the fixture housing to fasten it to the wood boards.

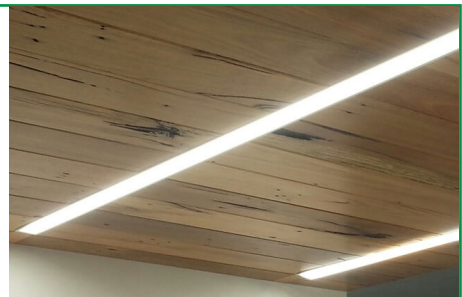

WALL MOUNTING

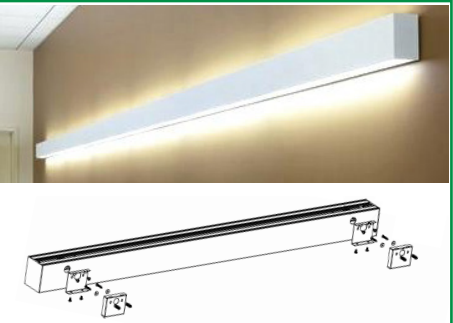
| Model | DESCRIPTION | |
|-----------------|--|--|
| OPT-SCX-WM-L1FT | Install this optional wall mounting brackets on the back of the fixture. Connection cables will enter the fixture through one of these wall-mounting brackets. On your purchase order, please specify the position of where your wire entry from the wall. |  |

RECESSED MOUNT WITH FLANGE

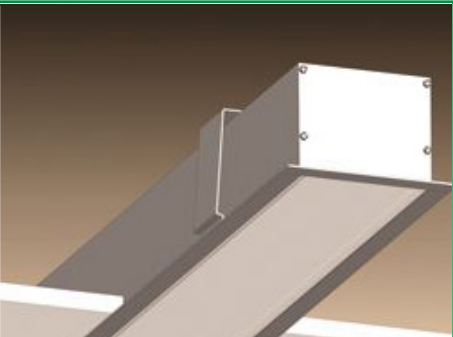
| Model | DESCRIPTION | |
|------------------|---|---|
| OPT-SCX-FMR-L1FT | Order this option and the fixture will be equipped with a 1/2" wide flange on four sides. Advanced design toggle-style brackets will also be provided, to adjust and hold the fixture against drywall or other hard ceilings from the top. When linking to another fixture or corner module, call us or send a copy of your plan along with your PO, and flanges will be removed on those ends that need to make a seamless connection. |  |

LINKING

| Model | DESCRIPTION |
|--------------------|--|
| OPT-SCX-LINKWIRING | Fixtures are equipped with pre-installed linking brackets and accessories and only need to be wired together. to receive a fixture prewired for linking, order the option below for each link to another fixture or a corner module. |



FLANGELESS RECESS MOUNT IN DRYWALL (MUD-IN)

| Model | DESCRIPTION |
|------------------|--|
| OPT-SCX-MIF-L1FT | Order this option and the fixture will be equipped with mud-in brackets on all four sides, mounted at 1/16" from the lens surface (specify if other spacing is needed). Advanced design toggle-style brackets will also be provided, to adjust and hold the fixture against the drywall ceiling from the top. When linking to another fixture or corner fixture module call us or send a copy of your plan along with your PO and flanges will be removed on those end that needs to make a seamless connection. |
| OPT-SCX-MIF-L | This is a L Module option. |
| OPT-SCX-MIF-T | This is a T Module option. |
| OPT-SCX-MIF-X | This is a X Module option. |
| OPT-SCX-MIF-IC | This is a Inside Corner Module option. |

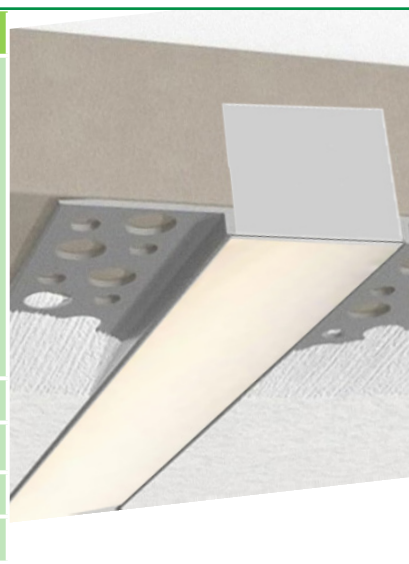

T-BAR INSTALLATION

| Model | DESCRIPTION |
|-------------------|---|
| OPT-SCX-TBAR-L1FT | Add this option and 1/2" wide flanges will be installed on the two long sides of the fixture. The two ends of the fixture will fall onto the T-bar grids and will be supported this way. The T-bar tiles on the two sides of the fixture must be cut to allow for the width of the fixture. The tile will fall onto and be supported by the flanges on both sides of the fixture. If you plan to support the fixture by the grids on three sides and tile on one side, call us or specify on your PO, and flange will be installed only on one side of the fixture. To provide safety and support from the beams above the T-bar ceiling order 10ft or 20ft aircraft suspension kits below. |
| SCL-GS10 | Adjustable 1/16" 10ft suspension kit with loop gripper & toggle ends hold up to 70 lbs load. |
| SCL-GS20 | Adjustable 1/16" 20ft suspension kit with loop gripper & toggle ends hold up to 70 lbs load. |
| OPT-FWH-63 | This is a 6FT 3-Wire Whip option. |
| OPT-FWH-65 | This is a 6FT 5-Wire Whip option. |
| OPT-FWH-66 | This is a 6FT 6-Wire Whip option. |



SURFACE MOUNTING

No additional accessories required.
Screw and anchor kit provided with each fixture can be used to fasten the fixture directly to the hard surface through the holes on top of the fixture.

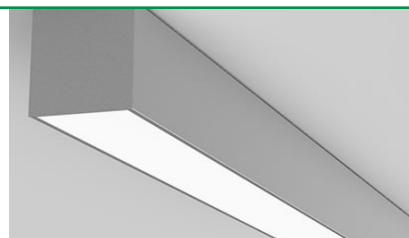

FACTORY-INSTALLED OPTIONS:

COLOR OF YOUR CHOICE

| Model | DESCRIPTION |
|--------------------|---|
| OPT-SCX-CLR-L1FT | Add this option and specify your desired color on your purchase order or provide a swatch to match. For painted flanged fixture or optional rod, mounting set please also add the relevant option below for each fixture. |
| OPT-SCX-CLR-FRM | This is a painted flanges option. |
| OPT-SCX-CLR-RODSET | This is a painted rod set option. |

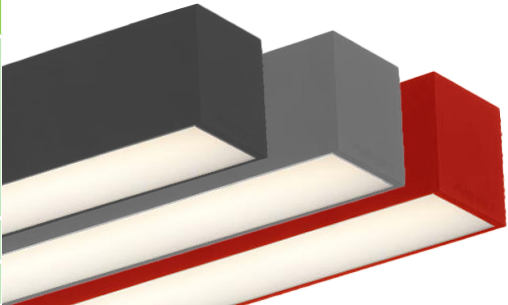

INDIRECT (UP) LIGHTING

| Model | WATTS | LUMENS | COLOR TEMP | SIZE |
|--------------------------|--------------------------------------|----------------------------------|----------------------------------|------|
| OPT-SCX-ULM-L1FT-8W-MCT4 | 8W | 800LM 824LM 840LM 864LM | 3000K 3500K 4000K 5000K | 2FT |
| OPT-SCX-ULM-BU | Indirect (up) light with blue color | | | |
| OPT-SCX-ULM-GR | Indirect (up) light with green color | | | |



EMERGENCY BATTERY BACKUP

| Model | DESCRIPTION |
|---------------|--|
| OPT-EM-CM1INT | This is an option for a 90-minute backup battery installation. If you need to order this series for the fixture, please have your purchase order ready and call us or specify on the order which fixture to install this option and the test button. |

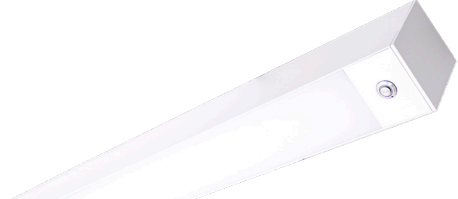

BI-LEVEL MOTION SENSOR

| Model | DESCRIPTION |
|----------------------|---|
| OPT-SCX-SEN2US | This option installs an advanced motion sensor that will turn the lights on when the area is occupied. When the area is cleared, after a preset hold time of 5 sec or more the lights are dimmed to a standby level of 30% or more. If still no motion is detected, after the standby period, the light is turned off. All setting is programmable with a remote control. |
| OPT-WEC-3RC | This is an optional remote control for sensor. |
| OPT-SEN-SCX-2MRLV-5 | This is a programmable microwave Bi-Level sensor. |
| OPT-SEN-2US-DAYLIGHT | It is an ultrasonic Bi-Level Dimming Daylight sensor option for internal installation inside the fixture. (Remote not needed) |

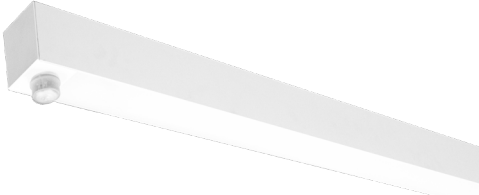

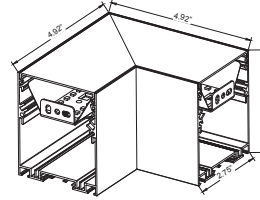
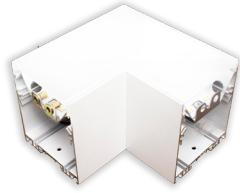

CORNER FIXTURE MODULES:

Built-in LED Modules

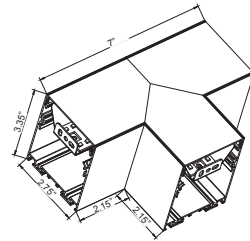

| Model | JOINT TYPE | LUMENS | MCT4 | DIMENSION |
|------------|------------|----------------------------------|----------------------------------|-------------------------------|
| SCX-L-MCT4 | L | 508LM 575LM 616LM 660LM | 3000K 3500K 4000K 5000K | 4.92" X 4.92" X 3.35" X 2.75" |



| Model | JOINT TYPE | LUMENS | COLOR TEMP | DIMENSION |
|------------|------------|----------------------------------|----------------------------------|------------------------------------|
| SCX-T-MCT4 | T | 629LM 726LM 787LM 854LM | 3000K 3500K 4000K 5000K | 7" X 3.35" X 2.75" X 2.15" X 2.15" |

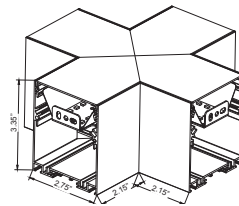
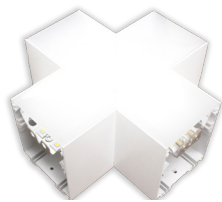

| Model | JOINT TYPE | LUMENS | COLOR TEMP | DIMENSION |
|------------|------------|-----------------------------------|----------------------------------|-------------------------------|
| SCX-X-MCT4 | X | 733LM 863LM 944LM 1037LM | 3000K 3500K 4000K 5000K | 3.35" X 2.75" X 2.15" X 2.15" |

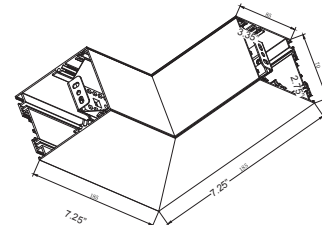

| Model | JOINT TYPE | LUMENS | COLOR TEMP | DIMENSION |
|-------------|---------------|----------------------------------|----------------------------------|-------------------------------|
| SCX-IC-MCT4 | INSIDE CORNER | 629LM 726LM 787LM 854LM | 3000K 3500K 4000K 5000K | 7.25" X 7.25" X 3.35" X 2.75" |



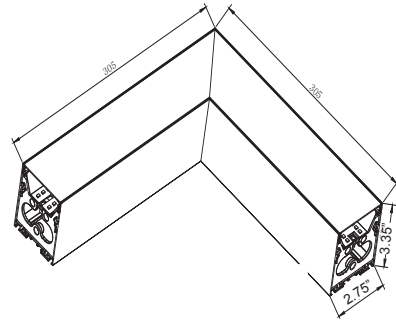
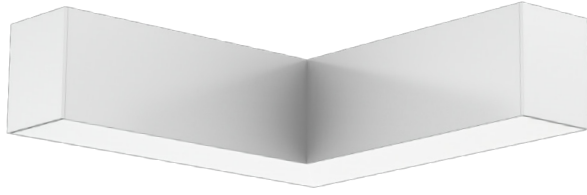

| Model | JOINT TYPE | LUMENS | COLOR TEMP | DIMENSION |
|---------------|------------|--------------------------------------|----------------------------------|---------------------------|
| SCX-L1FT-MCT4 | L FIXTURE | 2197LM 2316LM 2348LM 2390LM | 3000K 3500K 4000K 5000K | 12" X 12" X 3.35" X 2.75" |

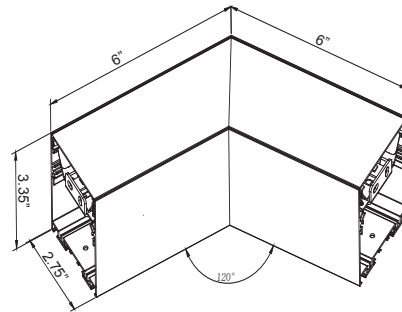

| Model | JOINT TYPE | LUMENS | COLOR TEMP | DIMENSION |
|---------------|-------------|----------------------------------|----------------------------------|-------------------------|
| SCX-C120-MCT4 | 120° CORNER | 508LM 575LM 616LM 660LM | 3000K 3500K 4000K 5000K | 6" X 6" X 3.35" X 2.75" |

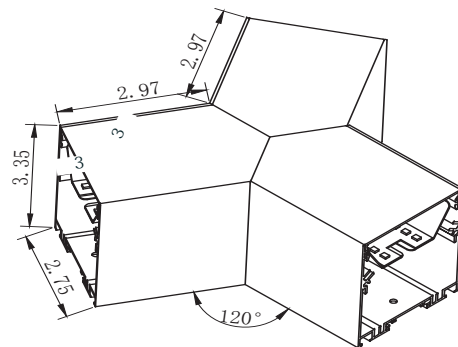
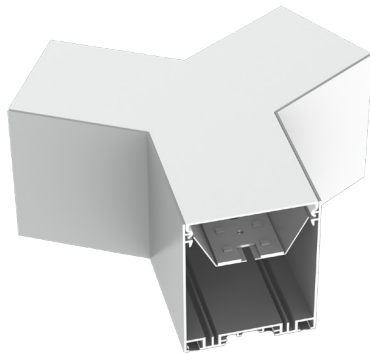

| Model | JOINT TYPE | LUMENS | COLOR TEMP | DIMENSION |
|------------|------------|----------------------------------|----------------------------------|-------------------------|
| SCX-Y-MCT4 | Y | 508LM 575LM 616LM 660LM | 3000K 3500K 4000K 5000K | 3" X 3" X 3.35" X 2.75" |



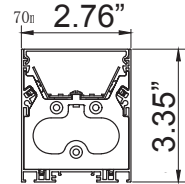
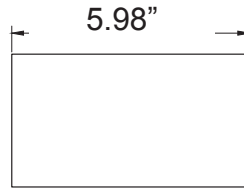
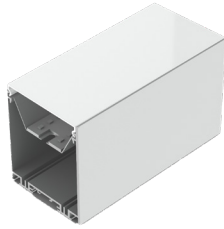

| Model | JOINT TYPE | LUMENS | COLOR TEMP | DIMENSION |
|--------------|------------|----------------------------------|----------------------------------|-----------------------|
| SCX-6IN-MCT4 | 6in Module | 508LM 575LM 616LM 660LM | 3000K 3500K 4000K 5000K | 5.98" X 2.76" X 3.35" |

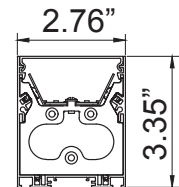
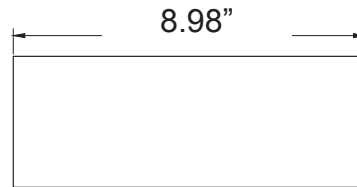
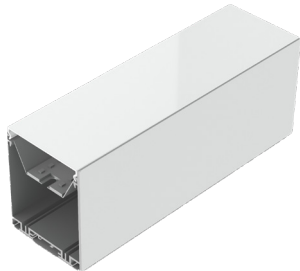

| Model | JOINT TYPE | LUMENS | COLOR TEMP | DIMENSION |
|--------------|------------|----------------------------------|----------------------------------|-----------------------|
| SCX-9IN-MCT4 | 9in Module | 508LM 575LM 616LM 660LM | 3000K 3500K 4000K 5000K | 8.98" X 2.76" X 3.35" |



COLOR CHART: * Choose from one of our Premium Colors with no set-up fee.

Gloss:



SILVER METALLIC
70 GLOSS
T357-GR105



SILVER METALLIC
30 GLOSS
T353-GR06



DARK RED 90
GLOSS
P009-RD02



INTERNATIONAL
ORANGE 90
GLOSS
T009-OG26



SAFETY ORANGE
90 GLOSS
T009-OG01



YELLOW 90
GLOSS
T009-YL14



YELLOW 90
GLOSS
T009-YL01



TRAFFIC GREEN
70 GLOSS
T007-GN16



GREEN 70 GLOSS
T007-GN13



GREEN 60 GLOSS
C006-GN03



BLUE 90 GLOSS
T009-BL01



DARK BLUE 80
GLOSS
T008-BL20



RAL 8028 TERRA
BROWN 90 GLOSS
C209-BR358

Hammer:



WHITE HAMMER
T013-WH09



BEIGE HAMMER
T013-BG38



GREY HAMMER
C013-GR08

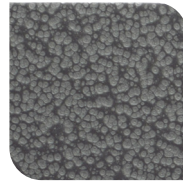

SILVER
HAMMERTONE
T064-GR05



BLACK HAMMER
T013-BK62

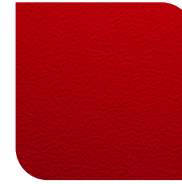

RED HAMMER
T013-RD15

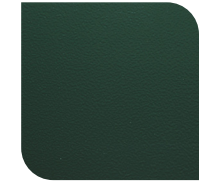

GREEN HAMMER
T013-GN220

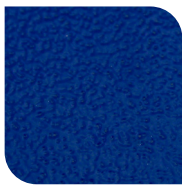

BLUE HAMMER
T013-BL468



BRONZE HAMMER
T012-BR161

Texture:



WHITE TEXTURE
C031-WH120



FLINT GRAY
TEXTURE
T243-GR522



BLACK TEXTURE
C241-BK109



RED TEXTURE
T241-RD129



BLUE TEXTURE
C241-BL544



OIL RUBBED
BRONZE TEXTURE
T291-BR251

Vein:



BLACK/WHITE
VEIN
T075-WH34

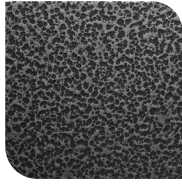

SILVER VEIN
T375-BK26

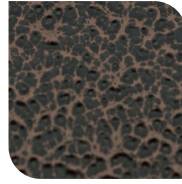

COPPER VEIN
EXTERIOR
T075-BK211



GOLD VEIN
T375-BK10



COPPER VEIN
T375-BK07

