

SCX SERIES Commercial Lighting

SCX-4FT-RGBWW-BT
WG SMART APP COMPATIBLE SCX LINEAR LIGHTS

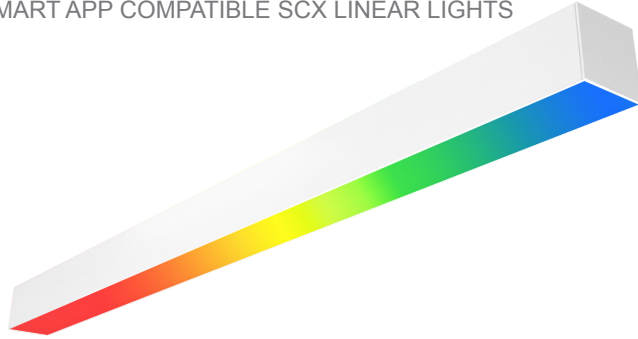

The SCX series offers the best and the most comprehensive selection for linear lighting. The various available lengths and widths allow the creation of the desired shape to elevate the areas aesthetics to a unique and modern look while providing an impressive illumination for the occupants. Ideal for, retail locations, offices, lobbies, conference rooms, reception areas, hallways, educational facilities, hotels, and restaurants. FEATURES: Superior Architectural Look Energy-efficient: Low Wattage Consumption & High Lumen Output Easier Wire Management & Install Variety of Mounting Options Multi Color Temperature (Selectable Switch Inside Fixture) Variety Of Factory Customizations Available

WESTGATE
THE FUTURE IS HERE...AND IT'S QUITE BRIGHT!

Customer Name: _____

Project Name: _____

Note: _____

Type: _____

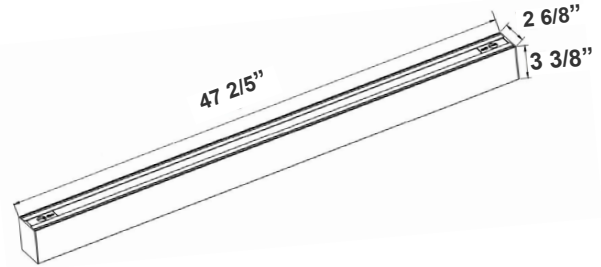

47 2/5"(L) x 2 6/8"(W) x 3 3/8"(H)

Features

- LED Superior Architectural Lights
- Seamless Linkable Linear Lighting System
- Opal Polycarbonate Lens-Direct (DOWN) Lighting
- Optional Recessed & Wall Mounting Kits Available
- Optional Louver Version Lens Available
- Lens Type: Opal Polycarbonate Lens

Technical Specifications

Electrical:

- Voltage: 120-277VAC 50/60Hz
- Wattage: 40W
- Power Factor: >0.95
- Total Harmonic Distortion: ≤ 20 %
- Efficacy: 110 LPW
- Bluetooth Connection Range: Approximately 30 feet (10 meters). Maximum Communication Range Will Vary Depending On Obstacles (Person, Metal, Wall, etc.) Or Electromagnetic Environment

Mechanical:

- Low Profile Modern Design
- Aluminum Housing With Matte White Finish
- Custom Colors Available
- Lens Snaps into Housing
- Make Different Connections Via T/L/X Joints on Both Ends
- Mounting Options: Surface, Suspended, Wall, Recessed
- IP Rating: IP54
- Operating Temperature: -13°F~104°F
- Adjustable Suspension Brackets Provided on Top of The Fixtures
- 5-Year Warranty

Lighting:

- Dimmable: 0~10V Dimming
- Total Lumens: 4400LM
- Color Temperatures: RGB
- Color Rendering Index: CRI ≥ 80
- Up Light Option Available
- 50,000 Hours Rated Life
- Beam Angle: 104.8°(H) x 100.5°(V)

Applications:

- Ideal for offices, hotels, corridors, saloons, libraries, meeting rooms, conference halls, and the best solution for modern lighting solutions
- It can be used in any indoor applications



Phone: (877) 805-2252 | Fax: (877) 805-2252
www.westgatemfg.com |



Photometrics: SCX-4FT-RGBWW-BT

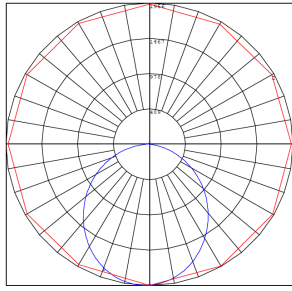
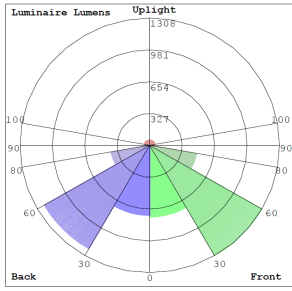

BUD Rating: B2-U3-G1

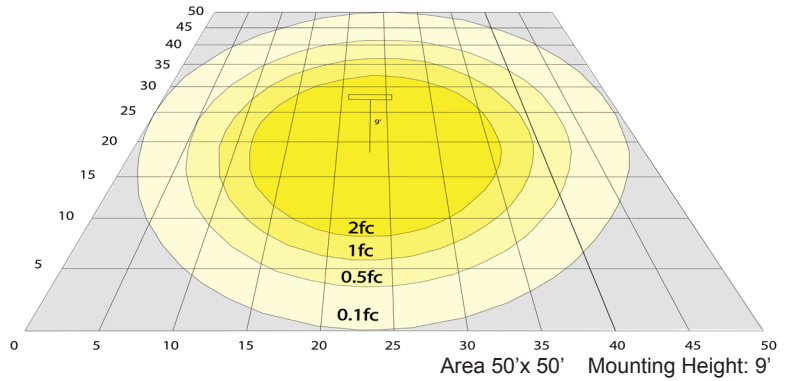

Area 50'x 50' Mounting Height: 9'

Other Views:



Front View

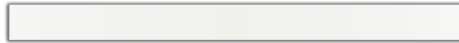

Side View



Back View

Performance Table: SCX-4FT-RGBWW-BT

MODEL NO.	Wattage	Voltage	Lumens	Color Temp.	BUG Rating	LPW
SCX-4FT-RGBWW-BT	40W	120~277V	4400LM	RGB	B1-U2-G1	110

Sample Ordering

Model Size Color Temp. Feature

SCX - 4FT - RGBWW - BT

Accessories:

Blank = No Option For Accessories

SCL-CS1-6FT = ADJ. 6FT 1/16in SINGLE SUSPENSION CANOPY SET WITH KEYHOLE END CONNECTOR, NON-POWER SIDE

SCL-CS1P-6FT = ADJ. 6FT 1/16in SINGLE SUSPENSION CANOPY SET WITH KEYHOLE END CONNECTOR, POWER SIDE WITH SJTW18/5 WHITE CORD

SCL-CS1P-6FT-NC = ADJ. 6FT 1/16in SINGLE SUSPENSION CANOPY SET WITH KEYHOLE END CONNECTOR

SCL-CSK-6FT = ADJ. 6FT 1/16in SUSPENSION CANOPY COMPLETE KIT FOR BOTH SIDES WITH KEYHOLE END CONNECTORS SCL-GS10 = ADJ. 10FT 1/16in DOUBLE SUSPENSION CABLE WITH SINGLE KEYHOLE CONN., LOOP GRIPPER ON TOP

SCL-GS20 = ADJ. 20FT 1/16in DOUBLE SUSPENSION CABLE WITH SINGLE KEYHOLE CONN., LOOP GRIPPER ON TOP

SCL-6FT-SJTW18/5 = 6ft White Cord, SJTW 18 AWG 5-Conductor (Black, White, Green + Purple & Gray for 0-10V Dimming)

SCL-6FT-SJTW18/5-100FT = 100ft Roll of White Cord, SJTW 18 AWG 5-Conductor (Black, White, Green + Purple & Gray for 0-10V Dimming)

SCL-6FT-SJTW18/5-100FT-BK = 100ft Roll of Black Cord, SJTW 18 AWG 5-Conductor (Black, White, Green + Purple & Gray for 0-10V Dimming)

SCL-6FT-SJTW18/6-100FT = 100ft Roll of Black Cord, SJTW 18 AWG 6-Conductor (Black, White, Green + Purple & Gray for 0-10V Dimming + Red for Backup Inverter)

SCL-AH = Heavy-Duty Auxiliary Hook for Up To 1/16" Aircraft Cable

SCL-ASC-500FT = 1/16" 500 ft. Steel Aircraft Cable Suspension

TC-RGBW-RC = OPTIONAL REMOTE CONTROL COMPATIBLE WITH WESTGATE SMART APP CONTROL DEVICES, ALLOWING EASY MANAGEMENT OF RGBW LIGHTING SETTING REMOTELY

Factory-Installed Options:

Blank = No Option For Accessories

OPT-HBC-125BS-WH = 10FT, 15A, 125V, 18/3 STR, WHT

SUSPENDED MOUNTING ACCESSORIES (NOT INCLUDED)



FACTORY-INSTALLED OPTIONS:



- For Setting Up The Light(s), Initial Internet Connection or Mobile Data Is Required.
- After the Initial Setup, Internet Connection is not Necessary Anymore. The lights Can Be Controlled with The Mobile App on The Phone or Tablet. Features Such as Dimming, Changing Colors, Lights Scenes, etc.
- Scheduling Feature Requires Internet Connection.
- Bluetooth Devices Need a Gateway (Sold Separately) In Order to Connect to WiFi Network (Internet)



MOUNTING AND MODULES OPTIONS:

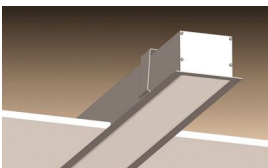

Recessed Mounted
(Flanged)



Surface Mounted

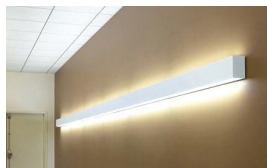

Wall Mounted



Suspended



T-Bar Installation

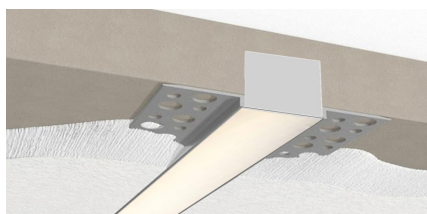

Flangless Recessed Mounted
(Mud-In)

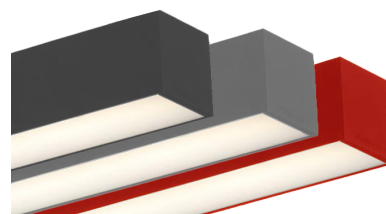

Color of Your Choice

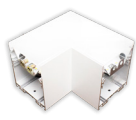

L Module
(page 7)
SCX-L-MCT4



T Module
(page 7)
SCX-T-MCT4

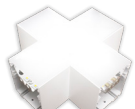

X Module
(page 8)
SCX-X-MCT4



Inside Corner Module
(page 8)
SCX-IC-MCT4



120° Corner Module
(page 9)
SCX-C120-MCT4



Y Module
(page 9)
SCX-Y-MCT4



C60 Module
(page 9)
SCX-C60-MCT4



Outside Corner Module
(page 9)
SCX-OC-MCT4



6in Module
(page 9)
SCX-6IN-MCT4



9in Module
(page 9)
SCX-9IN-MCT4



MOUNTING OPTIONS:

FLANGLESS RECESSED INSTALLATION IN WOOD CEILING

No additional accessories required.
 Make recessed preparations by installing a horizontal plank of wood on top of the wood ceiling at a recessed height of 3 3/8".
 Screw and anchor kit provided with each fixture can be used to fasten the top of the fixture to the wood plank through the holes on top of the fixture.
 You can also install vertical wood boards on top of the ceiling at the edge of the opening and open the fixture and put screws through the side of the fixture housing to fasten it to the wood boards.

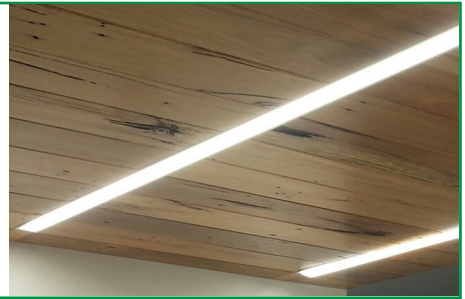

SUSPENSION ROD KITS (SET OF 2)

Model	SIZE
SCL-RS-12	12 IN
SCL-RS-18	18 IN
SCL-RS-24	24 IN
SCL-RS-36	36 IN
SCL-RS-48	48 IN

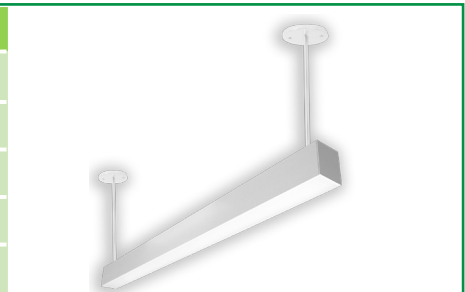

WALL MOUNTING

Model	DESCRIPTION
OPT-SCX-WM-4FT	Install this optional wall mounting brackets on the back of the fixture. Connection cables will enter the fixture through one of these wall-mounting brackets. On your purchase order, please specify the position of where your wire entry from the wall.

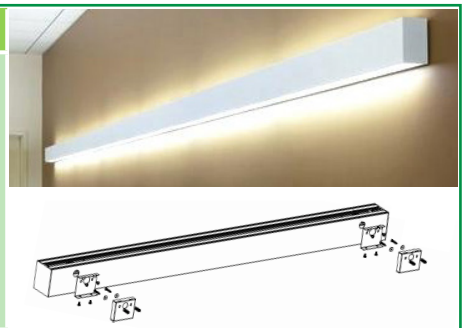

WALL MOUNTING

Model	DESCRIPTION
OPT-SCX-WMA-4FT	Add this option to the fixture, and wall mount brackets will be installed on the back of the fixture. A connection cable will enter the fixture through one of these wall-mounting brackets. On your purchase order, specify the position of your wire entry from the wall, and the brackets will be installed on the back accordingly.

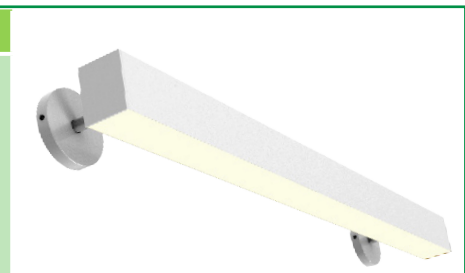

RECESSED MOUNT WITH FLANGE

Model	DESCRIPTION
OPT-SCX-FMR-4FT	Order this option and the fixture will be equipped with a 1/2" wide flange on four sides. Advanced design toggle-style brackets will also be provided, to adjust and hold the fixture against drywall or other hard ceilings from the top. When linking to another fixture or corner module, call us or send a copy of your plan along with your PO, and flanges will be removed on those ends that need to make a seamless connection.

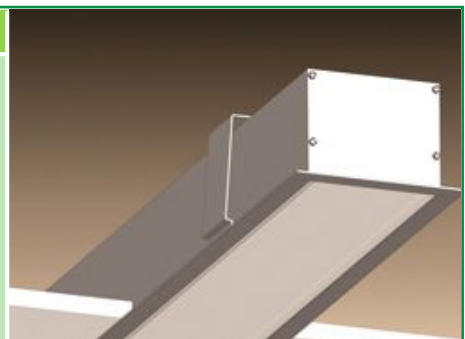

LINKING

Model	DESCRIPTION
OPT-SCX-LINKWIRING	Fixtures are equipped with pre-installed linking brackets and accessories and only need to be wired together. To receive a fixture prewired for linking, order the option below for each link to another fixture or a corner module.

FLANGELESS RECESS MOUNT IN DRYWALL (MUD-IN)

Model	DESCRIPTION
OPT-SCX-MIF-4FT	Order this option and the fixture will be equipped with mud-in brackets on all four sides, mounted at 1/16" from the lens surface (specify if other spacing is needed). Advanced design toggle-style brackets will also be provided, to adjust and hold the fixture against the drywall ceiling from the top. When linking to another fixture or corner fixture module call us or send a copy of your plan along with your PO and flanges will be removed on those end that needs to make a seamless connection.
OPT-SCX-MIF-L	This is a L Module option.
OPT-SCX-MIF-T	This is a T Module option.
OPT-SCX-MIF-X	This is a X Module option.
OPT-SCX-MIF-IC	This is a Inside Corner Module option.

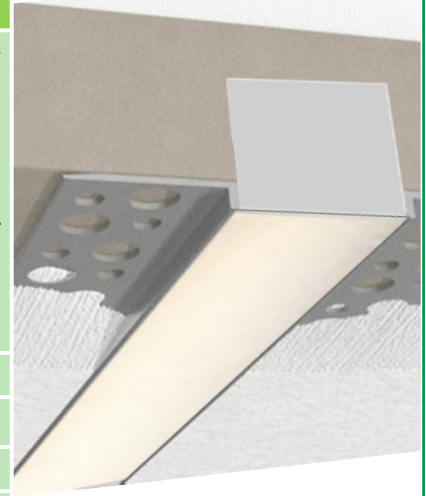

T-BAR INSTALLATION

Model	DESCRIPTION
OPT-SCX-TBAR-4FT	Add this option and 1/2" wide flanges will be installed on the two long sides of the fixture. The two ends of the fixture will fall onto the T-bar grids and will be supported this way. The T-bar tiles on the two sides of the fixture must be cut to allow for the width of the fixture. The tile will fall onto and be supported by the flanges on both sides of the fixture. If you plan to support the fixture by the grids on three sides and tile on one side, call us or specify on your PO, and flange will be installed only on one side of the fixture. To provide safety and support from the beams above the T-bar ceiling order 10ft or 20ft aircraft suspension kits below.
SCL-GS10	Adjustable 1/16" 10ft suspension kit with loop gripper & toggle ends hold up to 70 lbs load.
SCL-GS20	Adjustable 1/16" 20ft suspension kit with loop gripper & toggle ends hold up to 70 lbs load.
OPT-FWH-63	This is a 6FT 3-Wire Whip option.
OPT-FWH-65	This is a 6FT 5-Wire Whip option.
OPT-FWH-66	This is a 6FT 6-Wire Whip option.



SCL-GS10 SCL-GS20



SURFACE MOUNTING

No additional accessories required. Screw and anchor kit provided with each fixture can be used to fasten the fixture directly to the hard surface through the holes on top of the fixture.

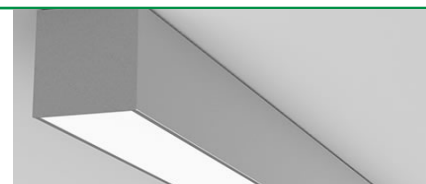

LIGHTS SCX FLEXIBLE LENS ROLL 25FT OR 100FT

Model	SIZE	DESCRIPTION
SCX-FLEXLENS-25FT	25FT	Flex lenses can be cut to different lengths, enabling precise customization according to the installation area. This allows for a seamless fit, reducing gaps or visible transitions between different sections of the SCX lights
SCX-FLEXLENS-100FT	100FT	



FACTORY-INSTALLED OPTIONS:

LOUVER VERSION

Model	DESCRIPTION	LUMENS @ 4000K	SIZE
OPT-SCX-LUV-4FT	This Louver option includes lens inside.	4320LM	4FT



COLOR OF YOUR CHOICE

Model	DESCRIPTION
OPT-SCX-CLR-4FT	Add this option and specify your desired color on your purchase order or provide a swatch to match. For painted flanged fixture or optional rod, mounting set please also add the relevant option below for each fixture.
OPT-SCX-CLR-FRM	This is a painted flanges option.
OPT-SCX-CLR-RODSET	This is a painted rod set option.

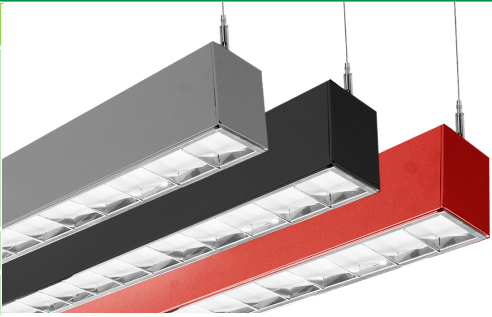

EMERGENCY BATTERY BACKUP

Model	DESCRIPTION
OPT-EM-SCX-4FT	This is an option for a 90-minute backup battery installation. If you need to order this series for the fixture, please have your purchase order ready and call us or specify on the order which fixture to install this option and the test button.

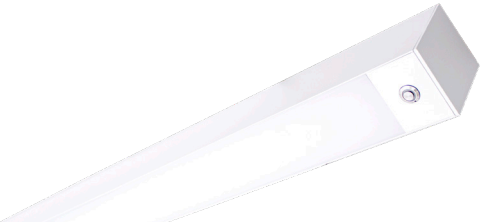

BI-LEVEL MOTION SENSOR

Model	DESCRIPTION
OPT-SCX-SEN2US	This option installs an advanced motion sensor that will turn the lights on when the area is occupied. When the area is cleared, after a preset hold time of 5 sec or more the lights are dimmed to a standby level of 30% or more. If still no motion is detected, after the standby period, the light is turned off. All setting is programmable with a remote control.
OPT-WEC-3RC	This is an optional remote control for sensor.
OPT-SEN-SCX-2MRLV-5	This is a programmable microwave Bi-Level sensor.
OPT-SEN-2US-DAYLIGHT	It is an ultrasonic Bi-Level Dimming Daylight sensor option for internal installation inside the fixture. (Remote not needed)

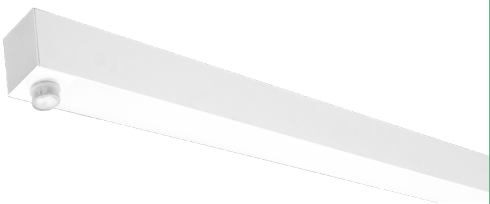

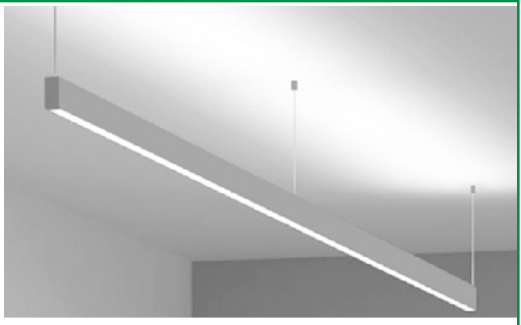

INDIRECT (UP) LIGHTING

Model	DESCRIPTION	
OPT-SCX-ULM-4FT-RGB	SCX 4Ft Rgb Uplight Module And	

WOOD TRIMS

Model	DESCRIPTION					
OPT-SCX-WK01-4FT-MAPLE	4FT MAPLE FINISH	 <table border="1" data-bbox="1224 621 1497 898"> <tr> <td>MAPLE</td> <td>WALNUT</td> </tr> <tr> <td>FRENCH OAK</td> <td>EBONY</td> </tr> </table>	MAPLE	WALNUT	FRENCH OAK	EBONY
MAPLE	WALNUT					
FRENCH OAK	EBONY					
OPT-SCX-WK01-4FT-WALNUT	4FT WALNUT FINISH					
OPT-SCX-WK01-4FT-FREOAK	4FT FRENCH OAK FINISH					
OPT-SCX-WK01-4FT-EBONY	4FT EBONY FINISH					

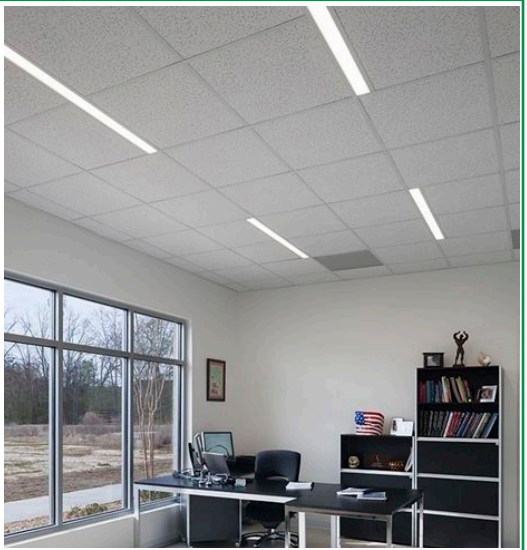
T-BAR INSTALLATION

Model	DESCRIPTION	
OPT-SCX-TBAR-4FT 4FT	<p>Add this option to the fixture, and 1/2" wide flanges will be installed on the two long sides of the fixture. The two fixture ends will fall onto the t-bar grids and will be supported this way. The t-bar tiles on the two sides of the fixture must be cut to allow for the fixture's width. The tiles will fall onto and be supported by the flanges on both sides of the fixture. If you plan to support the fixture by the grids on three sides and tile on one side, call us or specify on your po, and the flange will be installed only on one side of the fixture. To provide safety and support from the beams above the t-bar ceiling, order 10ft or 20ft aircraft suspension kits below.</p>	

SCX INSTALLED ACOUSTIC OPTIONS

Model	DESCRIPTION	
OPT-SCX-AK-4FT-9MM-HY2210	9mm Fiber Acoustic Kit, Dark Blue	
OPT-SCX-AK-4FT-9MM-HY2204	9mm Fiber Acoustic Kit, Dark Gray	



WALL GRAZER KIT OPTIONS

Model	DESCRIPTION
OPT-SCX-WGRZR-2FT	Wall Grazer Kit, Zinc materials, The installation depth can be maximum 2inch

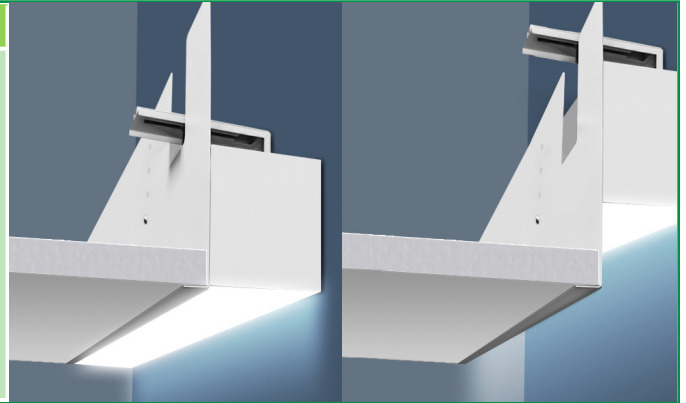

CORNER FIXTURE MODULES:

Built-in LED Modules

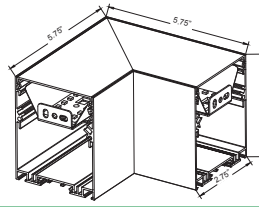
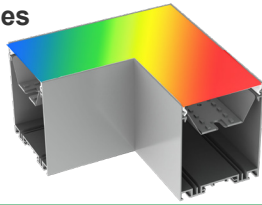

Model	JOINT TYPE	DESCRIPTION	MCT4	DIMENSION
SCX-L-RGBWW	L	SCX 2.75 in Linear L Section	3000K 3500K 4000K 5000K RGB	5.75" X 5.75" X 3.35" X 2.75"

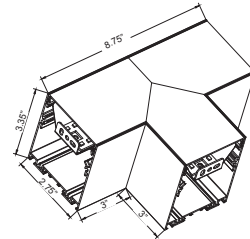
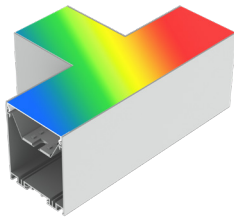

Model	JOINT TYPE	DESCRIPTION	COLOR TEMP	DIMENSION
SCX-T-RGBWW	T	SCX 2.75 in Linear T Section	3000K 3500K 4000K 5000K RGB	8.75" X 3" X 3" X 3.35" X 2.75"

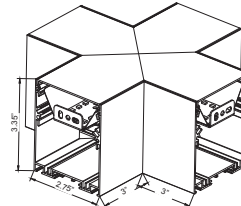
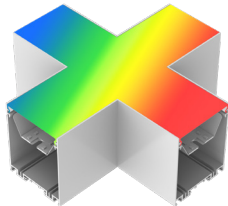

Model	JOINT TYPE	DESCRIPTION	COLOR TEMP	DIMENSION
SCX-X-RGBWW	X	SCX 2.75 in Linear X Section	3000K 3500K 4000K 5000K RGB	3" X 3" X 3.35" X 2.75"

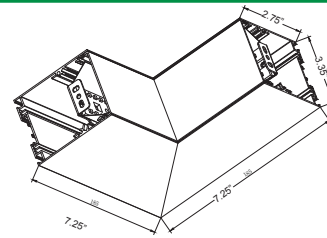
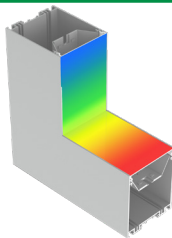

Model	JOINT TYPE	DESCRIPTION	COLOR TEMP	DIMENSION
SCX-IC-RGBWW	INSIDE CORNER	SCX 2.75 in Linear Inside Corner	3000K 3500K 4000K 5000K RGB	7.25" X 7.25" X 3.35" X 2.75"



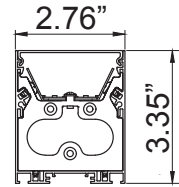
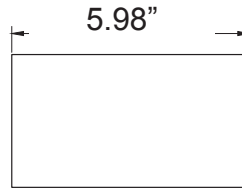
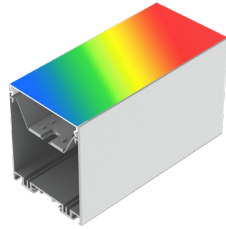

Model	JOINT TYPE	DESCRIPTION	COLOR TEMP	DIMENSION
SCX-6IN-RGBWW	6in Module	SCX 2.75 in Linear 6In Section	3000K 3500K 4000K 5000K RGB	5.98" X 2.76" X 3.35"

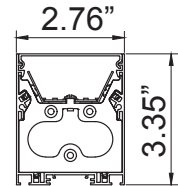
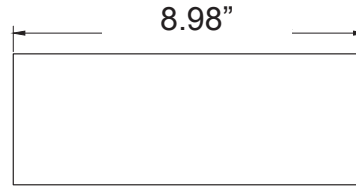
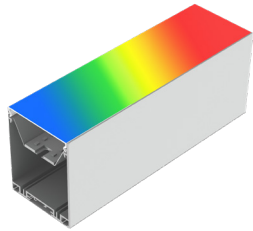

Model	JOINT TYPE	DESCRIPTION	COLOR TEMP	DIMENSION
SCX-9IN-RGBWW	9in Module	SCX 2.75 in Linear 9In Section	3000K 3500K 4000K 5000K RGB	8.98" X 2.76" X 3.35"

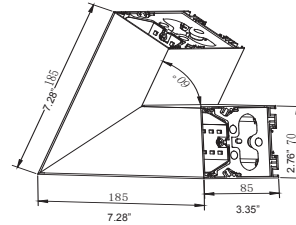
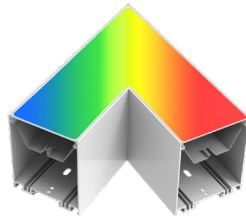

Model	JOINT TYPE	DESCRIPTION	COLOR TEMP	DIMENSION
SCX-C60-RGB- WW	60° CORNER	SCX Mct4 60-Degree Corner	3000K 3500K 4000K 5000K RGB	7.28" X 7.28" X 3.35" X 2.76"

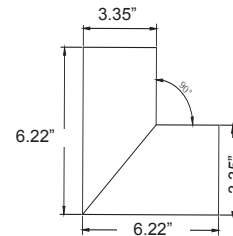
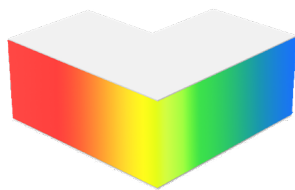

Model	JOINT TYPE	DESCRIPTION	COLOR TEMP	DIMENSION
SCX-OC-RGBWW	OUTSIDE CORNER	SCX 2.75 in Linear Outside Corner	3000K 3500K 4000K 5000K RGB	6.22" X 6.22" X 3.35" X 2.75"



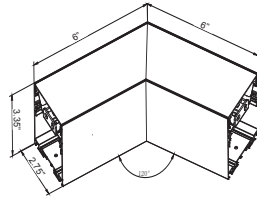
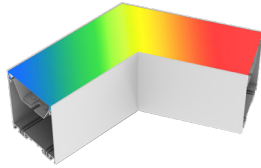

Model	JOINT TYPE	DESCRIPTION	COLOR TEMP	DIMENSION
SCX-C120-RGBWW	120° CORNER	SCX 2.75 in Linear 120D Section	3000K 3500K 4000K 5000K RGB	6" X 6" X 3.35" X 2.75"

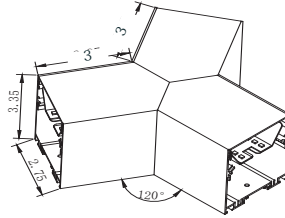
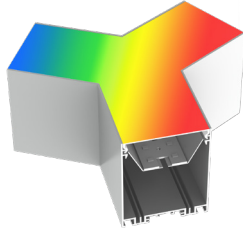

Model	JOINT TYPE	DESCRIPTION	COLOR TEMP	DIMENSION
SCX-Y-RGBWW	Y	SCX 2.75 in Linear Y Section	3000K 3500K 4000K 5000K RGB	3" X 3" X 3.35" X 2.75"



COLOR CHART: * Choose from one of our Premium Colors with no set-up fee.

Gloss:



Hammer:

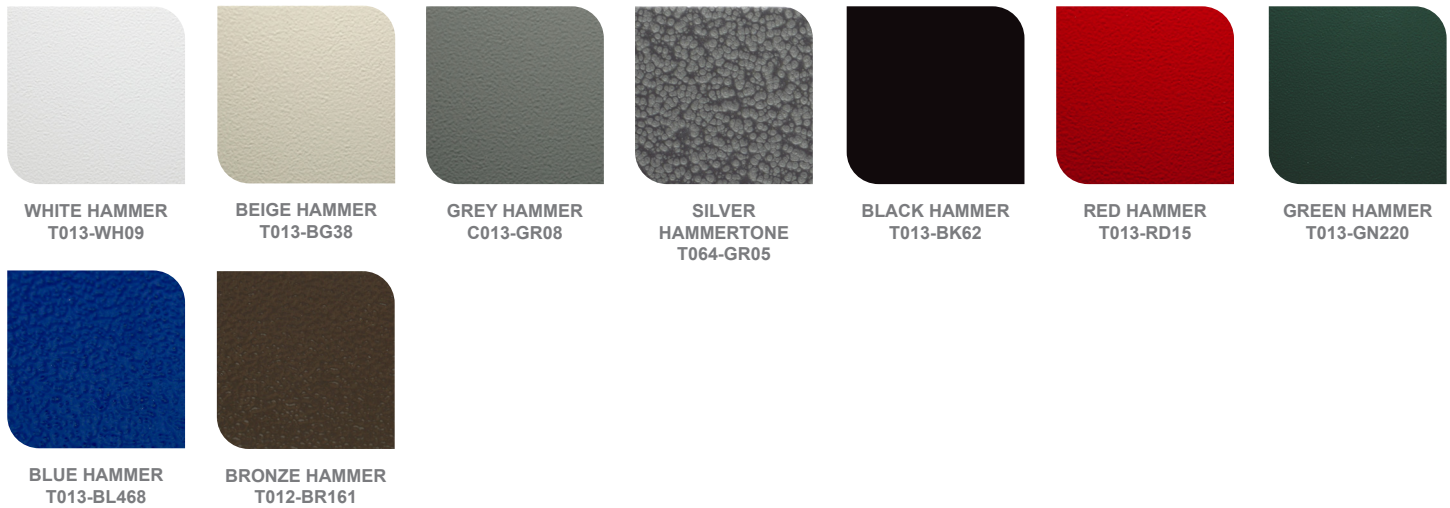

Texture:



Vein:

