

SCSSL SERIES

SCSSL-UD-AP-4FT-MCTP

SCSSL-UD-AP-4FT-MCTP-BK

ARCHITECTURAL 0.4" SLIM UP&DOWN /W SEPARATE CONTROLS LINEAR LIGHT

MCTP Multi Color Temperature & Multi Power/Wattage (Selectable)

WESTGATE

THE FUTURE IS HERE...AND IT'S QUITE BRIGHT!

Customer Name: _____

Project Name: _____

Note: _____

Type: _____

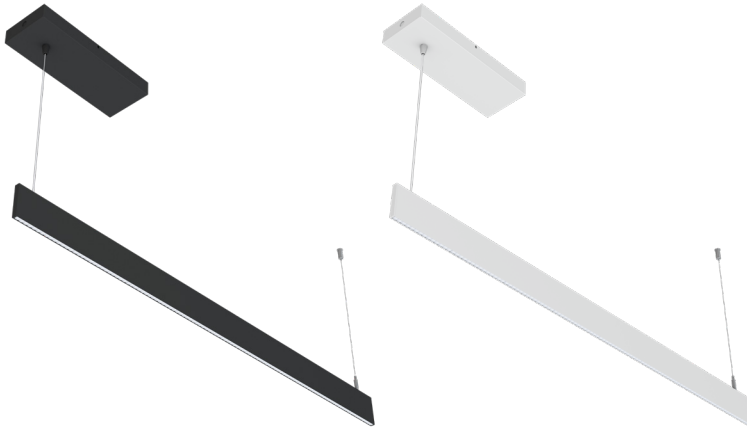

Avail Finish:



A modern decorative Euro-design suspended light suitable for conference tables, creative offices and department stores.

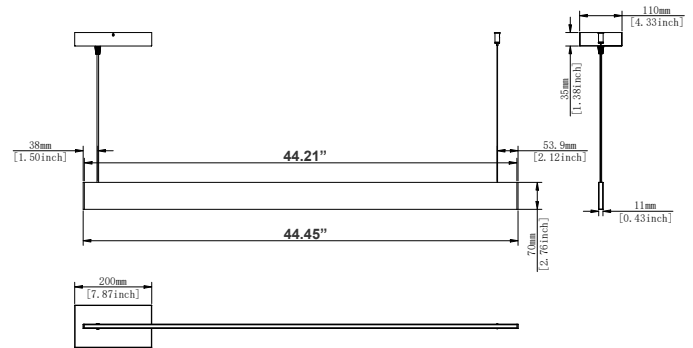

Canopy Dimension: 44.21"(W) x 1.38"(H) x 4.33"(D)

Fixture Dimension: 44.45"(W) x 2.79"(H) x 7.87"(D)

Features

- LED Superior Architectural Lights
- Aperture Optics Lens
- Aluminum Housing With Sandy White and Black Finish
- MCTP: Multi Color Temperature and Power (Selectable, the switches are inside the Canopy)
- 5-Year Warranty

Technical Specifications

Electrical:

- Voltage: 120-277V AC 50/60Hz
- Wattage: 10W/15W/20W
- Power Factor: >0.9
- LPW: 70LM/W
- Total Harmonic Distortion: ≤19 %

Mechanical:

- Aluminum Housing With Sandy Black and White Finish
- Two 10FT Adjustable Suspension Cables with Canopies Included
- Lens: Aperture Optics Lens
- Operating Temperature: -22°F to +104°F
- IP Rating: IP20, Suitable for damp location
- 5-Year Warranty

Lighting:

- Dimming: (Dual Function) Triac Dimmable at 120V & 0-10V Dimming at 120-277V
- Total Lumens: 1400LM Max.
- Color Temperatures: 2700K/3000K/3500K/4000K/5000K
- MCTP: Multi Color Temperature and Power (Selectable, the switches are inside the Canopy)
- Color Rendering Index: CRI ≥ 80
- 50,000 Hours Rated Life
- Beam Angle: 120°

Applications:

- Ideal for offices, hotels, corridors, saloons, libraries, meeting rooms, conference halls, and the best solution for modern lighting solutions
- It can be used in any indoor applications



Phone: (877) 805-2252 | Fax: (877) 805-2252
www.westgatemfg.com



WG-04102022

Photometrics: SCSSL-UD-AP-4FT-MCTP

BUG rating

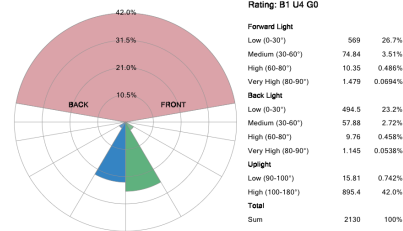

Rating: B1 U4 G0

Category	Sub-Category	Value	Percentage
Forward Light	Low (0-30°)	569	26.7%
	Medium (30-60°)	74.84	3.51%
	High (60-90°)	10.35	0.486%
	Very High (90-180°)	1.279	0.0694%
Back Light	Low (0-30°)	494.5	23.2%
	Medium (30-60°)	57.88	2.72%
	High (60-90°)	9.76	0.458%
	Very High (90-90°)	1.145	0.0538%
Uplight	Low (90-180°)	15.81	0.742%
	High (100-180°)	855.4	42.0%
	Total	2130	100%

IESNA TM-15-07 Luminaire Classification System For Outdoor Luminaires

BUD Rating: B1-U4-G1

Iso-illuminance plot

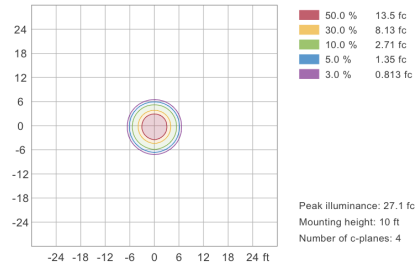

Performance Table: SCSSL-UD-AP-4FT-MCTP

MODEL NO.	Wattage	Voltage	Lumens	Color Temp.	BUG Rating	LPW
SCSSL-UD-AP-4FT-MCTP	10W	120~277V	700	2700K	B1-U4-G1	70
SCSSL-UD-AP-4FT-MCTP-BK	15W		1050	3000K		
	20W		1400	3500K		
				4000K		
				5000K		

Sample Ordering

Model Direction Lens Size Color Temp. Finish

SCSSL - UD - AP - 4FT - MCTP -

BK = Black
WH = White

Accessories:

- Blank = No Option For Accessories
- SCSSL-REC = SCSSL Rounded End Cap
- SCSSL-REC-BK = SCSSL Rounded End Cap. Black
- SCSSL-CEC = SCSSL Coupling End Cap
- SCSSL-CEC-BK = SCSSL Coupling End Cap

Factory-Installed Options:

- Blank = No Option For Accessories
- OPT-EM-SCSL-WH = Factory-Installed EM option, Installed in Deeper Canopy, White
- OPT-EM-SCSL-BK = Factory-Installed EM option, Installed in Deeper Canopy, Black

ACCESSORIES:

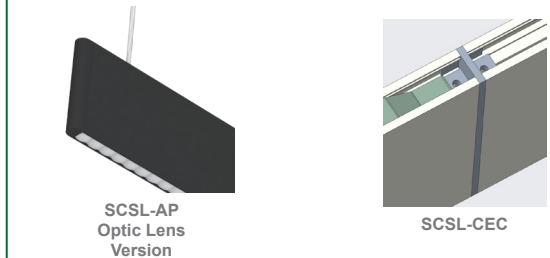
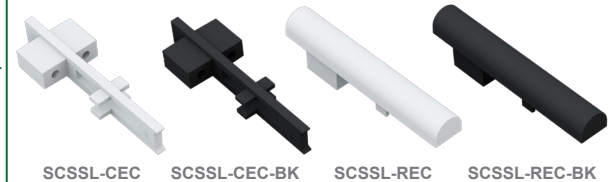

FACTORY-INSTALLED OPTIONS:

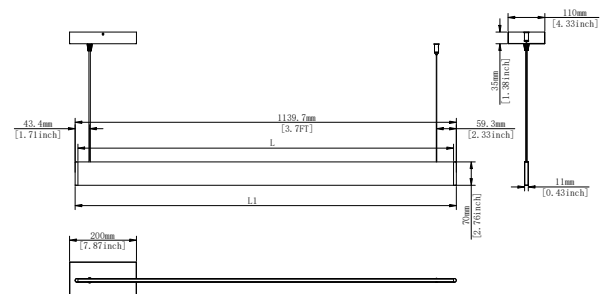
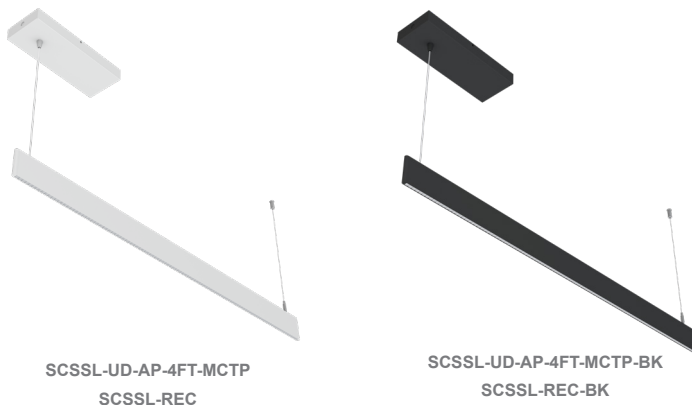
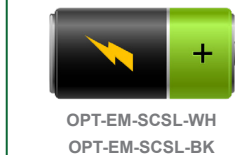

SCSSL-UD-AP-4FT-MCTP
SCSSL-REC
3.7"(W) x 2.76"(H) x 4.33"(D)

