

LWAX SERIES Outdoor Lighting

LWAX-LG-50-120W-MCTP-P
GEN. 2 ADJUSTABLE WALL PACK, WATTAGE & CCT SELECT. WITH PHOTOCELL

MCTP Multi Color Temperature & Multi Power/Wattage (Selectable)

Customer Name: _____

Project Name: _____

Note: _____ Type: _____

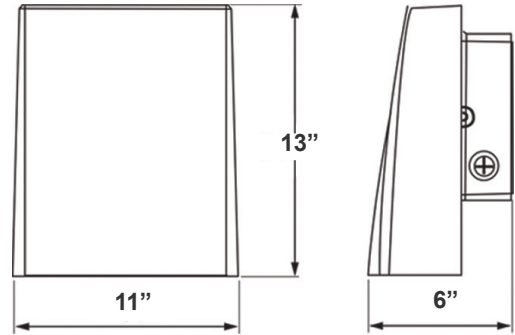

11" (W) x 13" (H) x 6" (D)
Back Box Dimensions: 8-1/2" X 8-1/2" X 3"

Ideal for general site lighting, alleys, loading docks, doorway, pathway, and parking areas. Great for use with motion sensors or another instant on/off controls.

Features

- High Light Transmittance, Anti-UV and Fire Resistant PC Lens
- Four 1/2" Knockouts: 1 Top, 1 on Each Side, 1 Back
- Die-Cast Aluminum With Powder Coat Finish (Dark Bronze)
- 7-Year Warranty
- Multi CCT and Power (Switches are inside fixture)

Technical Specifications

Electrical:

- Voltage: 120-277VAC 60Hz
- Wattage: 50W/80W/120W
- Power Factor: >0.95
- Efficacy: 125 LPW

Mechanical:

- Die-Cast Aluminum With Powder Coat Finish
- DC Button Photocell Included
- High Light Transmittance, Anti-UV and Fire Resistant Shatterproof PC Lens
- Light Head Can Be Adjusted From 0° to 90°
- Can Be Installed Facing Up (As An Uplight)
- Full Cutoff, Dark Sky Compliant
- Four 1/2" Knockouts: 1 Top, 1 on Each Side, 1 Back
- Operating Temperature: -4°F -104°F
- IP65, Suitable for Wet Location
- 7-Year Warranty

Lighting:

- Dimming: 0~10V Dimmable
- Multi CCT and Power (Switches are inside fixture)
- The Type II Distribution is Used For Wide Walkways, On Ramps and Entrance Roadways, As Well As Other Long, Narrow Lighting
- Total Lumens: 15000LM Max
- Color Temperatures: 3000K/ 4000K/ 5000K/ 5700K
- Color Rendering Index: CRI ≥ 80
- Beam angle: 80° x 100°
- Rated life: 70,000 Hrs

Applications:

- General site Lighting
- Alleys
- Loading docks
- Doorways
- Pathways
- Parking areas

Other Models:

- 50W | 6150LM | LWAX-MD-20-50W-MCTP-P



Photometrics: LWA-LG-50-120W-MCTP-P

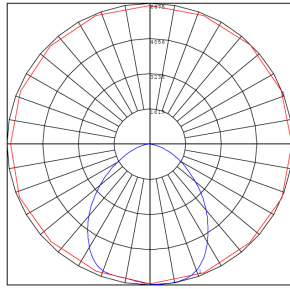
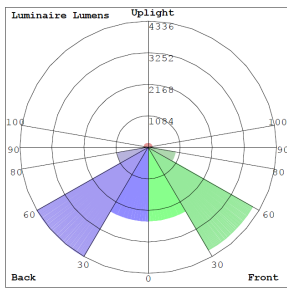

BUD Rating: B4-U3-G3

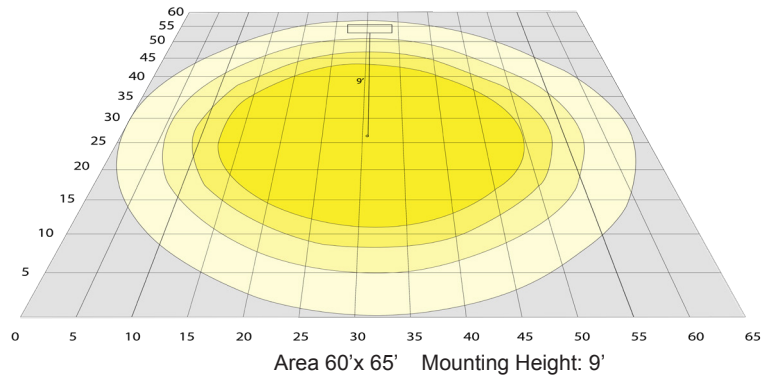

Other Views:

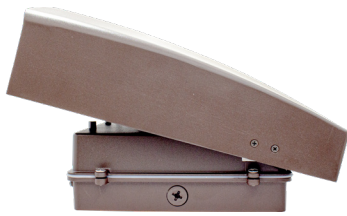

Side View

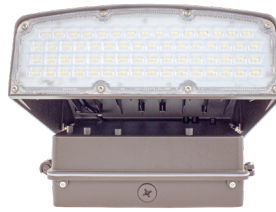

Front View

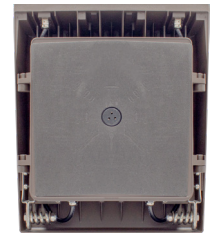

Back View

Performance Table: LWA-LG-50-120W-MCTP-P

MODEL NO.	Wattage	Voltage	Lumens	Color Temp.	BUG Rating	LPW
LWAX-LG-50-120W-MCTP-P	50W	120~277V	6250LM	3000K	B4-U3-G3	125
	80W		10000LM	4000K		
	120W		15000LM	5000K		
				5700K		

Sample Ordering

Model	Size	Min.	Max.	Wattage	Color Temp.	Photocell
LWAX	LG	50	120W	MCTP	P	

Accessories:

Blank = No Option For Accessories
LWA-SH3=SHROUD

Factory-Installed Options:

Blank = No Option For Accessories
OPT-EM-OD2INT = INTERNAL EMERGENCY BACKUP BATTERY
OPT-SEN-3MRLV-5 = PROGRAMMABLE MICROWAVE BI-LEVEL
OPT-CLR-85 = COLOR PAINT
OPT-PC-B = BUTTON
OPT-TRS-T120 = TAMPER RESISTANT SCREW
WEC-8RC = OPTIONAL REMOTE

ACCESSORIES:



LWA-SH3

FACTORY-INSTALLED OPTIONS:



OPT-EM-OD2INT



OPT-SEN-3MRLV-5



WEC-8RC



OPT-PC-B



COLOR CHART: * Choose from one of our Premium Colors with no set-up fee.

Gloss:



SILVER METALLIC
70 GLOSS
T357-GR105



SILVER METALLIC
30 GLOSS
T353-GR06



DARK RED 90
GLOSS
P009-RD02



INTERNATIONAL
ORANGE 90
GLOSS
T009-OG26



SAFETY ORANGE
90 GLOSS
T009-OG01



YELLOW 90
GLOSS
T009-YL14



YELLOW 90
GLOSS
T009-YL01

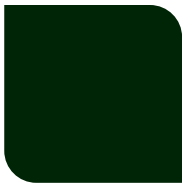

TRAFFIC GREEN
70 GLOSS
T007-GN16

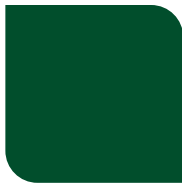

GREEN 70 GLOSS
T007-GN13

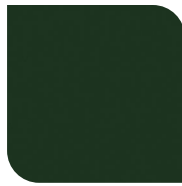

GREEN 60 GLOSS
C006-GN03



BLUE 90 GLOSS
T009-BL01



DARK BLUE 80
GLOSS
T008-BL20



RAL 8028 TERRA
BROWN 90 GLOSS
C209-BR358

Hammer:



WHITE HAMMER
T013-WH09



BEIGE HAMMER
T013-BG38



GREY HAMMER
C013-GR08

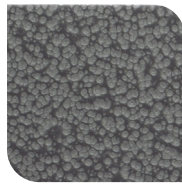

SILVER
HAMMERTONE
T064-GR05



BLACK HAMMER
T013-BK62



RED HAMMER
T013-RD15



GREEN HAMMER
T013-GN220

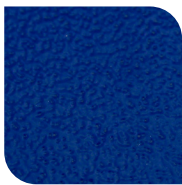

BLUE HAMMER
T013-BL468



BRONZE HAMMER
T012-BR161

Texture:



WHITE TEXTURE
C031-WH120



FLINT GRAY
TEXTURE
T243-GR522



BLACK TEXTURE
C241-BK109



RED TEXTURE
T241-RD129



BLUE TEXTURE
C241-BL544



OIL RUBBED
BRONZE TEXTURE
T291-BR251

Vein:



BLACK/WHITE
VEIN
T075-WH34



SILVER VEIN
T375-BK26

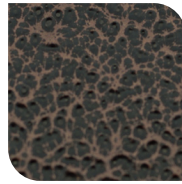

COPPER VEIN
EXTERIOR
T075-BK211



GOLD VEIN
T375-BK10



COPPER VEIN
T375-BK07

