

LTRC SERIES Commercial Lighting

LTRC-2X2-MCTP
PREMIUM CURVED INDIRECT TROFFER
MCTP Multi Color Temperature & Multi Power/Wattage (Selectable)

Customer Name: _____

Project Name: _____

Note: _____ Type: _____

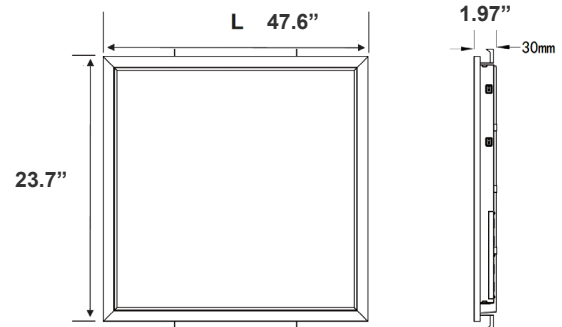
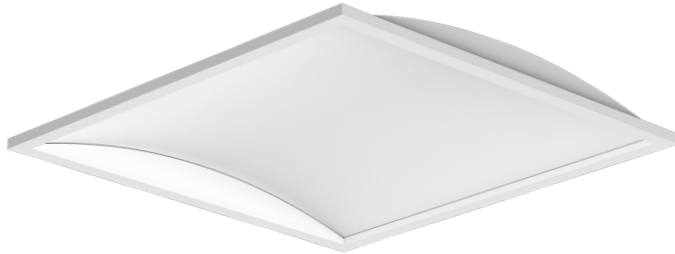

23.7 (H) X 23.7 (W) X 1.97"(D)

This indoor commercial LED Blacklit panel light is ideal for hotels, offices, retail outlets, restaurants, parking garages, storage rooms, conference rooms, education facilities, and more.

Features

- Soft and Wide Light-Emitting
- 50,000 Hours Rated Life
- No infrared rays, No Ultraviolet Radiation, No Thermal Effect
- Earthquake hooks and Suspension Hooks Pre-Installed
- No flickering, No humming, No RF interference
- Multi Color Temperature & Multi Power (Selectable Switch on Back of Fixture)

Technical Specifications

Electrical:

- Voltage: AC120V-277V 50/60Hz
- Power Factor: >0.90
- Wattage: 25W/30W/40W
- Fixture Operating Voltage: 36VDC
- Rated Input Current (mA): 420/ 337/ 253mA
- Total Harmonic Distortion: ≤ 20 %
- Efficacy: 125 LPW

Mechanical:

- White Finish
- Earthquake Hooks and Suspension Hooks pre-installed
- External driver mounted on top
- Operating Temperature: -68°F~104°F
- IP Rating: IP20 (Indoor use only)
- Rated life: 50,000 hrs

Lighting:

- Multi CCT & Multi Power (Selectable Switch On Back of Fixture)
- Dimmable: 0~10V Dimming
- Total Lumens: 5000LM
- Color Temperatures: 3500K/4000K/5000K
- Color Rendering Index: CRI ≥ 80
- 5-Year Warranty
- Beam Angle: 110°

Applications:

- Ideal for hotel, offices, retail outlets, restaurant, parking garages, storage room, conference room, education facilities and more.

Other Models:

- 50W | 6250LM | LTRC-2X4-MCTP



Photometrics: LTRC-2X2-MCTP

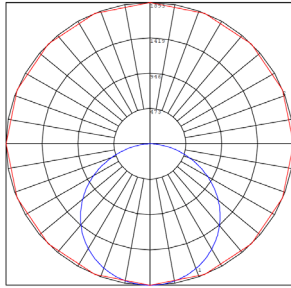
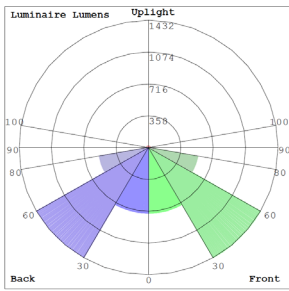

BUD Rating: B2-U2-G1

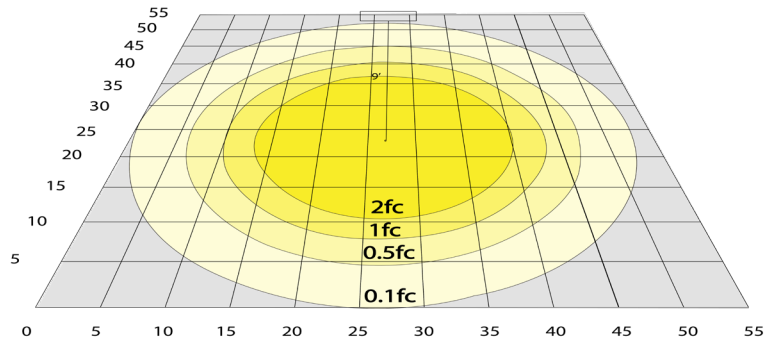

Simulation Based on 4000K Area 55'x 55' Mounting Height: 9'

Other Views:



Front View



Back View

Performance Table: LTRC-2X2-MCTP

MODEL NO.	Wattage	Voltage	Lumens	Color Temp.	BUG Rating	LPW
LTRC-2X2-MCTP	25W 30W 40W	120~277V	3150LM 3750LM 5000LM	3500K/4000K/5000K	B2-U2-G1	125

Sample Ordering

Model Size Watt/Color Temp.

LTRC - 2X2 - MCTP

Accessories:

Blank = No Option For Accessories

LPNG-RMK-2X2 = RECESSED MOUNTING FLANGE (FRAME-IN) KIT FOR INSTALLATION IN HARD SURFACES

LPNG-SRFC-2X2 = SURFACE MOUNTING KIT FOR LPNG-2X2

WEC-2CPDR = MOTION SENSOR

Factory-Installed Options:

Blank = No Option For Accessories

OPT-EM-LTRC = BATTERY MOUNT ON TOP

OPT-FWH-63 = 6FT 3-WIRE WHIP

OPT-FWH-65 = 6FT 5-WIRE WHIP

OPT-FWH-66 = 6FT 6-WIRE WHIP

OPT-SEN-2MDR-36 = PROGRAMMABLE MICROWAVE BI-LEVEL

WEC-3RC = REMOTE CONTROL

ACCESSORIES and MOUNTING KIT



LPNG-RMK-2X2

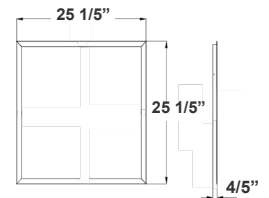

LPNG-SRFC-2X2

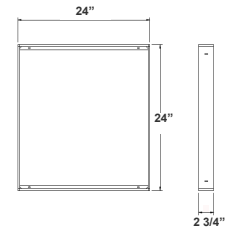

FACTORY-INSTALLED OPTIONS:



OPT-EM-LTRC



OPT-FWH-63

OPT-FWH-65

OPT-FWH-66



WEC-3RC



OPT-SEN-2MDR-36

