

LRD-TL-10W-MCT5-4S  
 4" LED ARCHITECTURAL TRIMLESS SQUARE RECESSED LIGHTS  
**MCT5** Multi Color Temperature (Selectable)

Customer Name: \_\_\_\_\_  
 Project Name: \_\_\_\_\_  
 Note: \_\_\_\_\_ | Type: \_\_\_\_\_

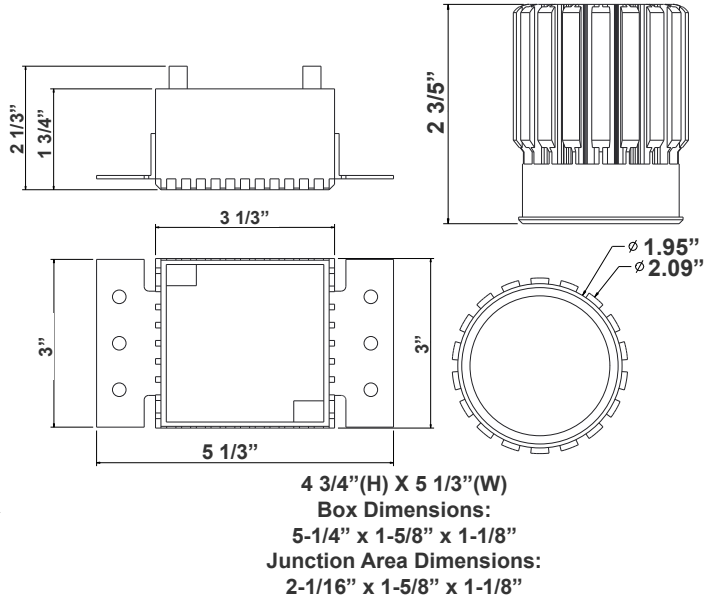

Ideal for New as well as old residential and commercial constructions.

## Features

- 4" (3-1/4" Actual) LED Timeless SQUARE Recessed Trim
- Die-Cast Aluminum With White Powder Coat Finish
- 5-Year Warranty
- Junction Box Included With Fixture

## Technical Specifications

### Electrical:

- Voltage: 120VAC
- Wattage: 10W
- Power Factor: >0.90
- Efficacy: Up To 70 LM/W

### Mechanical:

- Up to 9 AWG18 Wires
- Flanges can be adjusted for plaster up to 5/8" Thick
- Die-cast Aluminum With White Powder Coat Finish
- Clear Glass Lens
- Junction Box Rated Up to 9 AWG18 Wires
- Type IC Rated: Approved for Direct Contact With Insulation
- Operating temperature: 104°F
- Air-Tight and Type IC Rated: No Housing Required
- Damp Location Approved
- 5-Year Warranty

### Lighting:

- Multi CCT (Selectable Switch on the Back of the Driver)
- Dimming: Dimmable Down to 10% Using Standard TRIAC LED dimmer
- Total Lumens: 700LM
- Color Temperature: 2700K/3000K/3500K/4000K/5000K
- Color Rendering index: >90
- Beam Angle: 30°
- Lifespan: 50,000 Hrs.

### Applications:

- Ideal for New as well as old residential and commercial constructions.

### Other Models:

- 10W | 700LM | LRD-TL-10W-MCT5-4R-MG/WH/BK/C/HZ



# Photometrics: LRD-TL-10W-4S

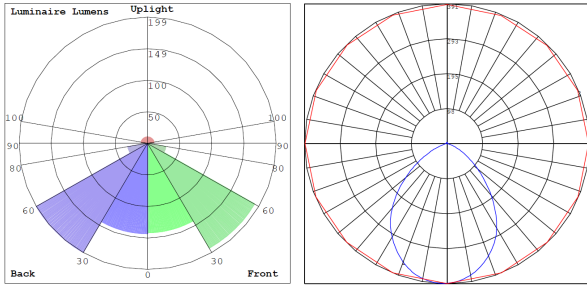

BUG Rating: B1-U2-G0

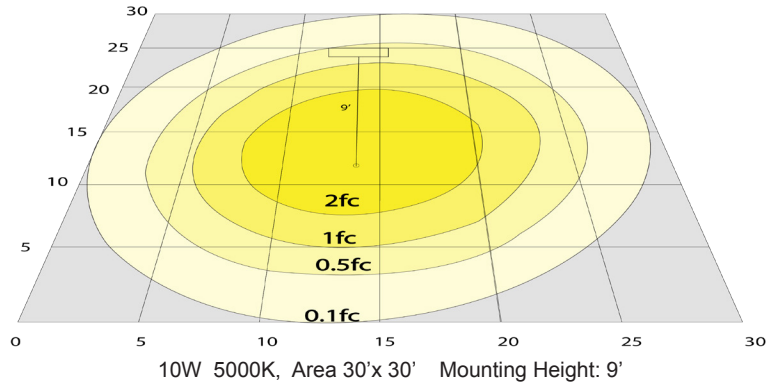

## Other Views:



LRD-TLTS4-MG



LRD-TLHS4-WH



LRD-EGN-10W-MCT5-D

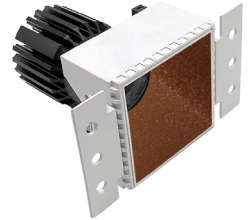

LRD-TL-10W-MCT5-4S-MG



LRD-TLTS4-WH



LRD-TLHS4-WH



LRD-EGN-10W-MCT5-D



LRD-TL-10W-MCT5-4S-WH



LRD-TLTS4-BK

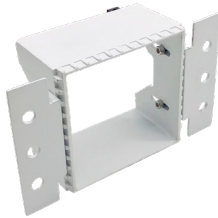

LRD-TLHS4-WH



LRD-EGN-10W-MCT5-D

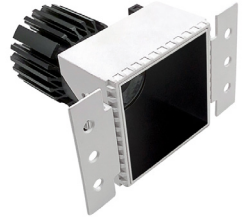

LRD-TL-10W-MCT5-4S-BK



LRD-TLTS4-C

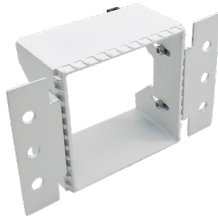

LRD-TLHS4-WH



LRD-EGN-10W-MCT5-D

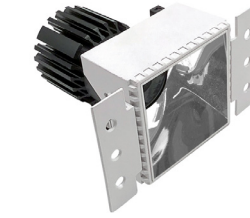

LRD-TL-10W-MCT5-4S-C



LRD-TLTS4-HZ



LRD-TLHS4-WH



LRD-EGN-10W-MCT5-D

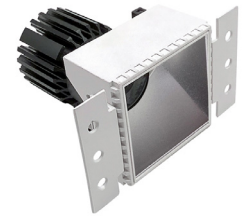

LRD-TL-10W-MCT5-4S-HZ



**Performance Table:** LRD-TL-10W

MODEL NO.	Wattage	Voltage	Lumens	Color Temp.	BUG Rating	LPW
LRD-TL-10W-MCT5-4S	10W	120V	700LM	2700K	B1-U2-G0	70
				3000K		
				3500K		
				4000K		
				5000K		

**Accessory:**

Blank = No Option For Accessories  
LRD-FGL = LRD SERES FROSTED GUASS LENS

**Accessory:**

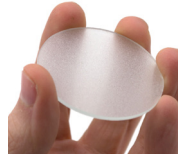

LRD-FGL

**Sample Ordering**

**Model**    **Timeless**    **Wattage**    **Color Temp.**    **Size**    **Housing**  
 -  -  -  -  -

MG = MATTE GOLD  
 WH = WHITE  
 BK = BLACK  
 C = CLEAR  
 HZ = MATTE SILVER

