

# LF4MAX SERIES Outdoor Lighting

LF4MAX-LG-150W-MCTPB-P-480V

LF4MAX SPEC SIGNATURE MAXIMUM-FEATURE ROUND-BACK FLOOD LIGHT  
**MCTP** Multi Color Temperature & Multi Power/Wattage (Selectable)

Customer Name: \_\_\_\_\_

Project Name: \_\_\_\_\_

Note: \_\_\_\_\_

Type: \_\_\_\_\_

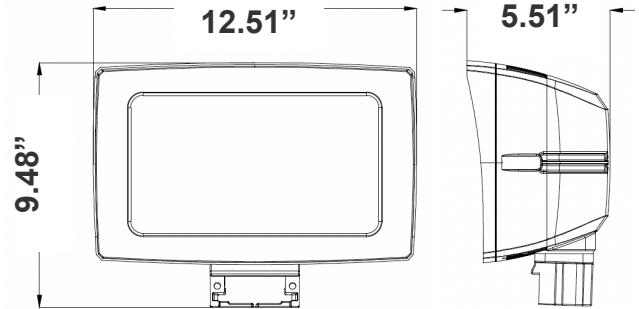

12.51"(W) x 9.48"(H) x 5.51"(D)

Round-back floodlight with U-bracket offering full control of beam angle, CCT, wattage, and photocell. Model MTP4 arriving this season.

## Features

- 7-Year Warranty
- Multi-CCT & Multi-Power - The Switches are on the Bottom of the Fixture

## Technical Specifications

### Electrical:

- Voltage: 480V AC/50~60 Hz
- Wattage: 75W/100W/150W
- Power Factor: >0.9
- Efficacy: 140LPW

### Mechanical:

- Housing: Die-cast Aluminum Housing with Powder Coat Finish
- Photocell Included (With Disconnect Switch)
- 6KV Lightning Surge Protection
- Cord Type: 6' SJTW 18/3 AWG cable
- Operating Temperature: -40°F to 104°F
- Suitable for Wet Locations
- Effective projected areas (EPA's) are:
  - Front = 0.38 square feet
  - Side = 0.30 square feet
  - Face = 1.05 square feet
- IP Rating: IP65
- 7-Year Warranty

### Lighting:

- Dimming: 0~10V Dimmable
- Multi-CCT & Multi-Power - The Switches are on the Bottom of the Fixture
- Total Lumens: 21000LM
- Color Temperature: 3000K/4000K/5000K
- Color Rendering Index:  $\geq 70$
- Adjustable Beam Angle: 135°x125°/120°x120°/90°x90°
- 70,000 Hours Rated Life

### Applications:

- Ideal for general site lighting, alleys, loading docks, doorway, pathway and parking areas.
- Replace existing HID flood lights/ wall packs



**Photometrics:** LF4MAX-LG-150 W-MCTPB-P-480V

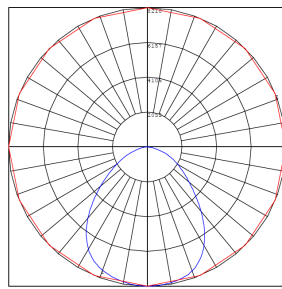
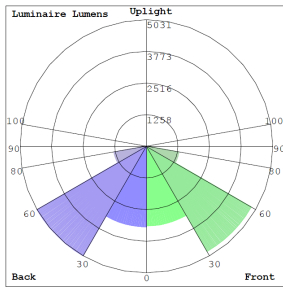

BUG Rating: B4-U0-G1

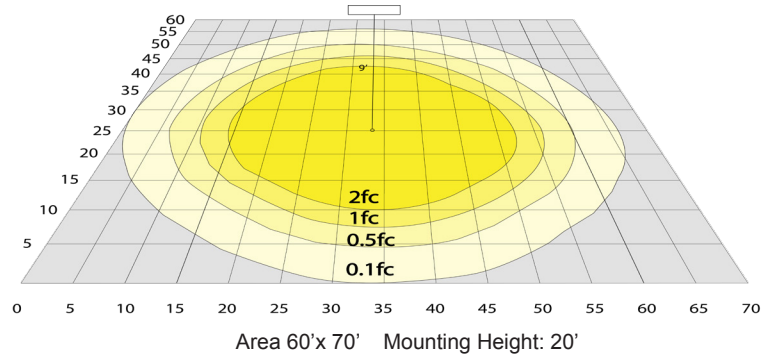

**Other Views:**

Bronze:



Side View



Front View



Back View

Black:



Side View



Front View

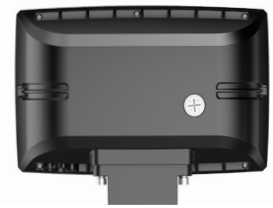

Back View

White:



Side View



Front View



Back View

**Performance Table:** LF4MAX-LG-150W-MCTPB-P-480V

MODEL NO.	Wattage	Voltage	Lumens	Color Temp.	BUG Rating	LPW
LF4MAX-LG-150W-MCTPB-P-480V	75W	480V	10500LM	3000K	B4-U0-G1	140
	100W		14000LM	4000K		
	150W		21000LM	5000K		

**Sample Ordering**

Model	Size	Max.Wattage	Color	Temp.	Photocell	Finishes	Voltage			
LF4MAX	-	LG	-	150W	-	MCTPB	-	P	-	480V



## Mounting Options:



**LFX-ASA**  
Adjustable Straight Arm  
3 1/3" x 7 7/8"

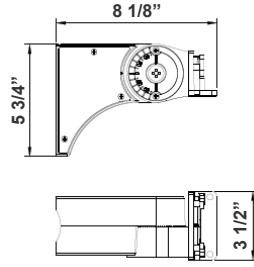

**LFX-EXT**  
Straight Arm  
3 1/3" x 6 3/4" x 4 3/8"

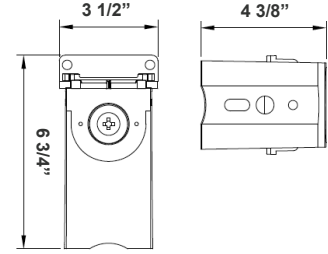

**LFX-SF**  
Slip Fitter  
3 1/3" x 7 7/8"  
For 2-3/8" OD Pole/Pipe

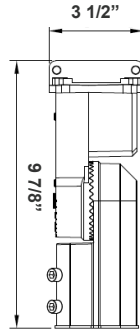

**LFX-YK**  
Yoke  
5 3/4" x 6" x 2"

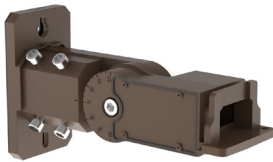
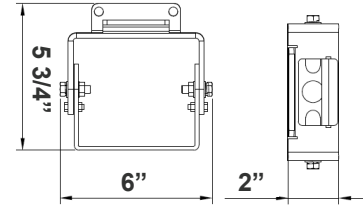

**LFX-SF + LFX-PASF**  
Pole Adapter for Slip Fitter  
6 1/8" x 3 1/4" x 3"

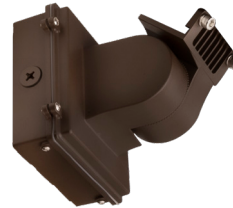
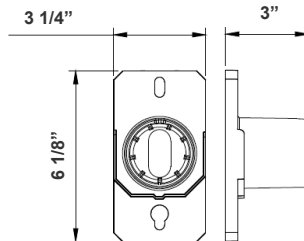

**LFX-AWB**  
Adjustable Wall Junction Box  
7 1/8" x 6 5/8" x 5 3/4"

