

GPX SERIES Outdoor Lighting

GPX-10W-SOLAR-SF
SPEC SERIES POWER & CCT- ADJUSTABLE SOLAR AREA/FLOOD LIGHT

WESTGATE
THE FUTURE IS HERE...AND IT'S QUITE BRIGHT!

Customer Name: _____
Project Name: _____
Note: _____ | Type: _____



SLIP FITTER

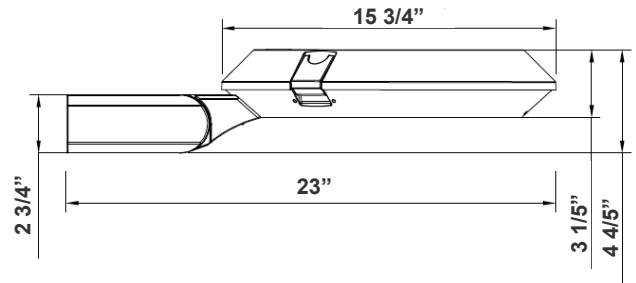

23" (W) X 4 4/5" (H)
Inside Diameter: 2 3/4"

Ideal for airports, auto dealerships, corporate offices, education, government, healthcare, industrial warehouses, municipal parking, gas stations, convenient stores, recreation and public venues, restaurants, hospitality, retail and grocery stores.

Features

- Aluminum Housing , Outdoor Powder Coated
- 7-Year Warranty

Technical Specifications

Electrical:

- Wattage: 10W
- Power Factor: 0.95
- Efficacy: 170LM/W

Battery:

- Battery Charge Time To Full Level: 6 to 12 Hours Depending On The Sunlight Quality, See The Map On Page 3
- Battery Type: LiFePO4
- Battery Life: More Than 2000 Cycles (2000/365days=5.47 Years) With Overcharge and Over-Discharge Protection
- Operation On Full Charge: 10 hrs. Depending On The Sunlight Quality, See The Map On Page 3

Mechanical:

- Aluminum Housing , Outdoor Powder Coated
- Slip fitter for 2-3/8
- Programmable Bi-Level Motion Sensor & Emergency Backup Options
- Operating Temperature: -86°F~122°F
- IP Rating: IP66, Suitable for Wet Locations
- 7-Year Warranty

Lighting:

- LED: SMD 3030
- Total Lumens: 1700LM
- Color Temperature: 3000K/4000K/5000K
- Color Rendering index: >70
- Beam Angle: Type V (150° X 150°)
- Lifespan: 70000 Hrs.

Applications:

- Ideal For Garden, Amusement Park, Residential Quater , Industrial Park And Pedestrian street.



See the remote instruction on page 3



Photometrics: GPX-10W-SOLAR-SF

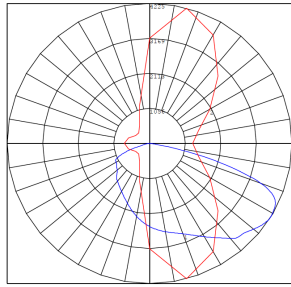

BUD Rating: B1-U1-G0

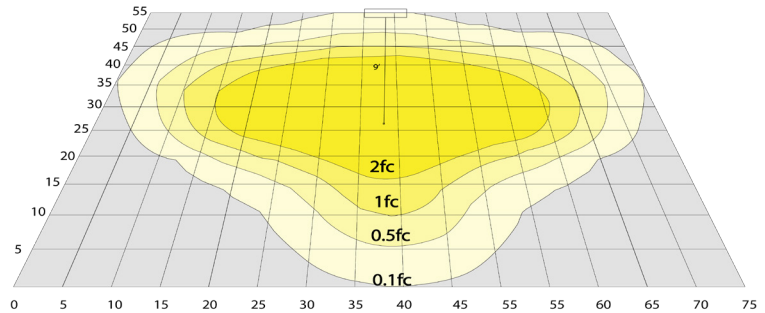

20W 5000K, Area 55'x 75' Mounting Height: 9'

Other Views:



Slip Fitter



Lens View



Top View

Performance Table: GPX-10W-SOLAR-SF

MODEL NO.	Wattage	Lumens	Color Temp.	BUG Rating	LPW
GPX-10W-SOLAR-SF	10W	1700LM	3000K 4000K 5000K	B1-U1-G0	170

Sample Ordering

Model	Watt	Battery	Mount
GPX	10W	SOLAR	SF

Factory Installed Options:

- Blank = No Option
- OPT-EM-OD2INT = INTERNAL EMERGENCY BACK UP BATTERY
- OPT-3MPC = MICROWAVE PHOTOCELL
- OPT-CLR-95(BK/GR/SR/WH) = COLOR PAINT
- OPT-SEN-3MR-3 = BI-LEVEL MICROWAVE SENSOR
- WEC-8RC = REMOTE CONTROL
- OPT-WP-480V = 480V OPTION
- OPT-GPX-LENS-TYPE2S = FACTORY-INSTALLED TYPE 2 LENS
- OPT-GPX-LENS-TYPE3S = FACTORY-INSTALLED TYPE 3 LENS
- OPT-GPX-LENS-FL = FACTORY-INSTALLED FROSTED GLASS LENS

FACTORY INSTALLED OPTIONS:



Remote Control Operation:

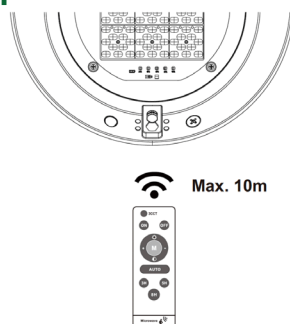

* Point the remote control at the fixture

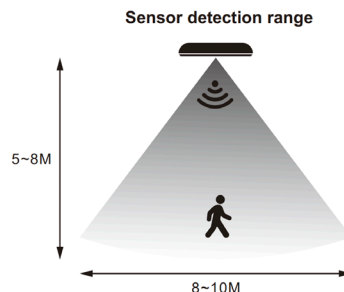

! The factory default working model is "AUTO" without motion sensor function, need to press "M" on remote control to switch to motion sensor mode.



Remote Control Operation:

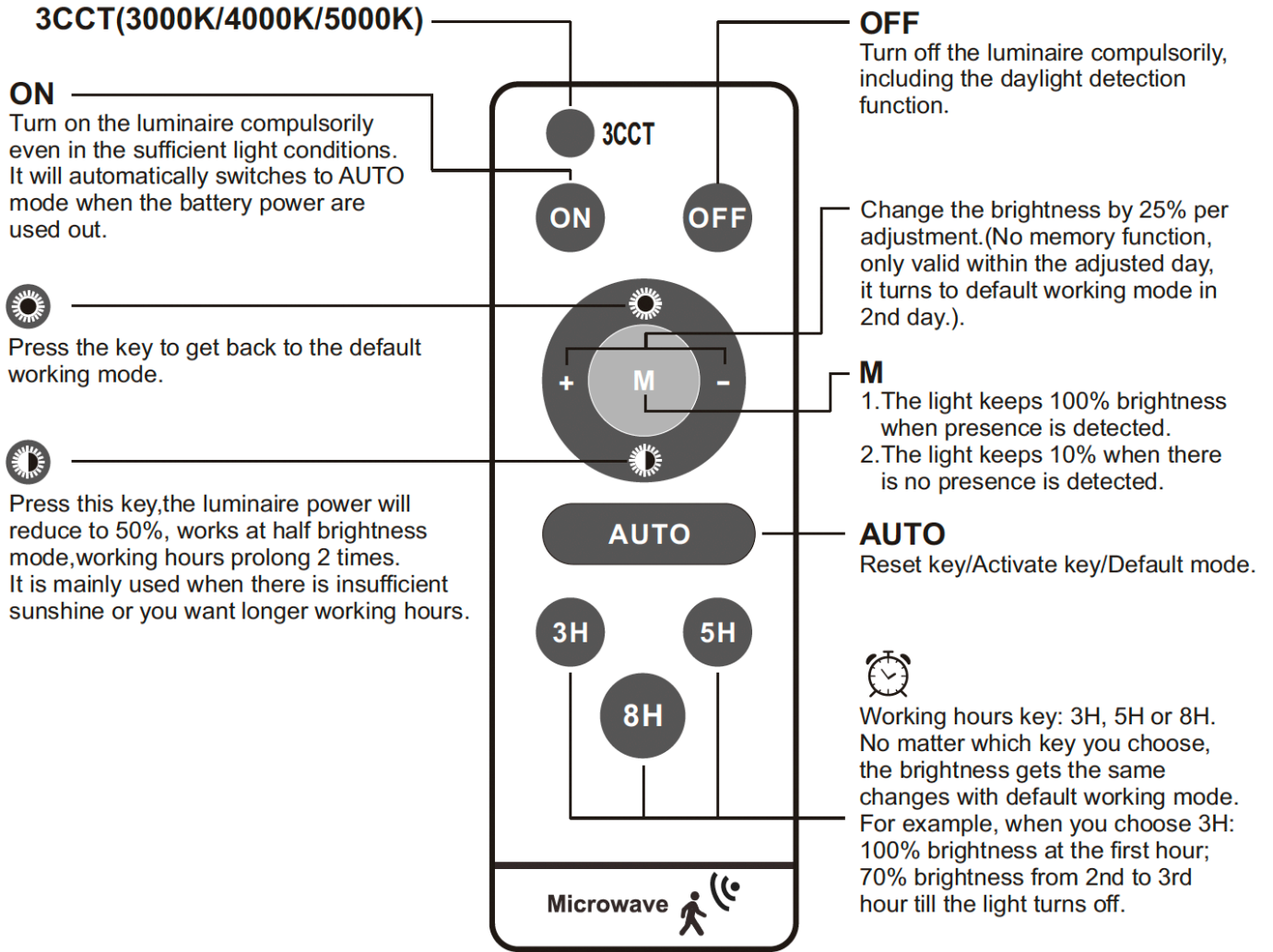

Auto /

Default Working Mode

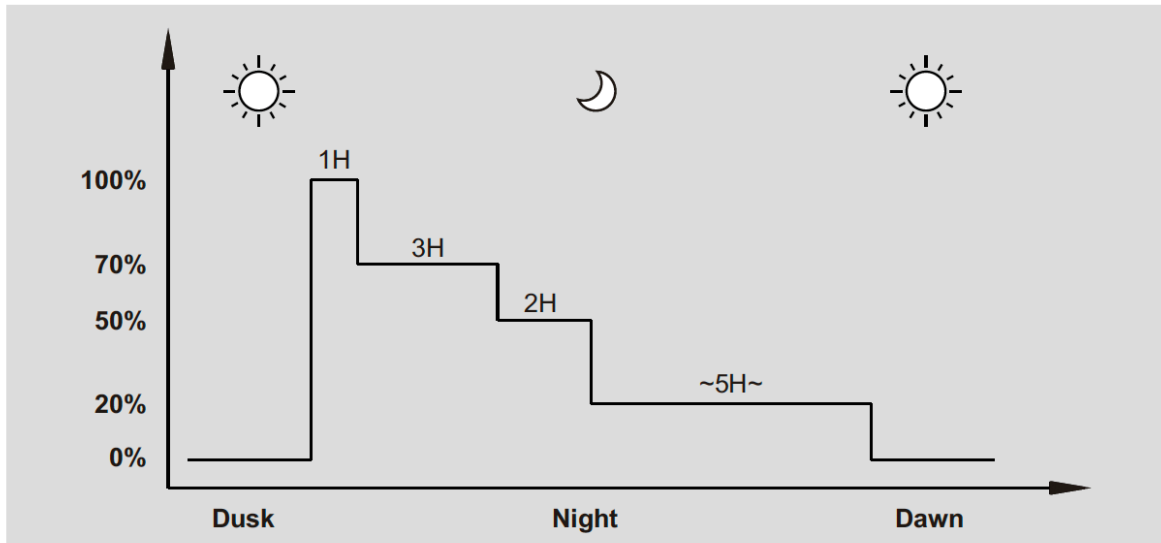



Half brightness mode

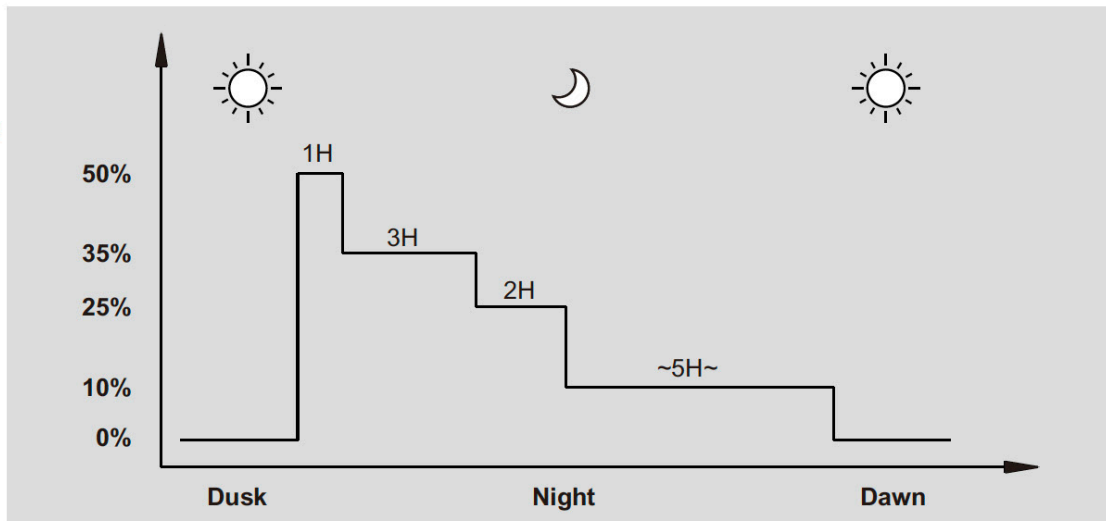

Motion detection

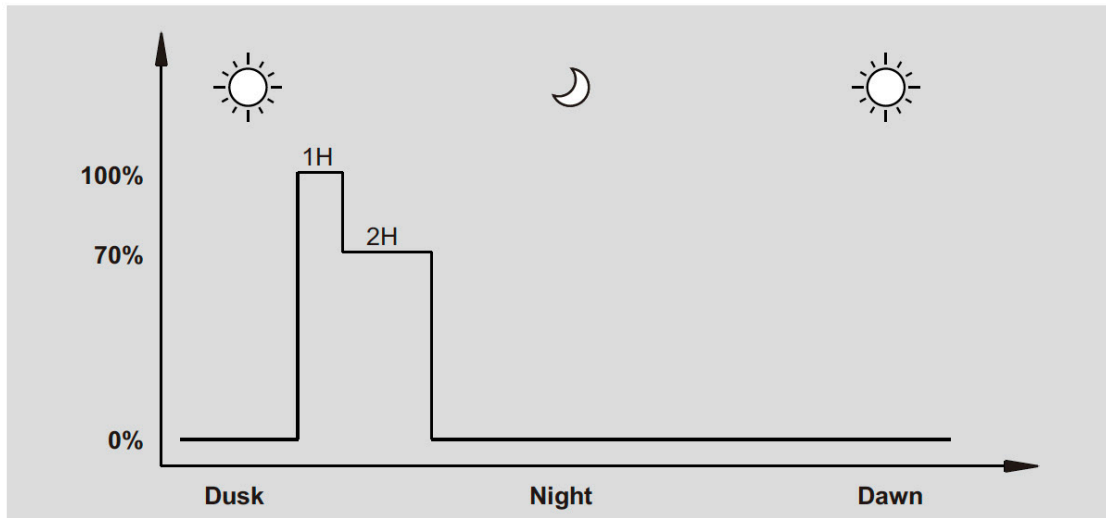
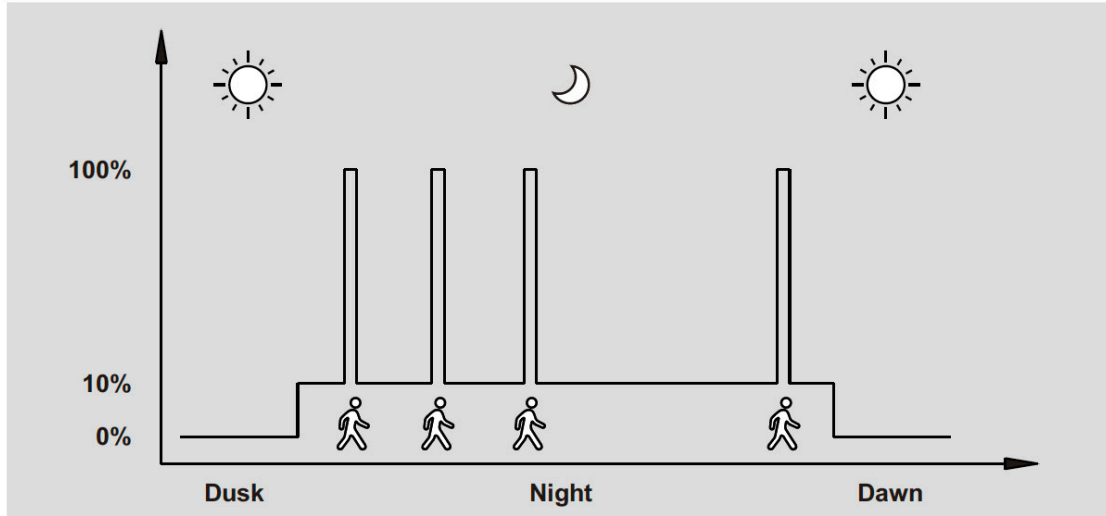

5H

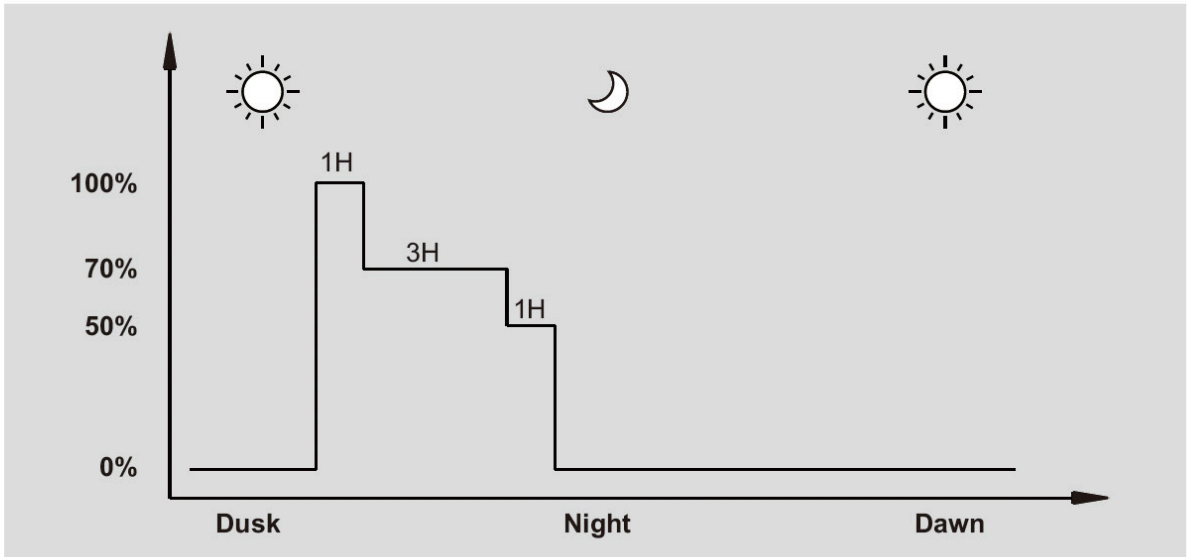

8H

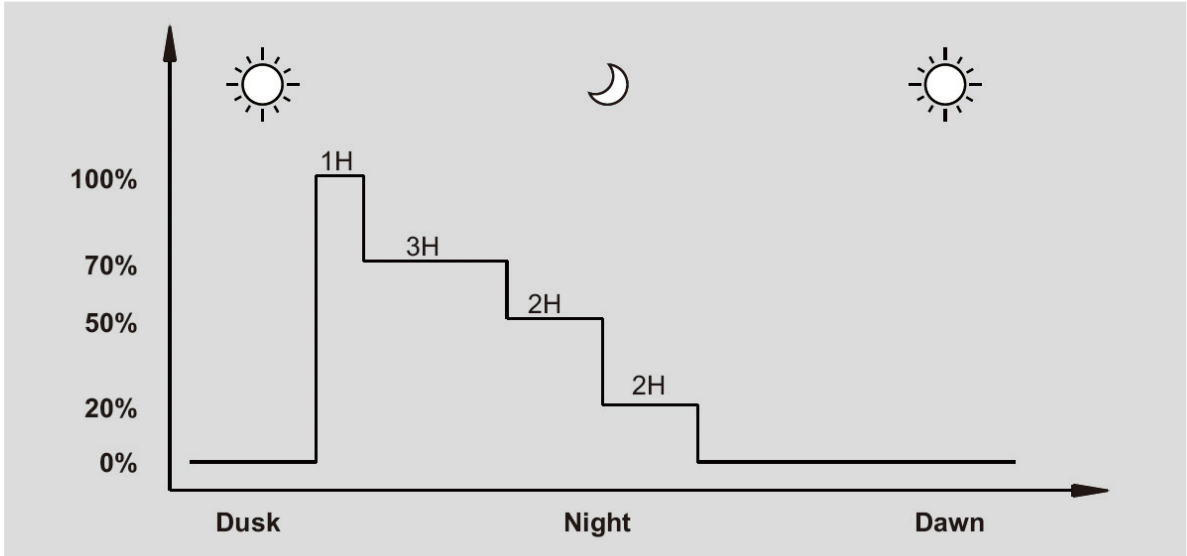

EPA Rating: DAB-SOL-A16-50W-MCT (Solar Panel Included)

Assumptions: Panel 16.5"×12.0" @ 35.0°, Luminaire face ≈ 10.0"×8.0"; Cd=1.2.

Mounting Height	EPA (sq. ft.) – combined panel + fixture
10 ft	2.02
12 ft	2.02
14 ft	2.02
16 ft	2.02
18 ft	2.02
20 ft	2.02

Note: EPA is independent of mounting height; values repeat across heights. Update will be issued if exact bell face W×H differs from placeholders.

EPA Rating: GPX-10W-SOLAR-A1

Fixture Dimensions: 15.75" W × 21" H × 3.2" D

Mounting Height	EPA (sq. ft.)
10 ft	2.76
12 ft	2.76
14 ft	2.76
16 ft	2.76
18 ft	2.76
20 ft	2.76



COLOR CHART: * Choose from one of our Premium Colors with no set-up fee.

Gloss:



Hammer:

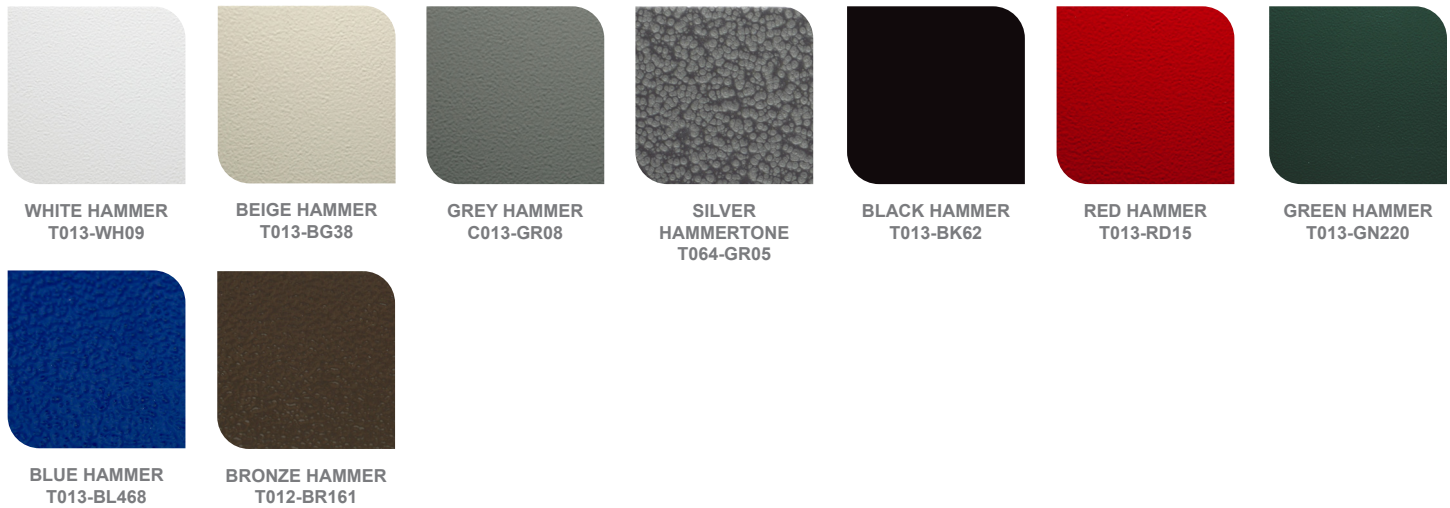

Texture:



Vein:

