

FEL-R12-MCT5

MCT5 Multi Color Temperature (Selectable)

Customer Name: _____

Project Name: _____

Note: _____ Type: _____

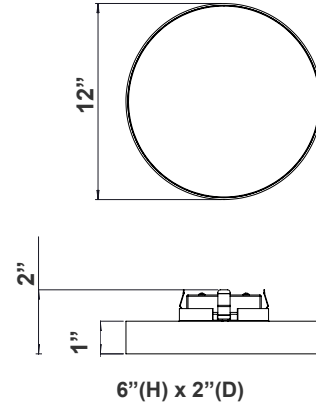

Flush Mount lighting can use in most rooms of the house, especially those where you want ambient, general light. It's especially useful for hallways, kitchens, family rooms, bathrooms, closets, and bedrooms. Also Ideal for closets, storage areas, attics, corridors, or general lighting solutions for residential and commercial applications.

Features

- Unique DOB (Driver On Board) LED Board Enclosed in Clear PC Cover for Better Wet Location Performance
- Multi CCT (Selectable Switch on LED Board Under the Lens)
- Die-cast Aluminum. Powder-Coated
- 5-Year Warranty
- 1" Deep

Technical Specifications

Electrical:

- Voltage: 120V AC
- Power Factor: >0.90
- Wattage: 25W
- Efficacy: 70 LPW

Mechanical:

- White Finish
- Die-cast Aluminum. Powder-Coated
- Maximum Ambient Temperature: 104°F
- 5-Year Warranty

Lighting:

- Lens: White translucent acrylic lens
- LED: Edge Lit LED Technology
- Dimming: TRIAC Dimming (Using Standard TRIAC LED Dimmers)
- Total Lumens: 1750LM
- Color Temperatures: 2700K/3000K/3500K/4000K/5000K
- Multi CCT (Selectable Switch on LED Board Under the Lens)
- Color Rendering Index: CRI ≥ 9
- Rated life: 50,000 hrs

Applications:

- Flush Mount lighting can use in most rooms of the house, especially those where you want ambient, general light. It's especially useful for hallways, kitchens, family rooms, bathrooms, closets, and bedrooms. Also Ideal for closets, storage areas, attics, corridors, or general lighting solutions for residential and commercial applications

Other Models:

• 10W | 700LM | FEL-R6-MCT5

• 15W | 1050LM | FEL-R8-MCT5

• 20W | 1400LM | FEL-R10-MCT5

• 30W | 2100LM | FEL-R14-MCT5



Photometrics: FEL-R12-MCT5

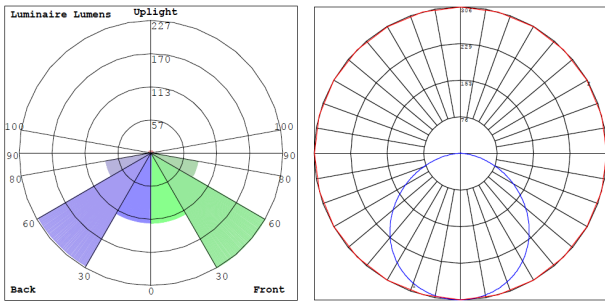

BUG Rating: B1-U1-G0

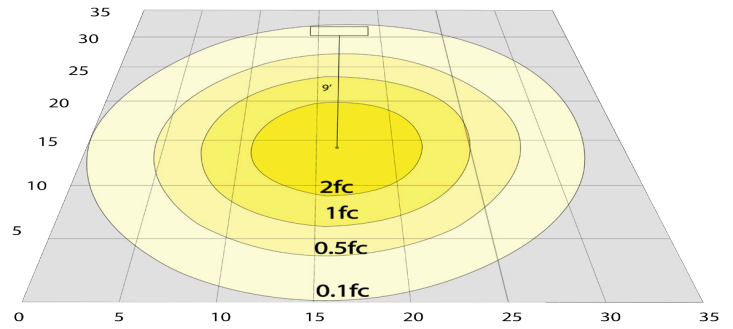

Simulation Based on 4000K Area 35'x 35' Mounting Height: 9'

Other Views:



Night View



Front View

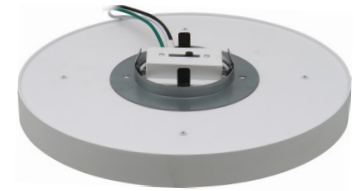

Back View

Performance Table: FEL-R12-MCT5

MODEL NO.	Wattage	Voltage	Lumens	Color Temp.	BUG Rating	LPW
FEL-R12-MCT5	25W	120V	1750LM	2700K 3000K 3500K 4000K 5000K	B0-U1-G0	70

Sample Ordering

Model	Size	Color Temp.
FEL	R12	MCT5

