

DAB SERIES Outdoor Lighting

DAB-B23-80-150W-MCTP-SR
23" DESIGNER AREA BELL LIGHT SYSTEM

MCTP Multi Color Temperature & Multi Power/Wattage (Selectable)



Ideal for airports, auto dealerships, corporate offices, education, government, healthcare, industrial warehouses, municipal parking, gas stations, convenient stores, recreation and public venues, restaurants, hospitality, retail and grocery stores.

Customer Name: _____
Project Name: _____
Note: _____ | Type: _____

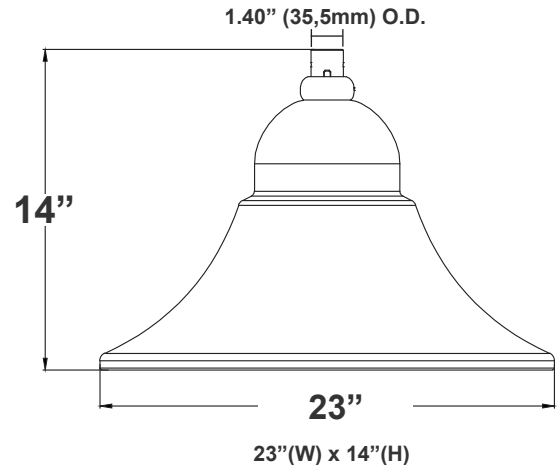

Features

- AL1060 Aluminum Hosing, Outdoor Powder Coating
- 7-Year Warranty
- Multi CCT and Power: Selectable Switch Inside Of The Fixture

Technical Specifications

Electrical:

- Voltage: 100-277V AC 50/60Hz
- Wattage: 80W/100W/150W
- Power Factor: 0.9
- THD<20%
- Efficacy: 130LM/W

Mechanical:

- AL1060 Aluminum Hosing, Outdoor Powder Coating
- Photocell Included (With Disconnect Switch)
- Twist-Lock Zhaga Socket Pre-Installed. See Motion Sensor Accessories
- EPA rating is 2.69 Square Feet
- 6' SJTW 18,3 AWG Power Cable
- 6' SJTW Dimming Cable
- Aluminum LED board: High Conductive, Waterproof, Aging Resistance, Salt eResistance
- Programmable Bi-Level Motion Sensor & Emergency Backup Options
- Operating Temperature: -40°F~104°F
- IP Rating: IP66, Suitable for Wet Locations
- 7-Year Warranty

Lighting:

- Multi CCT and Power: Selectable Switch Inside Of The Fixture
- Dimmable: 0~10V Dimming
- Lens: High Light Transmittance PC, anti-UV and Fire Resistant
- LED: Lumileds 2835
- Total Lumens: 19500LM Max.
- Color Temperature: 3000K/4000K/5000K
- Color Rendering index: >70
- Beam Angle: Type V (150° X 150°)
- Lifespan: 70000 Hrs.

Applications:

- Ideal For Garden, Amusement Park, Residential Quater , Industrial Park And Pedestrian street.

Other Models:

- 100W | 13000LM | DAB-A16-50-100W-MCTP-SR
- 100W | 13000LM | DAB-B20-50-100W-MCTP-SR



Photometrics: DAB-B23-80-150W-MCTP-SR

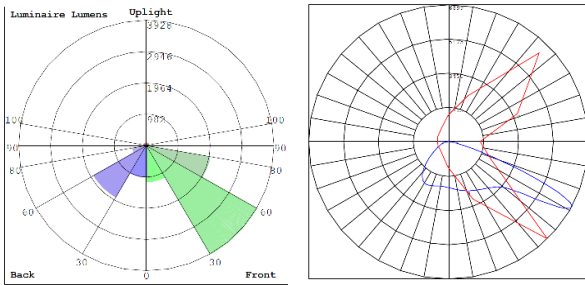

BUD Rating: B3-U0-G2

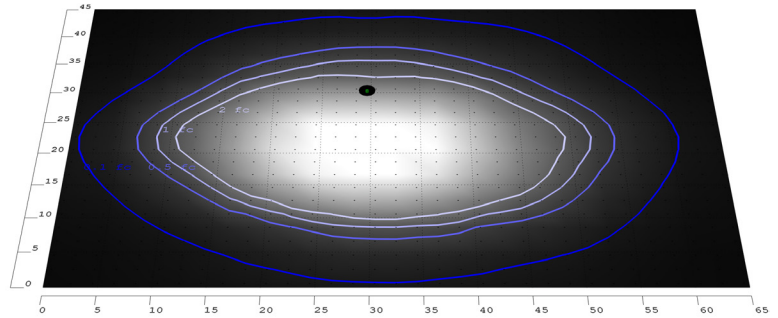

80W 5000K, Area 45'x 65' Mounting Height: 9'

Performance Table: DAB-B23-80-150W-MCTP-SR

MODEL NO.	Wattage	Voltage	Lumens	Color Temp.	BUG Rating	LPW
DAB-B23-80-150W-MCTP-SR	80W 100W 150W	120-277V	10400LM 13000LM 19500LM	3000K 4000K 5000K	B3-U0-G2	130

Sample Ordering

Model	Size	Watt	Max. Watt	Color Temp.	Sensor Ready
DAB	B23	80	150W	MCTP	SR

Accessories:

Blank = No Option
DAB-BA = DAB BELL ARM FOR MOUNTING ON SINGLE OR DOUBLE POLE ADAPTER, BLACK
DAB-PB-B = DAB DECORATIVE STRAIGHT POLE BRACKET MODEL B, FOR FLAT OR ROUND POLES, BLACK
DAB-WB-A = DAB STRAIGHT WALL BRACKET MODEL A, BLACK
DAB-PA2-1 = DAB 2in POLE ADAPTER FOR 1 BELL ARM, BLACK
DAB-PA2-2 = DAB 2in POLE ADAPTER FOR 2 BELL ARM, BLACK
DAB-PA3-1 = DAB 3in POLE ADAPTER FOR 1 BELL ARM, BLACK
DAB-PA3-2 = DAB 3in POLE ADAPTER FOR 2 BELL ARM, BLACK
DAB-PA4-1 = DAB 4in POLE ADAPTER FOR 1 BELL ARM, BLACK
DAB-PA4-2 = DAB 4in POLE ADAPTER FOR 2 BELL ARM, BLACK
DAB-WB-C = DAB BENT DECORATIVE WALL BRACKET MODEL C, BLACK
WEC-3MR-72-TLB-BK = 600W Max, ZHAGA 12-24VDC PIR SENSOR, BLACK, WITH BASE (OPTIONAL REMOTE CONTROL WEC-3RC)
WEC-3MBT-72-TLB-BK = 600W Max, ZHAGA 12-24VDC PIR SENSOR, BLACK, WITH BASE (OPTIONAL REMOTE CONTROL WEC-3RC)

Factory Installed Options:

Blank = No Option
OPT-EM-OD2INT = INTERNAL EMERGENCY BACK UP BATTERY
OPT-3MPC = MICROWAVE PHOTOCELL
OPT-CLR-95(BK/GR/SR/WH) = COLOR PAINT

ACCESSORIES:

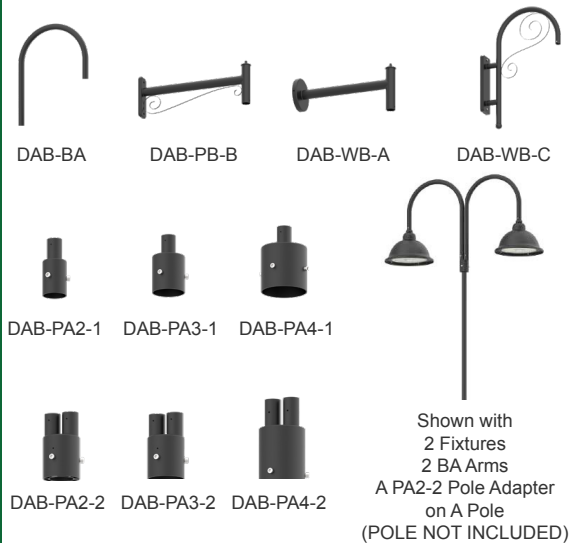

FACTORY INSTALLED OPTIONS:

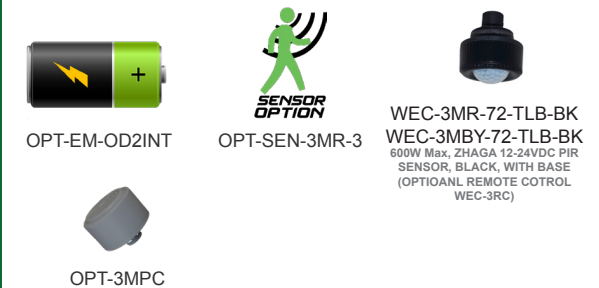

ACCESSORIES:



**DAB-BA
DAB-PA2-2**
2in POLE + 23in fixture
(double)



**DAB-BA
DAB-PA3-2**
3in POLE + 23in fixture
(double)



**DAB-BA
DAB-PA4-2**
4in POLE + 23in fixture
(double)

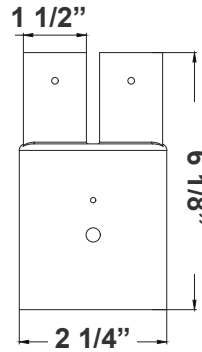

DAB-PA2-2
2 1/4"(W) x 6 1/8"(H)

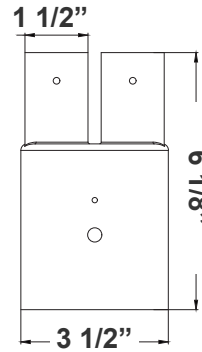

DAB-PA3-2
3 1/2"(W) x 6 1/8"(H)

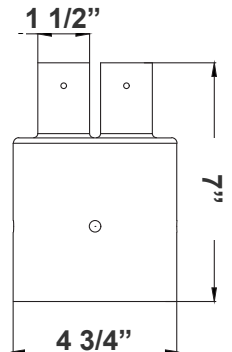

DAB-PA4-2
4 3/4"(W) x 7"(H)

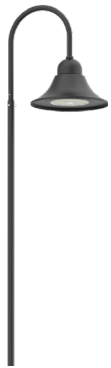

**DAB-BA
DAB-PA2-1**
2in POLE + 23in fixture



**DAB-BA
DAB-PA3-1**
3in POLE + 23in fixture



**DAB-BA
DAB-PA4-1**
4in POLE + 23in fixture

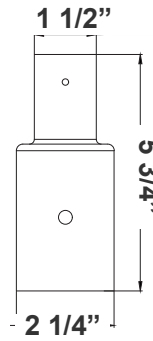

DAB-PA2-1
2 1/4"(W) x 5 3/4"(H)

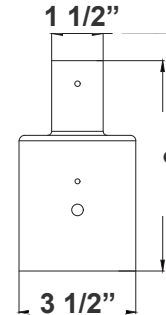

DAB-PA3-1
3 1/2"(W) x 6"(H)

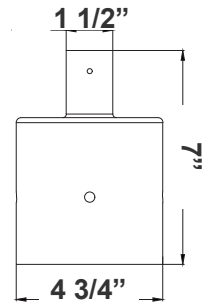

DAB-PA4-1
4 3/4"(W) x 7"(H)



DAB-BA
2in POLE + 23in fixture head



DAB-BA
3in POLE + 23in fixture head



DAB-BA
4in POLE + 23in fixture head

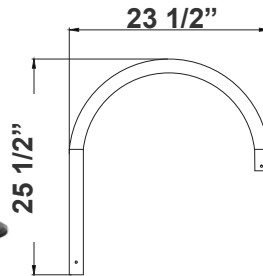

DAB-BA
23 1/2"(W) x 25 1/2"(H)



DAB-WB-A
DAB-WB-A+23in fixture
for wall

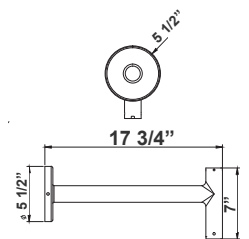

DAB-WB-A



DAB-PB-B
DAB-PB-B+23in fixture
for pole



DAB-PB-B
DAB-PB-B+23in fixture
(double)
for pole

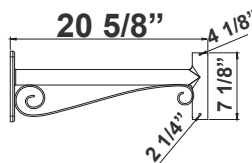
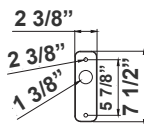

DAB-PB-B
20 85/100"(W) x 7 1/2"(H)



DAB-WB-C
DAB-WB-C+23in fixture
for wall

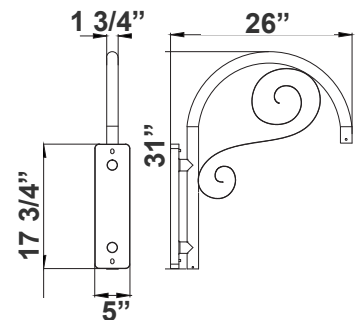



DAB-WB-C
26"(W) x 31"(H) x 5"(D)



*Decorative Arms & Poles Available Per Job Spec



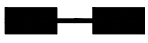

EPA Rating:

EPA of DAB Series

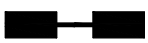
The height of the pole DAB-A16-50-100W- MCTP-SR	10'	12'	14'	16'	18'	20'
		4	4.47	4.94	5.41	5.88
	3.49	3.96	4.43	4.9	5.37	5.84
	5.6	6.07	6.54	7.01	7.48	7.95

The height of the pole DAB-B20-50-100W- MCTP-SR	10'	12'	14'	16'	18'	20'
		4.13	4.6	5.07	5.54	6.01
	3.56	4.03	5.5	5.97	6.44	6.91
	5.86	6.33	6.8	7.27	7.74	8.21

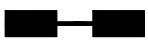
The height of the pole DAB-B23-80-150W- MCTP-SR	10'	12'	14'	16'	18'	20'
		4.54	5.01	5.48	5.95	6.42
	3.91	4.38	4.85	5.32	5.79	6.26
	6.74	7.21	7.68	8.15	8.62	9.09



COLOR CHART: * Choose from one of our Premium Colors with no set-up fee.

Gloss:



SILVER METALLIC
70 GLOSS
T357-GR105



SILVER METALLIC
30 GLOSS
T353-GR06



DARK RED 90
GLOSS
P009-RD02



INTERNATIONAL
ORANGE 90
GLOSS
T009-OG26



SAFETY ORANGE
90 GLOSS
T009-OG01



YELLOW 90
GLOSS
T009-YL14



YELLOW 90
GLOSS
T009-YL01

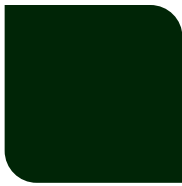

TRAFFIC GREEN
70 GLOSS
T007-GN16

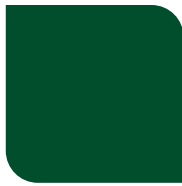

GREEN 70 GLOSS
T007-GN13



GREEN 60 GLOSS
C006-GN03



BLUE 90 GLOSS
T009-BL01



DARK BLUE 80
GLOSS
T008-BL20



RAL 8028 TERRA
BROWN 90 GLOSS
C209-BR358

Hammer:



WHITE HAMMER
T013-WH09



BEIGE HAMMER
T013-BG38



GREY HAMMER
C013-GR08

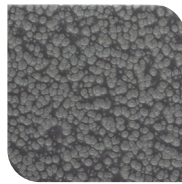

SILVER
HAMMERTONE
T064-GR05



BLACK HAMMER
T013-BK62



RED HAMMER
T013-RD15



GREEN HAMMER
T013-GN220

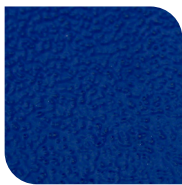

BLUE HAMMER
T013-BL468



BRONZE HAMMER
T012-BR161

Texture:



WHITE TEXTURE
C031-WH120



FLINT GRAY
TEXTURE
T243-GR522



BLACK TEXTURE
C241-BK109



RED TEXTURE
T241-RD129



BLUE TEXTURE
C241-BL544



OIL RUBBED
BRONZE TEXTURE
T291-BR251

Vein:



BLACK/WHITE
VEIN
T075-WH34



SILVER VEIN
T375-BK26

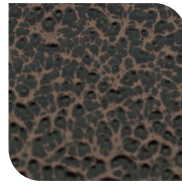

COPPER VEIN
EXTERIOR
T075-BK211



GOLD VEIN
T375-BK10



COPPER VEIN
T375-BK07

