

# CMC SERIES COMMERCIAL INDOOR LIGHTING

CMCS8-MCT-D-BK  
CMCS8-MCT-D-WH

**MCT** Multi Color Temperature (Selectable)



Shown with Suspended Cables  
(Not Incl.)



Customer Name: \_\_\_\_\_

Project Name: \_\_\_\_\_

Note: \_\_\_\_\_

Type: \_\_\_\_\_

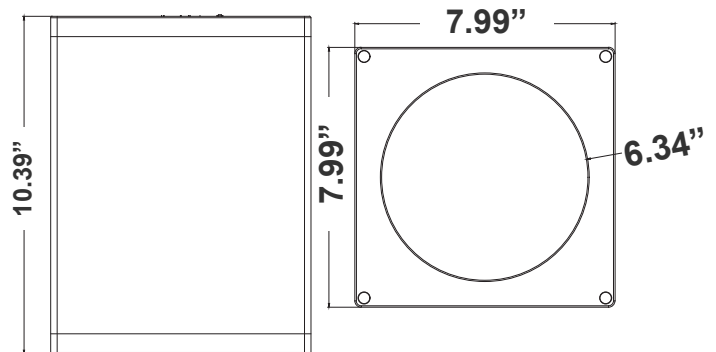

10.39"(H) X 7.99"(W)

The 8" Square Indoor Cylinder features a clean, modern design ideal for commercial and residential interiors. This fixture offers field-adjustable CCT, allowing flexibility in selecting the perfect color temperature for any space. Engineered for reliable performance and uniform illumination, it is well-suited for retail, hospitality, office, and architectural applications.

## Features

- Multi CCT: Selectable Multi-CCT & Power Switches on the back of the fixture
- 5-Year Warranty
- Aluminum Base and Glass Lens

## Technical Specifications

### Electrical:

- Voltage: 120-277V
- Power Factor: >0.90
- THD: <20%
- Wattage: 40W
- Efficacy: 80 LPW

### Mechanical:

- Aluminum Housing & Glass Lens
- Pendant Mount Only - Swivel Rod Kit Available for Suspended Mounting
- Ambient Operating Temperature: -13°F to 113°F
- IP Rating: IP40 suitable for damp locations
- 5-Year Warranty

### Lighting:

- Multi CCT: Selectable Multi-CCT & Power Switches on the back of the fixture
- Dimming: 0-10V Dimming Total Lumens: 3200LM
- Color Temperatures: 3000K/4000K/5000K
- Color Rendering Index: CRI ≥ 80
- Beam Angle: 120°
- Rated life: 50,000 hrs

### Applications:

- Ideal for commercial, retail, hospitality, and residential interiors requiring versatile architectural lighting. The 8" square indoor cylinder with adjustable CCT is well-suited for corridors, lobbies, offices, conference rooms, reception areas, and accent or general illumination. Its selectable color temperature makes it adaptable for evolving design needs and varied ambience requirements.



## Other Views:

BLACK:



Side View

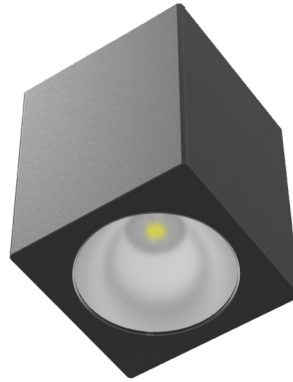

Lens View

WHITE:



Side View

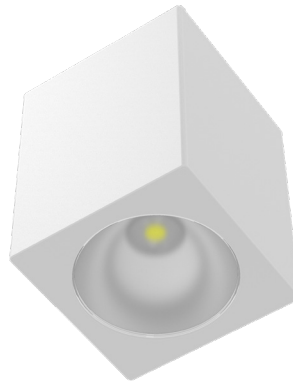

Lens View

## Performance Table: CMC8S-MCTP-DD

MODEL NO.	Wattage	Voltage	Lumens	Color Temp.	LPW
CMCS8-MCT-D-BK CMCS8-MCT-D-WH	40W	120-277V	3200LM	3000K 4000K 5000K	80

## Sample Ordering

Model Color Temp. Dimming Housing

CMCS8 - MCT - D -

BK = Black  
WH = White

### Accessories:

Blank = No Option For Accessories

- CMC-SRK-218-5C-BK = 1/2In Universal Downrod Kit With 5 Wires 2X18 H36In Bk
- CMC-SRK-218-5C-WH = 1/2In Universal Downrod Kit With 5 Wires 2X18 H36In Wh
- CMC-SRK-218-5C-BR = 1/2In Universal Downrod Kit With 5 Wires 2X18 H36In Bronze
- CMC-SRK-218-5C-SIL = 1/2In Universal Downrod Kit With 5 Wires 2X18 H36In Silver
- CMC-SRK-224-5C-BK = 1/2In Universal Downrod Kit With 5 Wires 2X24 H48In Bk
- CMC-SRK-224-5C-WH = 1/2In Universal Downrod Kit With 5 Wires 2X24 H48In Wh
- CMC-SRK-224-5C-BR = 1/2In Universal Downrod Kit With 5 Wires 2X24 H48In Bronze
- CMC-SRK-224-5C-SIL = 1/2In Universal Downrod Kit With 5 Wires 2X24 H48In Silver
- CMC-SRK-340-5C-BK = 1/2In Universal Downrod Kit With 5 Wires 3X40 H120In Bk
- CMC-SRK-340-5C-WH = 1/2In Universal Downrod Kit With 5 Wires 3X40 H120In Wh
- CMC-SRK-340-5C-BR = 1/2In Universal Downrod Kit With 5 Wires 3X40 H120In Bronze
- CMC-SRK-340-5C-SIL = 1/2In Universal Downrod Kit With 5 Wires 3X40 H120In Silver

### Factory-Installed Option:

Blank = No Option For Accessories

OPT-EM-CMC8 = Internal Emergency Backup

### ACCESSORIES:

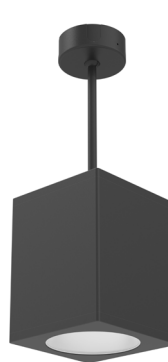

- CMC-SRK-218-5C-BK
- CMC-SRK-218-5C-WH
- CMC-SRK-218-5C-BR
- CMC-SRK-218-5C-SIL
- CMC-SRK-224-5C-BK
- CMC-SRK-224-5C-WH
- CMC-SRK-224-5C-BR
- CMC-SRK-224-5C-SIL
- CMC-SRK-340-5C-BK
- CMC-SRK-340-5C-WH
- CMC-SRK-340-5C-BR
- CMC-SRK-340-5C-SIL

### FACTORY-INSTALLED OPTION:



OPT-EM-CMC8



**Accessories:**

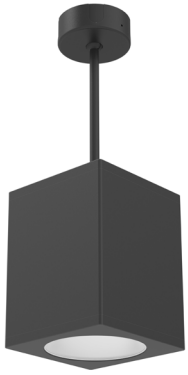

CMC-SRK-218-5C-BK  
 CMC-SRK-218-5C-WH  
 CMC-SRK-218-5C-BR  
 CMC-SRK-218-5C-SIL

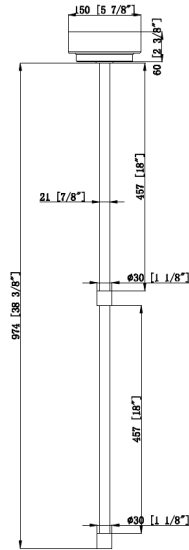

5 7/8" (W) x 38 3/8" (H)

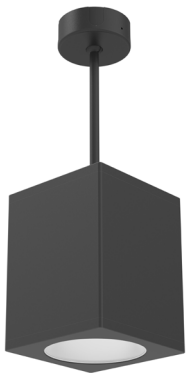

CMC-SRK-224-5C-BK  
 CMC-SRK-224-5C-WH  
 CMC-SRK-224-5C-BR  
 CMC-SRK-224-5C-SIL

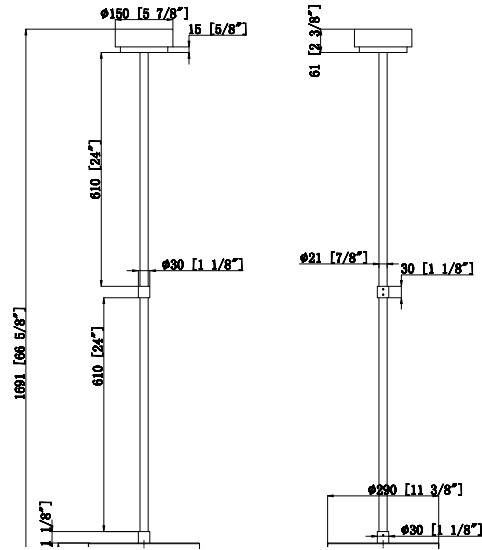

5 7/8" (W) x 66 5/8" (H)

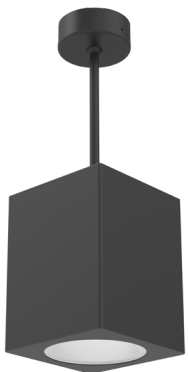

CMC-SRK-340-5C-BK  
 CMC-SRK-340-5C-WH  
 CMC-SRK-340-5C-BR  
 CMC-SRK-340-5C-SIL

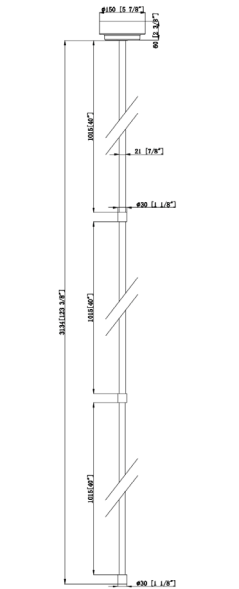

5 7/8" (W) x 123 3/8" (H)

