

IES Indoor Report

Photometric Filename: TPATPD24DLA-40WB-35K.IES

Indoor Luminaire Photometric Data

Description Information

Luminaire Name: TPATPD24DLA-40WB-35K		Lum. Catalog:	Test ID:
Lamp Name: 40W	Lamp Catalog: TPATPD24DLA-40WB-3		Test Date: 2019/07/20
Manufacture:	Shld. Ang(°):	Test Machine: GON-2000	
Test Lab:	Frequency (Hz): 60	Lamp CCT (K): 3500 Ra: 80	
Lum. Size (W*L*H): 0.603m*1.120m*0.030m		Lum. Area (m ²): 0.709	Lum. W (kg): 0.000
Test System: C, γ	Test Step: C=22.5 γ=1.0	Temp. (°C): 25	Humidity (%): 60.0

Character Parameter

Lamp Speciality Parameter		Luminaire Speciality Parameter	
Rated Flux(lm): 5103.500	Luminaire Flux(lm): 5103.496	Field Angle(10%Imax): 170.8(°)	
Rated Power(W): 40	Luminaire Efficiency: 100.00%	Down Lumens&Percent: 4961.535lm 97.22%	
Rated Voltage(V): 120	Luminaire EER(lm/W): 123.452	Up Lumens&Percent: 141.961lm 2.78%	
Tested Power(W): 41.340	Max. Candela(cd): 1668.914	S/MH: C0_a180=1.270 C90_270=1.231	
Lamps' Inside: 1	Max Cand@Ang. (°): C=180.0 γ=1.0	CIE Type: Semi-Direct	
Tested Electrics (V, A, pf): 120.2, 0.345, 0.995	Beam Angle(50%Imax): 117.1(°)	ErP φ use(120°): 3709.897lm	
Lamp Size (W*L*H): 0.603m*1.120m*0.030m	Left=-57.9°, Right=59.3°	IRF (%): 110.722	

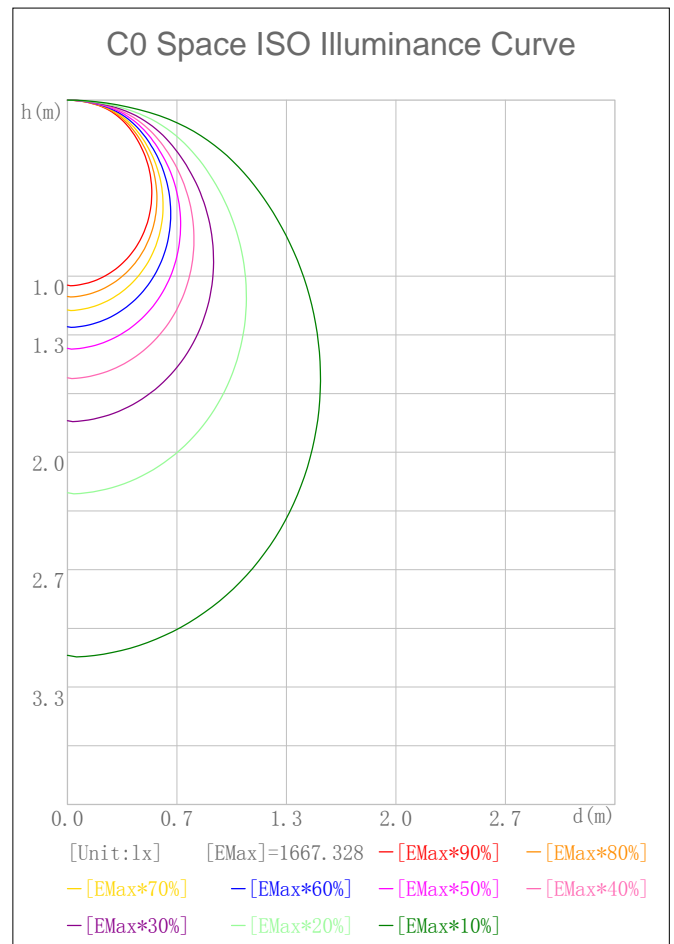
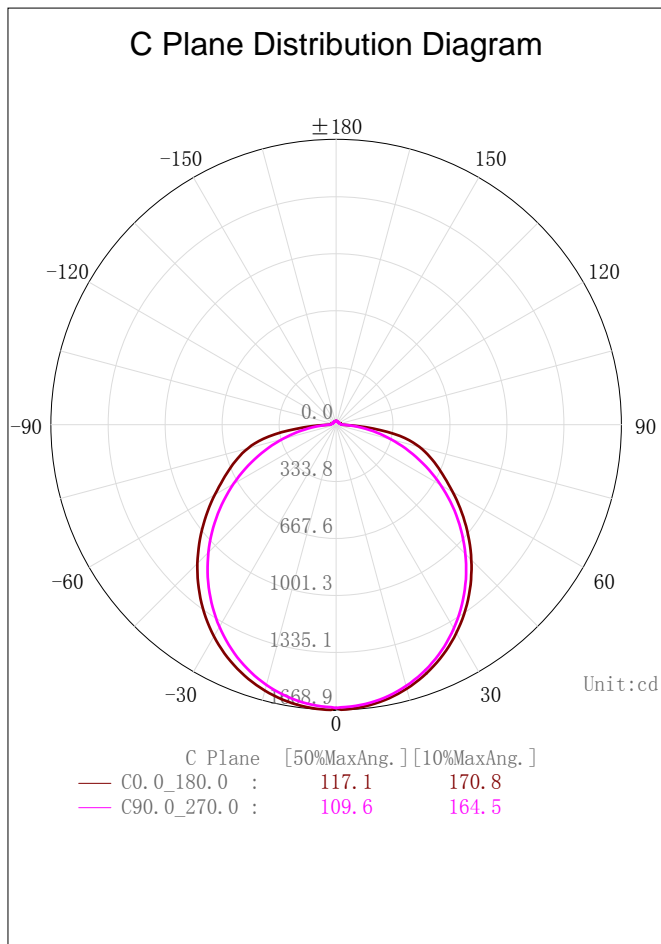

IES Indoor Report

Photometric Filename: TPATPD24DLA-40WB-35K.IES

2D Plane Light Intensity Distribution Curve

Lum. Name: TPATPD24DLA-40WB-35K	Lum. Catalog: TPATPD24DLA-40WB-3	Test ID:
Lamp Name: 40W	Lamp Catalog: TPATPD24DLA-40WB-3	Test Lab:
Manufacture:	Test Machine: GON-2000	Test Date: 2019/07/20

C Plane Distribution Diagram

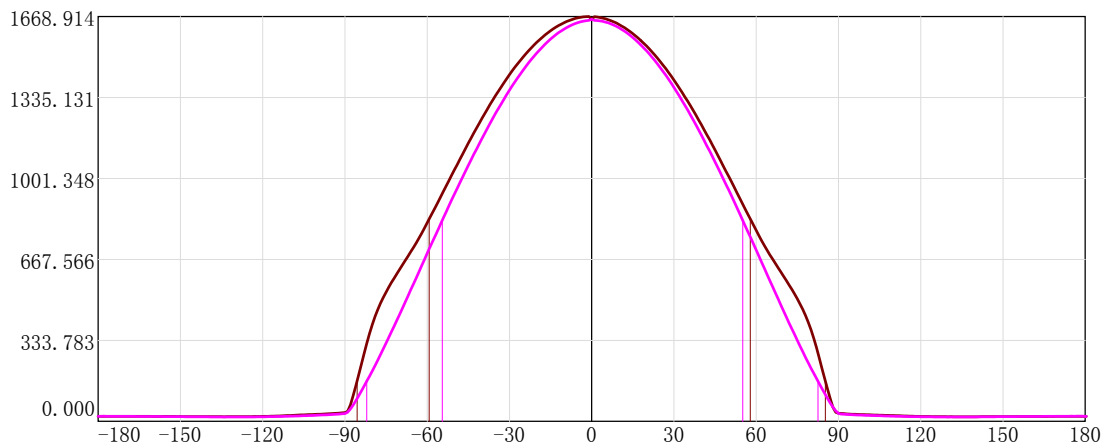
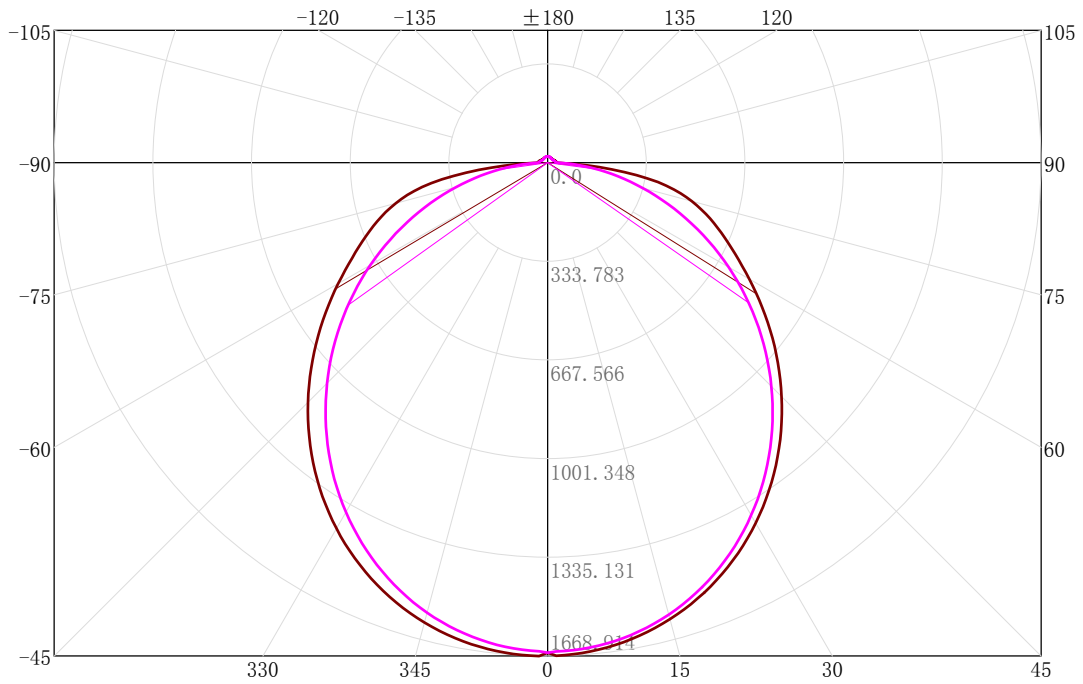

C Plane	[50%MaxAng.]	[10%MaxAng.]
— C0.0_180.0 :	117.1	170.8
— C90.0_270.0 :	109.6	164.5

Unit:cd

IES Indoor Report

Photometric Filename: TPATPD24DLA-40WB-35K.IES

3D Light Intensity Distribution Modal

Lum. Name: TPATPD24DLA-40WB-35K	Lum. Catalog:	Test ID:
Lamp Name: 40W	Lamp Catalog: TPATPD24DLA-40WB-3	Test Lab:
Manufacture:	Test Machine: GON-2000	Test Date: 2019/07/20

3D Light Intensity Distribution Modal

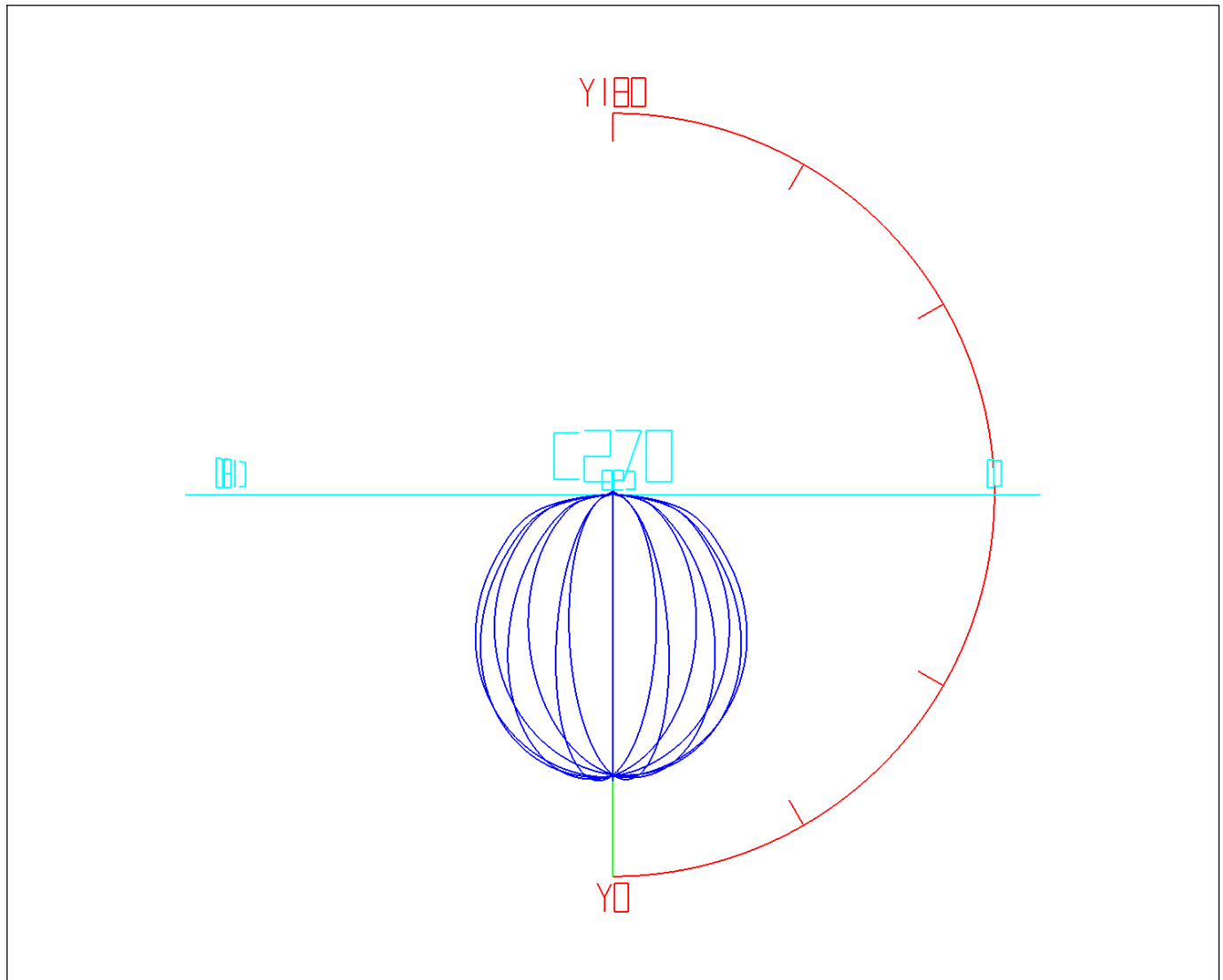

Curves: 3D Model ——— Fixture ——— Vert. HUD ——— Hori. HUD ———
View Angles: Orient:0 Tilt:0 Roll:0 Spin:0

IES Indoor Report

Photometric Filename:TPATPD24DLA-40WB-35K.IES

Zonal Flux Tabulation

Zone(γ)	Zone Flux (lm)	Sums Flux (lm)	Zone%Lamp	Sums%Lamp	Zone(γ)	Zone Flux (lm)	Sums Flux (lm)	Zone%Lamp	Sums%Lamp
0.0-1.0	1.59	1.59	0.03	0.03	47.0-48.0	83.92	2772.49	1.64	54.33
1.0-2.0	4.75	6.34	0.09	0.12	48.0-49.0	83.38	2855.87	1.63	55.96
2.0-3.0	7.91	14.25	0.16	0.28	49.0-50.0	82.74	2938.61	1.62	57.58
3.0-4.0	11.06	25.31	0.22	0.50	50.0-51.0	82.03	3020.64	1.61	59.19
4.0-5.0	14.19	39.51	0.28	0.77	51.0-52.0	81.21	3101.84	1.59	60.78
5.0-6.0	17.31	56.81	0.34	1.11	52.0-53.0	80.29	3182.14	1.57	62.35
6.0-7.0	20.40	77.21	0.40	1.51	53.0-54.0	79.31	3261.45	1.55	63.91
7.0-8.0	23.45	100.66	0.46	1.97	54.0-55.0	78.21	3339.66	1.53	65.44
8.0-9.0	26.48	127.14	0.52	2.49	55.0-56.0	77.04	3416.70	1.51	66.95
9.0-10.0	29.47	156.61	0.58	3.07	56.0-57.0	75.80	3492.50	1.49	68.43
10.0-11.0	32.41	189.03	0.64	3.70	57.0-58.0	74.49	3566.99	1.46	69.89
11.0-12.0	35.31	224.34	0.69	4.40	58.0-59.0	73.11	3640.10	1.43	71.33
12.0-13.0	38.16	262.50	0.75	5.14	59.0-60.0	71.68	3711.78	1.40	72.73
13.0-14.0	40.96	303.46	0.80	5.95	60.0-61.0	70.17	3781.95	1.37	74.10
14.0-15.0	43.70	347.16	0.86	6.80	61.0-62.0	68.60	3850.55	1.34	75.45
15.0-16.0	46.37	393.53	0.91	7.71	62.0-63.0	67.00	3917.55	1.31	76.76
16.0-17.0	48.99	442.52	0.96	8.67	63.0-64.0	65.36	3982.91	1.28	78.04
17.0-18.0	51.53	494.04	1.01	9.68	64.0-65.0	63.70	4046.61	1.25	79.29
18.0-19.0	54.00	548.04	1.06	10.74	65.0-66.0	62.00	4108.60	1.21	80.51
19.0-20.0	56.39	604.43	1.10	11.84	66.0-67.0	60.27	4168.87	1.18	81.69
20.0-21.0	58.70	663.13	1.15	12.99	67.0-68.0	58.53	4227.40	1.15	82.83
21.0-22.0	60.93	724.06	1.19	14.19	68.0-69.0	56.76	4284.16	1.11	83.95
22.0-23.0	63.09	787.15	1.24	15.42	69.0-70.0	54.97	4339.13	1.08	85.02
23.0-24.0	65.14	852.29	1.28	16.70	70.0-71.0	53.17	4392.30	1.04	86.06
24.0-25.0	67.11	919.40	1.31	18.02	71.0-72.0	51.33	4443.63	1.01	87.07
25.0-26.0	68.99	988.39	1.35	19.37	72.0-73.0	49.47	4493.11	0.97	88.04
26.0-27.0	70.77	1059.16	1.39	20.75	73.0-74.0	47.59	4540.70	0.93	88.97
27.0-28.0	72.45	1131.61	1.42	22.17	74.0-75.0	45.65	4586.34	0.89	89.87
28.0-29.0	74.04	1205.65	1.45	23.62	75.0-76.0	43.66	4630.01	0.86	90.72
29.0-30.0	75.52	1281.17	1.48	25.10	76.0-77.0	41.62	4671.63	0.82	91.54
30.0-31.0	76.90	1358.07	1.51	26.61	77.0-78.0	39.48	4711.10	0.77	92.31
31.0-32.0	78.17	1436.24	1.53	28.14	78.0-79.0	37.21	4748.31	0.73	93.04
32.0-33.0	79.34	1515.59	1.55	29.70	79.0-80.0	34.79	4783.10	0.68	93.72
33.0-34.0	80.41	1596.00	1.58	31.27	80.0-81.0	32.20	4815.31	0.63	94.35
34.0-35.0	81.36	1677.36	1.59	32.87	81.0-82.0	29.40	4844.70	0.58	94.93
35.0-36.0	82.21	1759.57	1.61	34.48	82.0-83.0	26.34	4871.04	0.52	95.45
36.0-37.0	82.95	1842.52	1.63	36.10	83.0-84.0	23.06	4894.10	0.45	95.90
37.0-38.0	83.57	1926.09	1.64	37.74	84.0-85.0	19.63	4913.73	0.38	96.28
38.0-39.0	84.08	2010.17	1.65	39.39	85.0-86.0	16.06	4929.79	0.31	96.60
39.0-40.0	84.50	2094.67	1.66	41.04	86.0-87.0	12.48	4942.27	0.24	96.84
40.0-41.0	84.81	2179.48	1.66	42.71	87.0-88.0	9.02	4951.29	0.18	97.02
41.0-42.0	84.99	2264.47	1.67	44.37	88.0-89.0	6.01	4957.30	0.12	97.14
42.0-43.0	85.08	2349.55	1.67	46.04	89.0-90.0	4.24	4961.54	0.08	97.22
43.0-44.0	85.05	2434.60	1.67	47.70	90.0-91.0	3.67	4965.20	0.07	97.29
44.0-45.0	84.92	2519.52	1.66	49.37	91.0-92.0	3.51	4968.71	0.07	97.36
45.0-46.0	84.69	2604.21	1.66	51.03	92.0-93.0	3.42	4972.13	0.07	97.43
46.0-47.0	84.36	2688.57	1.65	52.68	93.0-94.0	3.34	4975.47	0.07	97.49

IES Indoor Report

Photometric Filename:TPATPD24DLA-40WB-35K.IES

Zonal Flux Tabulation - (Cont.)

Zone(γ)	Zone Flux (lm)	Sums Flux (lm)	Zone%Lamp	Sums%Lamp	Zone(γ)	Zone Flux (lm)	Sums Flux (lm)	Zone%Lamp	Sums%Lamp
94.0-95.0	3.26	4978.73	0.06	97.56	141.0-142.0	1.31	5076.77	0.03	99.48
95.0-96.0	3.19	4981.93	0.06	97.62	142.0-143.0	1.29	5078.06	0.03	99.50
96.0-97.0	3.13	4985.05	0.06	97.68	143.0-144.0	1.26	5079.32	0.02	99.53
97.0-98.0	3.06	4988.12	0.06	97.74	144.0-145.0	1.23	5080.55	0.02	99.55
98.0-99.0	3.01	4991.12	0.06	97.80	145.0-146.0	1.21	5081.76	0.02	99.57
99.0-100.0	2.95	4994.07	0.06	97.86	146.0-147.0	1.18	5082.95	0.02	99.60
100.0-101.0	2.89	4996.96	0.06	97.91	147.0-148.0	1.16	5084.10	0.02	99.62
101.0-102.0	2.84	4999.80	0.06	97.97	148.0-149.0	1.13	5085.23	0.02	99.64
102.0-103.0	2.78	5002.58	0.05	98.02	149.0-150.0	1.10	5086.33	0.02	99.66
103.0-104.0	2.73	5005.31	0.05	98.08	150.0-151.0	1.07	5087.40	0.02	99.68
104.0-105.0	2.68	5007.99	0.05	98.13	151.0-152.0	1.04	5088.44	0.02	99.70
105.0-106.0	2.63	5010.62	0.05	98.18	152.0-153.0	1.01	5089.45	0.02	99.72
106.0-107.0	2.57	5013.19	0.05	98.23	153.0-154.0	0.98	5090.43	0.02	99.74
107.0-108.0	2.52	5015.71	0.05	98.28	154.0-155.0	0.95	5091.37	0.02	99.76
108.0-109.0	2.47	5018.18	0.05	98.33	155.0-156.0	0.91	5092.29	0.02	99.78
109.0-110.0	2.41	5020.59	0.05	98.38	156.0-157.0	0.88	5093.17	0.02	99.80
110.0-111.0	2.36	5022.95	0.05	98.42	157.0-158.0	0.85	5094.02	0.02	99.81
111.0-112.0	2.30	5025.25	0.05	98.47	158.0-159.0	0.82	5094.84	0.02	99.83
112.0-113.0	2.25	5027.51	0.04	98.51	159.0-160.0	0.78	5095.62	0.02	99.85
113.0-114.0	2.20	5029.70	0.04	98.55	160.0-161.0	0.75	5096.37	0.01	99.86
114.0-115.0	2.15	5031.85	0.04	98.60	161.0-162.0	0.71	5097.08	0.01	99.87
115.0-116.0	2.10	5033.95	0.04	98.64	162.0-163.0	0.68	5097.76	0.01	99.89
116.0-117.0	2.05	5036.00	0.04	98.68	163.0-164.0	0.64	5098.41	0.01	99.90
117.0-118.0	2.01	5038.01	0.04	98.72	164.0-165.0	0.61	5099.01	0.01	99.91
118.0-119.0	1.97	5039.98	0.04	98.76	165.0-166.0	0.57	5099.58	0.01	99.92
119.0-120.0	1.93	5041.91	0.04	98.79	166.0-167.0	0.53	5100.12	0.01	99.93
120.0-121.0	1.89	5043.81	0.04	98.83	167.0-168.0	0.49	5100.61	0.01	99.94
121.0-122.0	1.86	5045.66	0.04	98.87	168.0-169.0	0.46	5101.07	0.01	99.95
122.0-123.0	1.82	5047.48	0.04	98.90	169.0-170.0	0.42	5101.48	0.01	99.96
123.0-124.0	1.79	5049.27	0.04	98.94	170.0-171.0	0.38	5101.86	0.01	99.97
124.0-125.0	1.76	5051.03	0.03	98.97	171.0-172.0	0.34	5102.21	0.01	99.97
125.0-126.0	1.73	5052.75	0.03	99.01	172.0-173.0	0.30	5102.51	0.01	99.98
126.0-127.0	1.70	5054.45	0.03	99.04	173.0-174.0	0.26	5102.77	0.01	99.99
127.0-128.0	1.67	5056.12	0.03	99.07	174.0-175.0	0.22	5102.99	0.00	99.99
128.0-129.0	1.64	5057.76	0.03	99.10	175.0-176.0	0.18	5103.17	0.00	99.99
129.0-130.0	1.62	5059.38	0.03	99.14	176.0-177.0	0.14	5103.31	0.00	100.00
130.0-131.0	1.59	5060.97	0.03	99.17	177.0-178.0	0.10	5103.41	0.00	100.00
131.0-132.0	1.56	5062.53	0.03	99.20	178.0-179.0	0.06	5103.48	0.00	100.00
132.0-133.0	1.54	5064.07	0.03	99.23	179.0-180.0	0.02	5103.50	0.00	100.00
133.0-134.0	1.51	5065.58	0.03	99.26					
134.0-135.0	1.49	5067.07	0.03	99.29					
135.0-136.0	1.46	5068.53	0.03	99.31					
136.0-137.0	1.44	5069.96	0.03	99.34					
137.0-138.0	1.41	5071.37	0.03	99.37					
138.0-139.0	1.39	5072.76	0.03	99.40					
139.0-140.0	1.36	5074.12	0.03	99.42					
140.0-141.0	1.34	5075.46	0.03	99.45					

IES Indoor Report

Photometric Filename: TPATPD24DLA-40WB-35K.IES

Rectangle ISO Lighting Intensity Diagram

Lum. Name: TPATPD24DLA-40WB-35K	Lum. Catalog:	Test ID:
Lamp Name: 40W	Lamp Catalog: TPATPD24DLA-40WB-3	Test Lab:
Manufacture:	Test Machine: GON-2000	Test Date: 2019/07/20

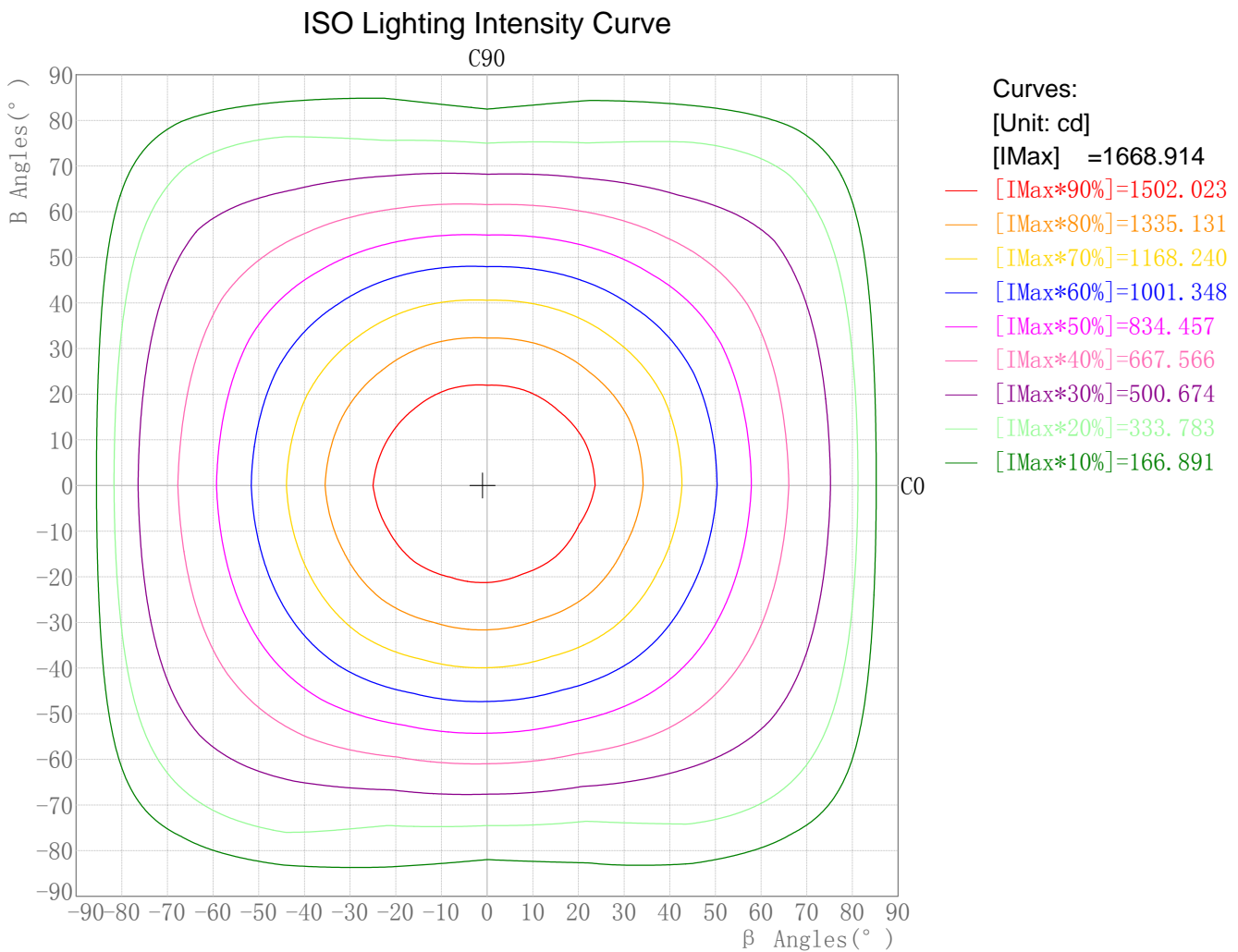

IES Indoor Report

Photometric Filename: TPATPD24DLA-40WB-35K.IES

Plane ISO-Illuminance Diagram

Lum. Name: TPATPD24DLA-40WB-35K	Lum. Catalog:	Test ID:
Lamp Name: 40W	Lamp Catalog: TPATPD24DLA-40WB-3	Test Lab:
Manufacture:	Test Machine: GON-2000	Test Date: 2019/07/20

Plane ISO-Illuminance Curve

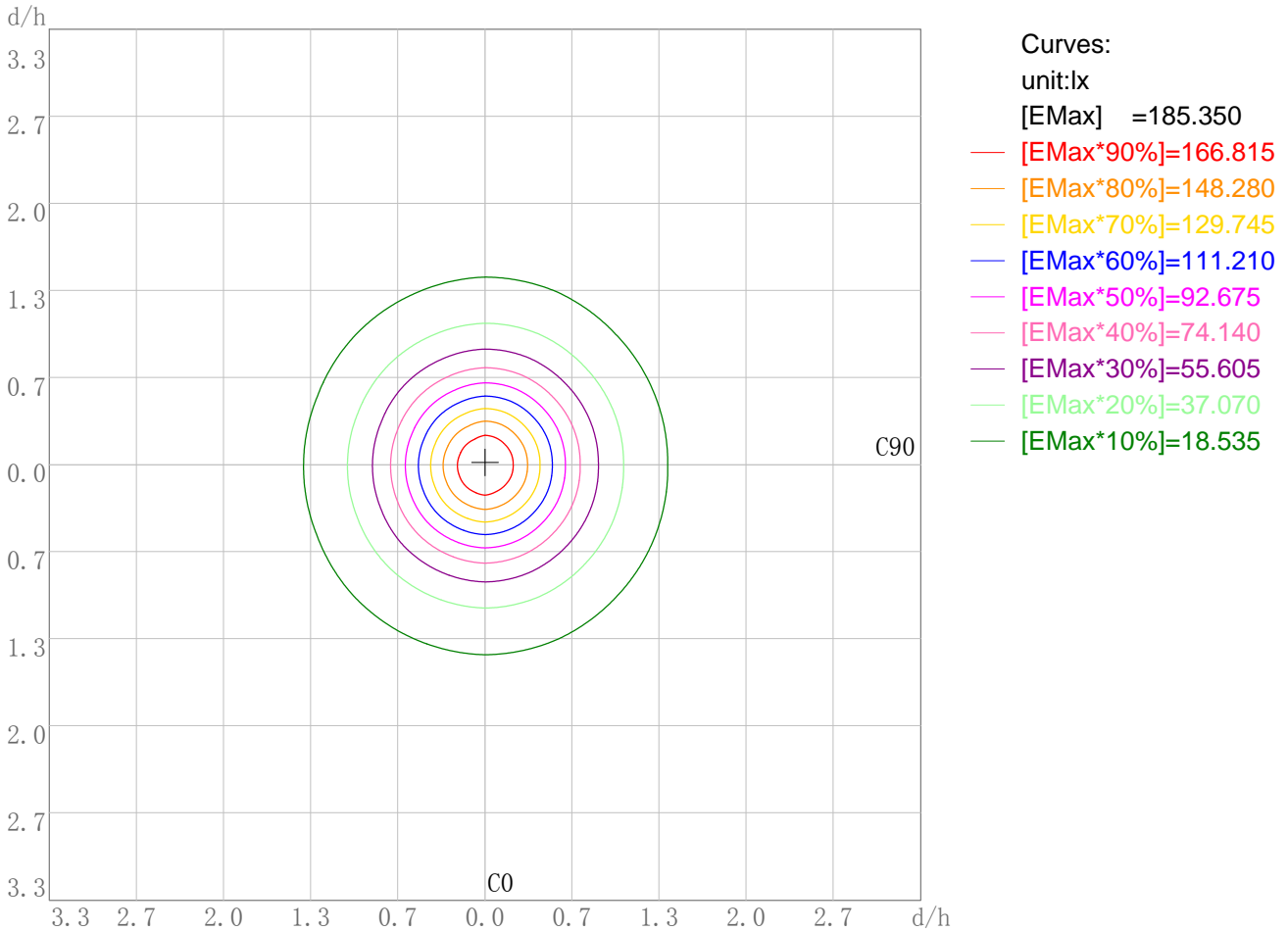

Working Plane Luminaire Mounting Height(m): 3.00

Working Plane Maximum Illuminance(lx): 185.35

Working Plane Maximum Illuminance Position(d/h):H0.0 V-0.0

IES Indoor Report

Photometric Filename: TPATPD24DLA-40WB-35K.IES

3D Plane ISO Illuminance Diagram

Lum. Name: TPATPD24DLA-40WB-35K	Lum. Catalog: TPATPD24DLA-40WB-3	Test ID:
Lamp Name: 40W	Lamp Catalog: TPATPD24DLA-40WB-3	Test Lab:
Manufacture:	Test Machine: GON-2000	Test Date: 2019/07/20

3D Plane Illuminance Modal

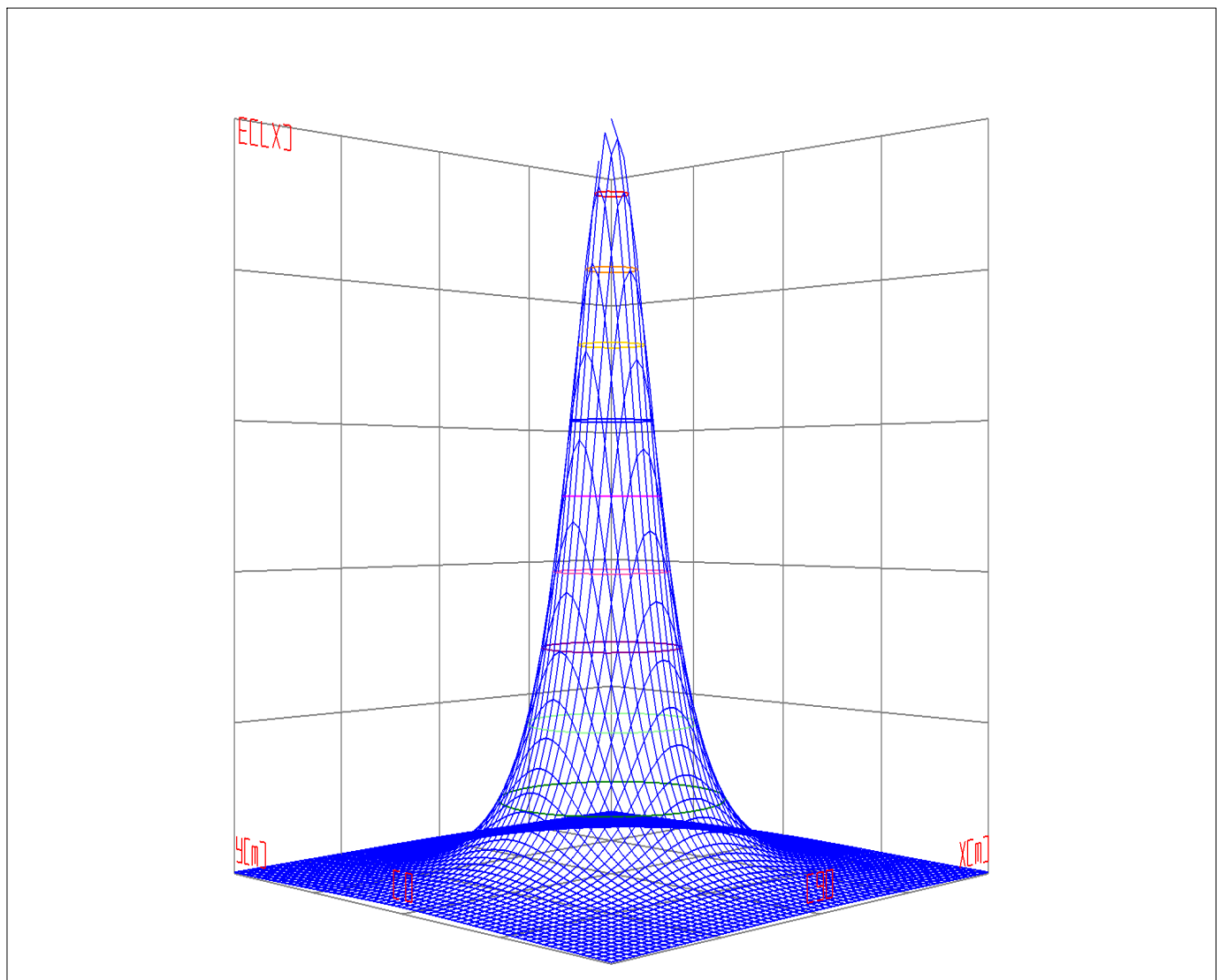

Curves: 3D Model — 90% — 80% — 70% — 60% — 50% — 40% — 30% — 20% — 10% —
View Angles(deg): 0 Height(m): 3.0 Distance(m): 10.0

IES Indoor Report

Photometric Filename: TPATPD24DLA-40WB-35K.IES

Space ISO Illuminance Diagram

Lum. Name: TPATPD24DLA-40WB-35K	Lum. Catalog:	Test ID:
Lamp Name: 40W	Lamp Catalog: TPATPD24DLA-40WB-3	Test Lab:
Manufacture:	Test Machine: GON-2000	Test Date: 2019/07/20

Space ISO Illuminance Curve

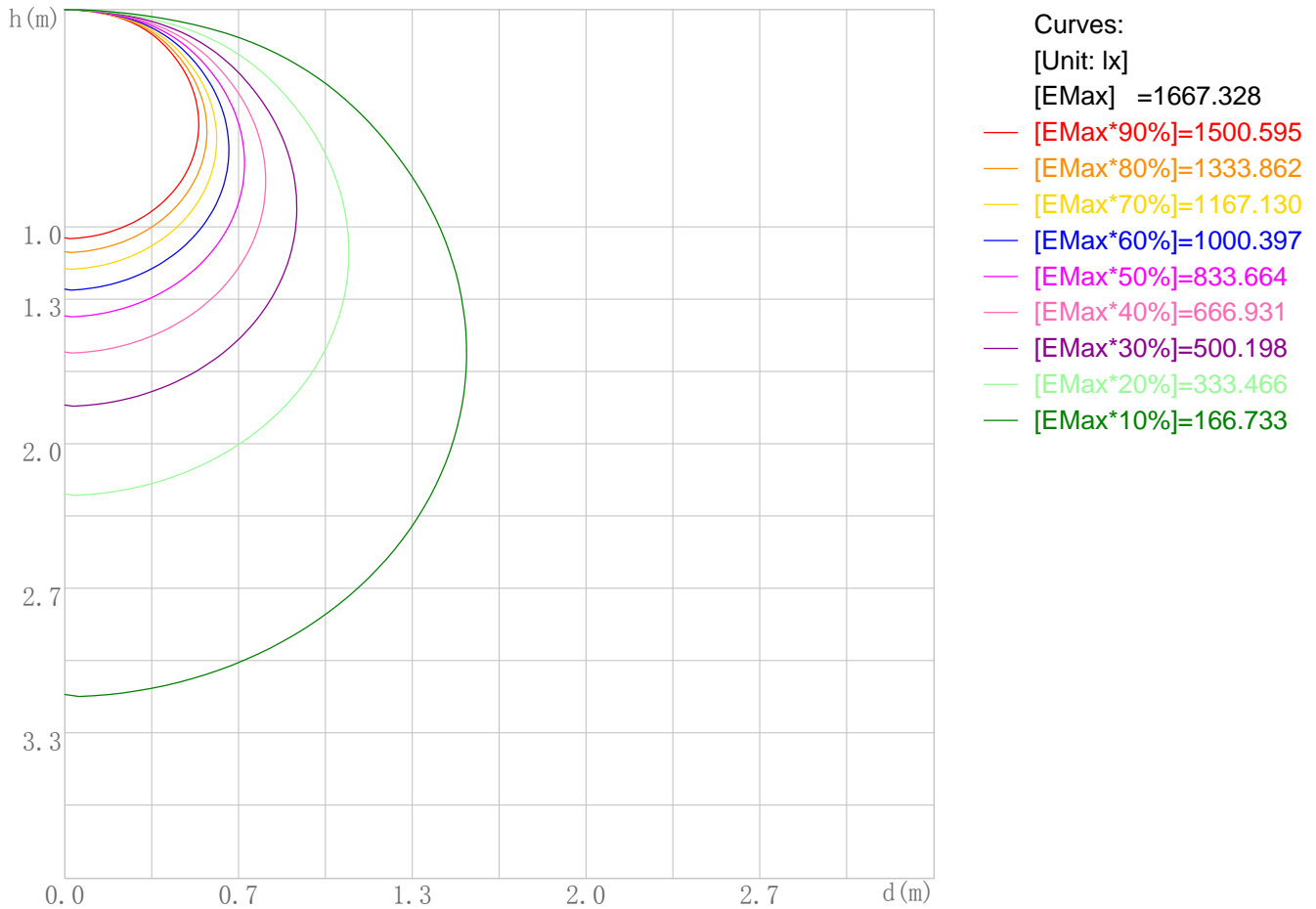

Space Plane Maximum Illuminance and @Angle:1667.33lx,1.0deg
Plane Maximum Lighting Intensity and @Angle:1668.090cd,0deg

IES Indoor Report

Photometric Filename: TPATPD24DLA-40WB-35K.IES

Illuminance-Distance Diagram

Lum. Name: TPATPD24DLA-40WB-35K	Lum. Catalog:	Test ID:
Lamp Name: 40W	Lamp Catalog: TPATPD24DLA-40WB-3	Test Lab:
Manufacture:	Test Machine: GON-2000	Test Date: 2019/07/20

Illuminance-Distance Curve

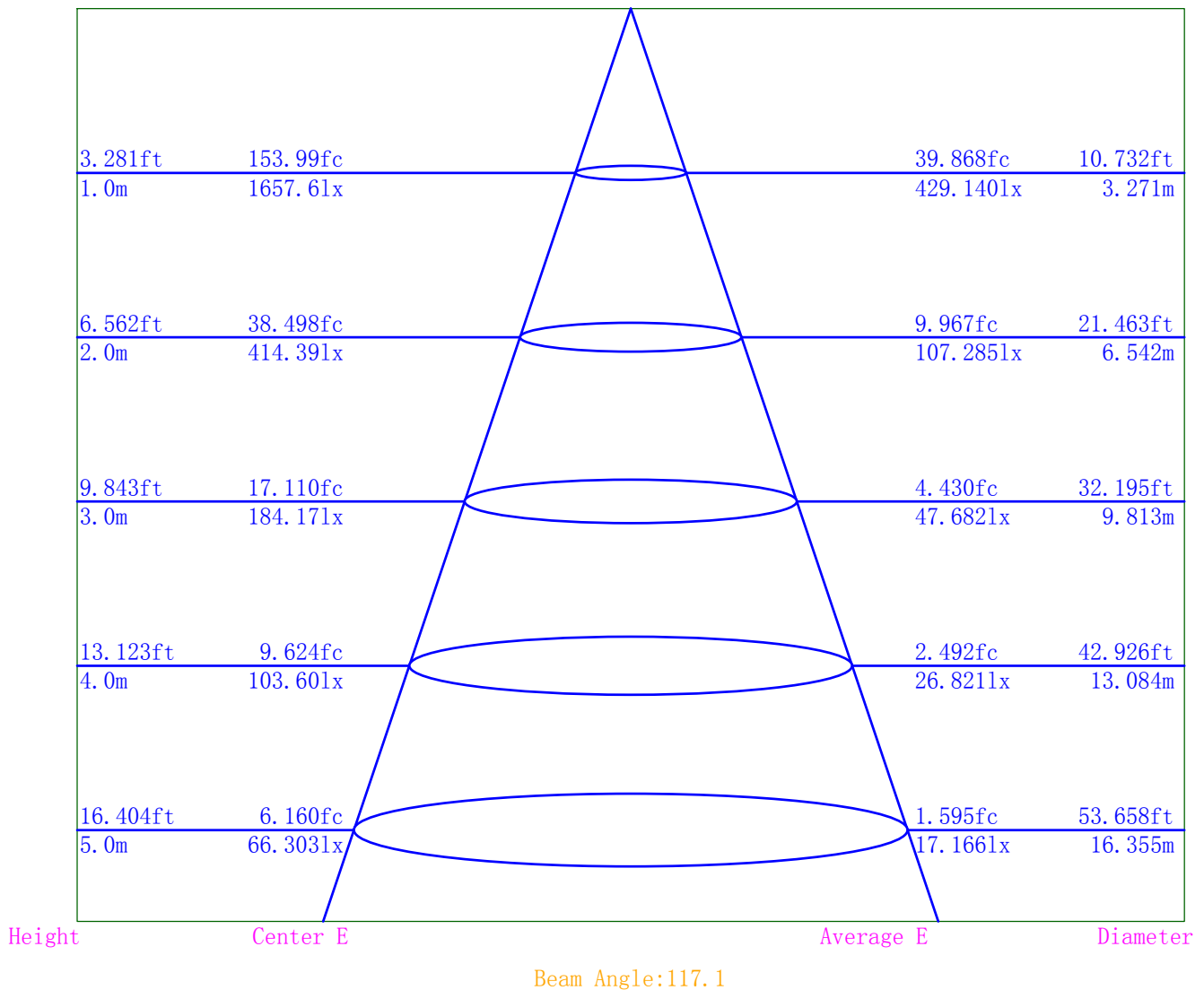

Indoor Luminance Limiting Curves

Lum. Name: TPATPD24DLA-40WB-35K	Lum. Catalog:	Test ID:
Lamp Name: 40W	Lamp Catalog: TPATPD24DLA-40WB-3	Test Lab:
Manufacture:	Test Machine:GON-2000	Test Date: 2019/07/20

Glare Grade Table

GI	Quality	Using Illuminance							
		a	b	c	d	e	f	g	h
1.15	A	2000	1000	500	<=300				
1.5	B		2000	1000	500	<=300			
1.85	C			2000	1000	500	<=300		
2.2	D				2000	1000	500	<=300	
2.55	E	a				2000	1000	500	<=300
			b	c	d	e	f	g	h

Luminance Table

Gama (deg)	45	50	55	60	65	70	75	80	85
C0	2231	2214	2208	2222	2292	2468	2752	3076	2846
C90	2133	2091	2044	1994	1938	1876	1819	1785	1864

Luminance Limiting Curve

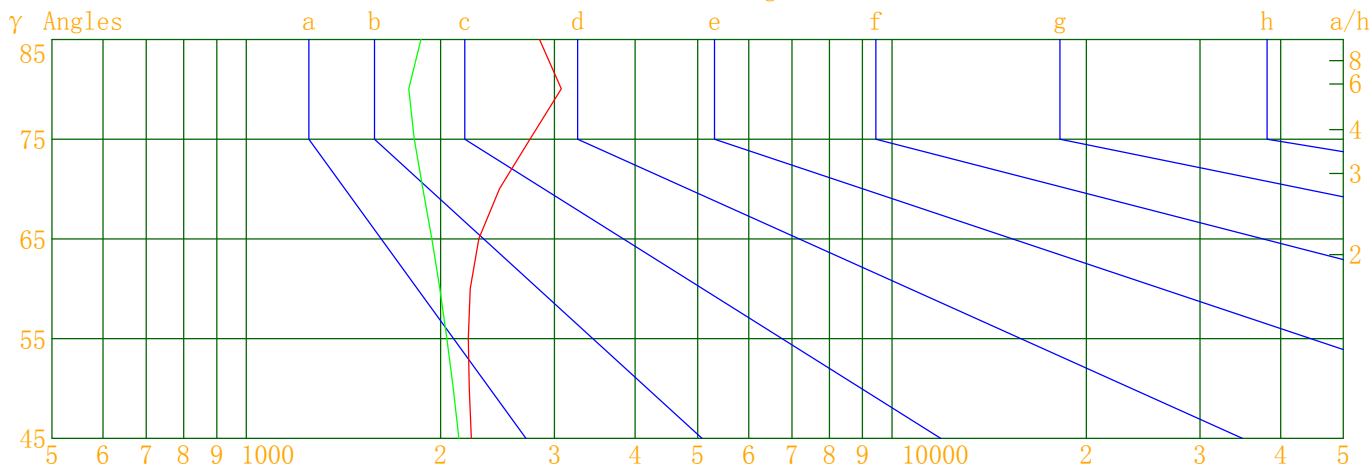

Luminous Size: Length(m)=1.120 Width(m)=0.603 Height(m)=0.030 Area(m²)=0.708960
 Luminous Type: Without Luminous Side
 Luminous Curves: C0-C180 Color: — C90-C270 Color: —

IES Indoor Report

Photometric Filename: TPATPD24DLA-40WB-35K.IES

Indoor Budgetary Estimate Table

Lum. Name: TPATPD24DLA-40WB-35K	Lum. Catalog:	Test ID:
Lamp Name: 40W	Lamp Catalog: TPATPD24DLA-40WB-3	Test Lab:
Manufacture:	Test Machine: GON-2000	Test Date: 2019/07/20

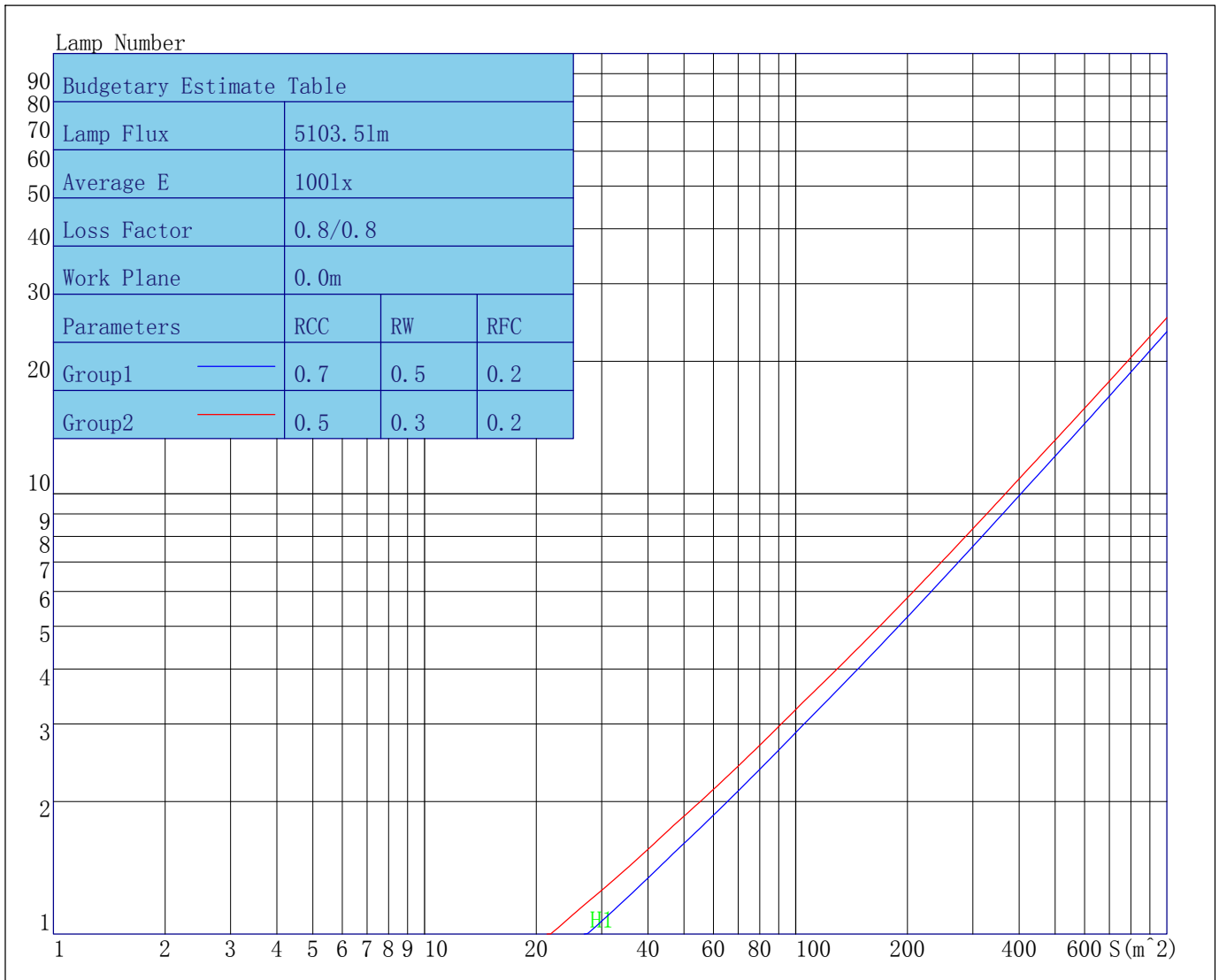

Parameters1: Rhocc = 0.7 Rhow = 0.5 Rhofc = 0.2 LLF = 0.8
 Parameters2: Rhocc = 0.5 Rhow = 0.3 Rhofc = 0.2 LLF = 0.8
 Average Illuminance(lx): 100 Cavity Height: H1(m) = 2

IES Indoor Report

Photometric Filename: TPATPD24DLA-40WB-35K.IES

Indoor Coefficient of Utilization Table

Lum. Name: TPATPD24DLA-40WB-35K	Lum. Catalog:	Test ID:
Lamp Name: 40W	Lamp Catalog: TPATPD24DLA-40WB-3	Test Lab:
Manufacture:	Test Machine: GON-2000	Test Date: 2019/07/20

Coefficients of Utilization - Zonal Cavity Method																		
Coef.	Effective Floor Cavity Reflectance RFC=0.20																	
RhoCC (%)	80				70				50			30			10			0
RhoW (%)	70	50	30	10	70	50	30	10	50	30	10	50	30	10	50	30	10	0
RCR	Coefficient of Utilization (%)																	
0	118	118	118	118	115	115	115	115	110	110	110	104	104	104	99	99	99	97
1	107	102	97	93	104	99	95	91	94	91	88	90	87	85	86	84	82	79
2	97	88	81	75	94	86	79	74	82	76	72	78	74	69	75	71	67	65
3	88	77	69	62	85	75	67	61	72	65	60	69	63	58	66	61	57	54
4	81	68	59	52	78	67	58	52	64	56	50	61	55	49	58	53	49	46
5	74	61	51	45	72	59	51	44	57	49	44	55	48	43	53	47	42	40
6	68	55	45	39	66	54	45	39	51	44	38	49	43	37	48	42	37	35
7	63	49	41	34	61	49	40	34	47	39	34	45	38	33	43	37	33	31
8	59	45	36	31	57	44	36	30	43	35	30	41	35	30	40	34	29	27
9	55	41	33	27	53	41	33	27	39	32	27	38	31	27	37	31	26	25
10	52	38	30	25	50	38	30	25	36	29	24	35	29	24	34	28	24	22

IES Indoor Report

Photometric Filename:TPATPD24DLA-40WB-35K.IES

Unified Glare Rating Table

Lum. Name: TPATPD24DLA-40WB-35K	Lum. Catalog:	Test ID:
Lamp Name: 40W	Lamp Catalog: TPATPD24DLA-40WB-3	Test Lab:
Manufacture:	Test Machine:GON-2000	Test Date: 2019/07/20

Unified Glare Rating Table

Ceiling RCC	0.70	0.70	0.50	0.50	0.30	0.70	0.70	0.50	0.50	0.30
Wall RW	0.50	0.30	0.50	0.30	0.30	0.50	0.30	0.50	0.30	0.30
Floor RFC	0.20	0.20	0.20	0.20	0.20	0.20	0.20	0.20	0.20	0.20
Room Size	Viewed crosswise					Viewed endwise				
X=2H Y=2H	14.9	16.5	15.3	16.9	17.3	14.6	16.2	15.0	16.5	16.9
Y=3H	17.0	18.5	17.4	18.9	19.3	16.2	17.7	16.7	18.1	18.5
Y=4H	18.1	19.5	18.6	19.9	20.4	17.0	18.4	17.4	18.8	19.2
Y=6H	19.2	20.5	19.7	20.9	21.4	17.6	18.9	18.1	19.3	19.8
Y=8H	19.6	20.9	20.1	21.3	21.8	17.8	19.1	18.3	19.5	20.0
Y=12H	19.9	21.1	20.4	21.5	22.0	18.0	19.2	18.5	19.7	20.2
X=4H Y=2H	15.6	17.0	16.1	17.4	17.9	15.4	16.8	15.9	17.2	17.7
Y=3H	18.0	19.2	18.5	19.6	20.1	17.3	18.5	17.8	19.0	19.4
Y=4H	19.3	20.3	19.8	20.8	21.3	18.2	19.3	18.7	19.8	20.3
Y=6H	20.5	21.5	21.0	22.0	22.5	19.0	19.9	19.5	20.4	20.9
Y=8H	21.0	21.9	21.5	22.4	22.9	19.3	20.2	19.8	20.7	21.2
Y=12H	21.4	22.2	21.9	22.7	23.2	19.6	20.4	20.1	20.9	21.4
X=8H Y=4H	19.7	20.6	20.2	21.0	21.6	18.8	19.7	19.3	20.2	20.7
Y=6H	21.1	21.9	21.7	22.4	23.1	19.8	20.5	20.3	21.1	21.7
Y=8H	21.8	22.4	22.3	23.0	23.5	20.2	20.9	20.8	21.5	22.0
Y=12H	22.2	22.8	22.8	23.4	24.0	20.7	21.3	21.2	21.8	22.4
X=12H Y=4H	19.7	20.5	20.2	21.0	21.6	19.0	19.8	19.5	20.3	20.8
Y=6H	21.2	21.9	21.8	22.4	23.0	20.0	20.7	20.6	21.2	21.8
Y=8H	21.9	22.5	22.5	23.1	23.7	20.6	21.2	21.1	21.7	22.3
Variations with the observer position at spacings										
S=1.0H	0.3/-0.3					0.4/-0.4				
S=1.5H	0.4/-0.5					0.6/-0.7				
S=2.0H	0.4/-0.5					0.7/-0.8				
Reduced UGR Table:										
Nordic Standard Table:	BKO					BKO				
Correction Value	4.1					3.6				

to the CIE Pub.117, data has been corrected, refers to the lamp's lumens 8.2flm.

IES Indoor Report

Photometric Filename:TPATPD24DLA-40WB-35K.IES

Candela Tabulation

V/H	C0.0	C22.5	C45.0	C67.5	C90.0	C112.5	C135.0	C157.5	C180.0	C202.5	C225.0	C247.5
γ 0.0	1657.57	1657.57	1657.57	1657.57	1657.57	1657.57	1657.57	1657.57	1657.57	1657.57	1657.57	1657.57
γ 1.0	1668.09	1659.97	1656.53	1654.84	1653.31	1652.11	1651.47	1651.84	1668.91	1660.20	1656.79	1654.44
γ 2.0	1666.81	1659.17	1655.49	1654.15	1652.58	1651.72	1651.05	1651.61	1668.44	1659.39	1656.04	1653.13
γ 3.0	1664.95	1657.51	1653.95	1652.80	1651.06	1650.59	1649.99	1650.62	1667.45	1657.95	1654.84	1651.39
γ 4.0	1662.56	1655.46	1651.67	1650.75	1649.05	1648.77	1648.23	1649.24	1665.67	1655.84	1652.74	1648.71
γ 5.0	1659.45	1652.90	1648.65	1648.07	1646.11	1646.55	1645.99	1647.22	1663.48	1653.58	1650.07	1645.62
γ 6.0	1655.95	1649.57	1645.39	1644.66	1642.91	1643.46	1643.07	1644.60	1660.75	1650.49	1646.79	1641.77
γ 7.0	1652.06	1645.66	1641.03	1640.69	1638.61	1639.94	1639.51	1641.23	1657.23	1646.65	1642.85	1637.10
γ 8.0	1647.30	1641.24	1636.19	1636.02	1633.87	1635.56	1635.07	1637.69	1653.32	1642.33	1638.29	1632.13
γ 9.0	1642.21	1636.13	1631.05	1630.92	1628.53	1630.60	1630.48	1633.33	1649.08	1637.43	1633.19	1626.25
γ 10.0	1636.08	1630.70	1624.95	1625.04	1622.43	1625.09	1625.06	1628.45	1644.02	1632.05	1627.49	1619.95
γ 11.0	1629.64	1624.49	1618.32	1618.36	1615.47	1618.68	1618.96	1622.94	1638.22	1626.09	1621.37	1613.01
γ 12.0	1622.79	1617.66	1611.25	1611.15	1608.30	1611.75	1612.56	1616.78	1632.28	1619.27	1614.43	1605.28
γ 13.0	1615.11	1610.38	1603.33	1603.35	1600.19	1604.46	1605.22	1610.28	1625.33	1612.34	1606.74	1597.04
γ 14.0	1607.03	1602.54	1595.03	1595.00	1591.49	1596.39	1597.27	1602.98	1618.04	1604.46	1598.80	1587.94
γ 15.0	1598.60	1593.90	1586.29	1585.98	1582.40	1587.61	1589.16	1595.47	1610.18	1596.05	1590.07	1578.63
γ 16.0	1589.32	1585.19	1576.85	1576.66	1572.86	1578.61	1580.23	1587.06	1601.67	1587.37	1580.87	1568.83
γ 17.0	1579.62	1575.60	1566.51	1566.25	1562.07	1568.49	1570.80	1578.34	1592.81	1578.19	1571.43	1558.08
γ 18.0	1569.63	1565.30	1556.08	1555.19	1551.29	1557.85	1560.58	1568.86	1583.29	1568.18	1560.86	1546.75
γ 19.0	1558.66	1554.85	1544.85	1544.06	1539.59	1546.96	1550.07	1559.02	1573.25	1557.90	1549.82	1535.25
γ 20.0	1547.67	1543.60	1533.37	1532.19	1527.76	1535.25	1538.60	1548.42	1562.76	1546.65	1538.44	1522.60
γ 21.0	1535.72	1531.84	1521.12	1519.61	1514.95	1523.01	1527.17	1537.35	1551.42	1534.85	1526.33	1509.55
γ 22.0	1523.22	1519.82	1508.16	1506.87	1501.55	1510.52	1514.73	1526.10	1539.75	1523.13	1513.64	1496.62
γ 23.0	1510.52	1506.89	1495.16	1493.10	1487.99	1497.04	1502.29	1513.76	1528.02	1510.35	1501.13	1482.53
γ 24.0	1497.34	1493.40	1480.96	1478.84	1473.39	1483.36	1488.76	1501.17	1514.91	1497.83	1487.27	1467.97
γ 25.0	1483.24	1479.97	1466.49	1464.48	1458.30	1468.76	1474.58	1488.36	1501.72	1484.00	1473.02	1453.23
γ 26.0	1469.28	1465.60	1452.11	1449.30	1443.42	1454.03	1460.73	1474.51	1488.30	1469.60	1458.56	1437.41
γ 27.0	1454.41	1451.32	1436.63	1434.09	1427.34	1439.10	1445.69	1460.78	1473.96	1455.29	1443.33	1421.68
γ 28.0	1438.93	1435.91	1420.62	1417.79	1410.82	1422.88	1430.17	1446.19	1459.60	1440.18	1428.18	1405.29
γ 29.0	1423.52	1419.96	1404.53	1400.78	1394.26	1406.32	1414.57	1430.83	1444.31	1424.47	1411.96	1388.29
γ 30.0	1407.13	1404.00	1387.60	1384.03	1376.58	1389.82	1398.04	1415.33	1428.49	1408.86	1395.14	1371.37
γ 31.0	1390.22	1387.33	1370.11	1366.36	1358.63	1372.27	1381.09	1399.39	1412.62	1392.15	1378.58	1353.33
γ 32.0	1373.66	1370.30	1353.06	1348.44	1340.88	1354.61	1364.34	1382.78	1395.85	1374.96	1360.86	1334.76
γ 33.0	1356.02	1353.30	1334.88	1330.49	1321.99	1336.93	1346.80	1366.33	1378.63	1357.97	1342.92	1316.34
γ 34.0	1338.02	1335.16	1316.26	1311.38	1303.33	1318.01	1328.52	1348.93	1361.76	1340.28	1325.19	1297.22
γ 35.0	1319.96	1316.59	1297.61	1291.76	1283.65	1298.47	1310.43	1330.82	1343.91	1321.91	1306.43	1277.70
γ 36.0	1301.17	1298.25	1278.14	1272.44	1263.26	1279.45	1291.16	1313.09	1325.46	1303.81	1287.22	1258.12
γ 37.0	1282.48	1279.01	1258.85	1252.22	1243.43	1259.43	1272.44	1294.28	1307.25	1284.63	1267.93	1237.59
γ 38.0	1262.93	1259.49	1238.79	1231.52	1222.70	1239.13	1252.73	1275.44	1287.90	1264.99	1247.85	1216.61
γ 39.0	1243.01	1240.29	1218.16	1211.54	1201.74	1219.18	1232.53	1256.76	1268.41	1245.56	1227.48	1196.09
γ 40.0	1223.37	1220.09	1198.03	1190.21	1180.98	1198.16	1212.66	1236.93	1249.11	1225.64	1207.64	1174.84
γ 41.0	1202.83	1199.33	1176.71	1168.51	1159.07	1177.07	1191.78	1217.17	1228.96	1205.94	1186.67	1152.97
γ 42.0	1181.88	1178.96	1155.18	1147.14	1136.71	1155.21	1170.45	1196.76	1209.04	1185.23	1165.87	1131.56
γ 43.0	1161.47	1157.83	1133.61	1124.97	1115.03	1133.17	1149.71	1176.04	1188.24	1163.97	1144.01	1109.07
γ 44.0	1140.07	1137.27	1111.71	1103.18	1092.47	1111.66	1127.82	1155.82	1166.98	1143.08	1122.11	1086.90
γ 45.0	1118.49	1115.54	1089.18	1080.71	1069.51	1089.27	1105.87	1134.77	1146.41	1121.37	1100.52	1064.05
γ 46.0	1097.25	1093.63	1067.30	1057.77	1047.17	1066.31	1084.18	1113.10	1124.79	1099.75	1078.17	1041.05

IES Indoor Report

Photometric Filename:TPATPD24DLA-40WB-35K.IES

Candela Tabulation - (Cont.)

V/H	C0.0	C22.5	C45.0	C67.5	C90.0	C112.5	C135.0	C157.5	C180.0	C202.5	C225.0	C247.5
γ 47.0	1075.23	1071.99	1044.47	1035.06	1023.75	1043.95	1061.65	1091.87	1103.12	1078.36	1055.66	1018.54
γ 48.0	1053.04	1049.55	1021.23	1011.36	999.94	1020.32	1038.77	1069.82	1081.79	1056.39	1033.40	995.00
γ 49.0	1031.29	1027.17	998.60	987.89	976.93	996.75	1016.38	1047.83	1059.66	1034.00	1010.00	971.39
γ 50.0	1009.09	1005.31	975.62	964.91	952.98	974.04	993.23	1026.31	1037.49	1012.01	986.93	948.01
γ 51.0	987.41	983.03	952.84	941.15	929.43	950.23	970.94	1004.02	1015.82	989.39	964.45	923.68
γ 52.0	964.88	960.01	929.18	916.59	905.09	926.06	947.59	981.56	993.52	967.14	940.87	899.56
γ 53.0	942.18	937.72	905.43	892.98	880.37	902.54	923.97	959.70	971.40	945.32	917.47	875.97
γ 54.0	920.11	914.67	882.14	868.27	856.29	878.04	900.94	937.01	949.78	922.66	894.67	851.30
γ 55.0	897.70	891.80	858.23	843.74	831.19	853.46	877.29	914.33	927.22	900.06	870.91	826.30
γ 56.0	875.21	869.68	834.40	819.72	806.34	829.75	853.65	892.52	904.90	877.58	847.17	801.45
γ 57.0	853.54	846.90	811.20	795.03	782.01	805.15	830.75	869.97	883.30	854.32	824.20	776.24
γ 58.0	831.39	824.00	787.31	769.91	756.81	780.07	807.18	848.12	861.16	832.03	800.69	751.60
γ 59.0	809.21	801.80	763.53	745.52	731.49	756.08	783.30	825.38	839.99	810.77	778.02	727.63
γ 60.0	787.69	779.17	740.14	720.41	706.73	731.00	760.43	802.83	818.07	788.59	754.68	702.43
γ 61.0	766.01	757.55	716.46	696.16	681.18	706.90	736.79	781.38	796.17	766.57	731.24	678.25
γ 62.0	744.84	735.55	693.21	671.23	655.74	682.06	713.49	759.63	775.41	744.85	708.51	653.18
γ 63.0	725.14	713.72	670.61	646.29	631.01	657.18	690.86	737.61	755.03	723.25	685.48	628.47
γ 64.0	705.61	692.93	647.29	621.85	605.49	632.82	667.81	716.60	735.40	703.34	662.59	604.87
γ 65.0	686.81	672.01	624.78	596.74	580.69	607.77	644.70	695.36	717.08	683.48	640.68	580.31
γ 66.0	668.85	652.05	602.03	571.69	554.97	582.80	622.55	675.26	698.57	664.23	618.16	555.67
γ 67.0	650.91	633.34	579.46	547.73	529.55	558.78	600.06	656.48	680.14	646.01	595.64	531.88
γ 68.0	633.48	615.02	557.75	523.05	505.18	534.39	578.34	637.83	662.72	627.45	573.93	507.78
γ 69.0	615.96	596.82	535.62	498.93	479.88	510.23	555.94	619.29	644.89	609.27	552.29	483.81
γ 70.0	598.35	579.17	514.20	475.31	454.96	486.74	534.10	601.67	627.08	591.79	531.52	461.25
γ 71.0	581.01	560.98	494.23	451.26	430.66	462.60	513.56	583.52	609.75	573.54	512.25	437.84
γ 72.0	562.74	542.72	474.25	427.31	405.88	438.77	493.22	564.98	591.36	554.93	492.64	414.56
γ 73.0	543.88	525.20	455.26	404.64	381.42	416.07	473.64	547.41	572.76	536.26	473.83	392.06
γ 74.0	525.09	506.47	436.96	381.65	357.97	393.17	455.23	529.02	552.90	516.52	454.79	369.43
γ 75.0	505.02	487.50	418.37	358.98	333.85	370.49	436.03	510.48	531.94	496.38	435.77	346.98
γ 76.0	483.69	467.93	399.86	336.97	310.26	348.49	417.18	490.38	510.69	474.78	417.36	325.59
γ 77.0	461.95	446.78	382.10	314.64	287.45	325.85	399.05	469.13	487.24	451.75	397.94	303.96
γ 78.0	436.78	425.04	363.02	293.34	264.19	304.57	380.42	447.17	461.06	426.97	377.92	283.68
γ 79.0	408.66	400.40	342.88	271.98	242.18	282.74	360.64	422.59	432.47	398.05	356.80	263.90
γ 80.0	378.65	373.36	322.34	252.32	219.75	261.97	340.44	395.19	399.42	365.96	333.64	245.03
γ 81.0	342.01	343.86	299.27	234.47	197.61	243.32	318.06	365.90	361.55	330.27	307.73	227.49
γ 82.0	303.25	308.33	273.70	216.69	176.69	224.74	293.24	330.62	321.46	290.50	279.40	209.43
γ 83.0	261.20	269.05	244.28	199.68	155.47	206.76	264.35	291.36	278.51	248.61	246.31	190.16
γ 84.0	217.95	229.22	210.50	182.44	134.91	189.64	231.43	251.15	234.28	206.83	209.33	169.09
γ 85.0	175.85	187.54	175.21	162.81	115.15	171.62	196.35	209.17	190.41	162.95	172.07	143.37
γ 86.0	134.47	146.13	137.76	140.19	95.59	151.32	158.99	166.88	146.80	121.75	132.35	114.92
γ 87.0	95.25	108.43	99.96	115.43	76.68	128.16	120.63	127.64	105.98	84.52	95.59	85.50
γ 88.0	58.79	71.22	66.91	86.67	59.64	100.59	86.25	89.28	68.07	48.62	61.68	55.09
γ 89.0	37.56	41.93	38.50	56.39	43.30	70.81	53.03	52.57	40.96	36.97	37.03	34.26
γ 90.0	33.90	34.13	32.54	32.90	32.96	42.74	33.87	35.68	36.60	35.35	34.47	32.70
γ 91.0	32.85	32.78	31.51	30.58	30.55	31.79	32.44	33.47	35.35	34.34	33.38	31.81
γ 92.0	32.02	31.95	30.68	29.80	29.66	30.67	31.46	32.60	34.41	33.57	32.44	30.82
γ 93.0	31.22	31.16	29.95	29.15	28.89	29.97	30.58	31.78	33.58	32.74	31.75	30.08

IES Indoor Report

Photometric Filename:TPATPD24DLA-40WB-35K.IES

Candela Tabulation - (Cont.)

V/H	C0.0	C22.5	C45.0	C67.5	C90.0	C112.5	C135.0	C157.5	C180.0	C202.5	C225.0	C247.5
γ 94.0	30.60	30.56	29.42	28.44	28.32	29.18	30.06	31.12	32.86	32.06	30.95	29.36
γ 95.0	30.00	30.01	28.66	27.86	27.71	28.55	29.35	30.53	32.18	31.44	30.21	28.55
γ 96.0	29.44	29.48	28.17	27.33	27.13	27.95	28.68	29.91	31.55	30.79	29.65	28.06
γ 97.0	29.07	28.89	27.68	26.89	26.65	27.41	28.16	29.33	30.98	30.25	29.06	27.46
γ 98.0	28.65	28.43	27.19	26.44	26.12	26.99	27.66	28.95	30.34	29.75	28.58	27.07
γ 99.0	28.21	28.04	26.76	25.96	25.72	26.36	27.25	28.43	29.98	29.13	28.17	26.56
γ 100.0	27.77	27.68	26.38	25.58	25.34	26.00	26.78	28.01	29.50	28.64	27.60	25.96
γ 101.0	27.39	27.17	25.94	25.09	24.93	25.59	26.33	27.60	29.03	28.30	27.05	25.52
γ 102.0	27.06	26.83	25.72	24.77	24.50	25.18	26.00	27.34	28.59	27.81	26.77	25.07
γ 103.0	26.67	26.38	25.25	24.45	24.13	24.81	25.73	26.84	28.15	27.31	26.35	24.69
γ 104.0	26.31	26.06	24.98	24.03	23.77	24.37	25.24	26.56	27.63	26.84	25.95	24.32
γ 105.0	25.93	25.80	24.68	23.68	23.43	24.08	25.02	26.17	27.15	26.36	25.58	24.02
γ 106.0	25.65	25.54	24.28	23.33	23.02	23.81	24.64	25.80	26.75	25.79	25.14	23.69
γ 107.0	25.33	25.07	23.99	23.18	22.71	23.39	24.37	25.43	26.17	25.41	24.75	23.29
γ 108.0	24.92	24.70	23.61	22.76	22.32	22.90	24.07	25.14	25.73	24.88	24.26	22.92
γ 109.0	24.60	24.37	23.40	22.62	22.03	22.71	23.70	24.78	25.14	24.53	23.71	22.57
γ 110.0	24.21	24.01	23.09	22.19	21.71	22.31	23.35	24.28	24.70	23.96	23.22	22.11
γ 111.0	23.82	23.55	22.66	21.90	21.43	21.98	23.05	24.06	24.09	23.49	22.90	21.74
γ 112.0	23.43	23.27	22.34	21.59	21.27	21.62	22.73	23.71	23.66	23.11	22.41	21.34
γ 113.0	23.16	22.97	22.07	21.35	20.87	21.40	22.27	23.23	23.19	22.61	22.05	20.97
γ 114.0	22.67	22.54	21.69	20.89	20.59	21.09	22.03	22.95	22.73	22.20	21.67	20.63
γ 115.0	22.26	22.14	21.46	20.78	20.35	20.77	21.67	22.55	22.32	21.82	21.29	20.22
γ 116.0	21.90	21.81	21.10	20.41	20.11	20.58	21.47	22.26	22.00	21.44	20.97	20.09
γ 117.0	21.70	21.46	20.74	20.23	19.81	20.38	21.17	21.89	21.54	21.23	20.70	19.88
γ 118.0	21.42	21.24	20.54	19.87	19.64	20.04	20.84	21.72	21.29	20.85	20.55	19.65
γ 119.0	21.12	20.93	20.25	19.79	19.48	19.75	20.71	21.35	21.05	20.76	20.39	19.46
γ 120.0	20.73	20.68	20.09	19.51	19.19	19.62	20.33	21.14	20.82	20.48	19.99	19.25
γ 121.0	20.56	20.46	19.87	19.41	19.16	19.41	20.22	20.79	20.67	20.31	19.98	19.13
γ 122.0	20.32	20.19	19.65	19.14	19.05	19.21	20.08	20.51	20.43	20.14	19.71	19.07
γ 123.0	20.20	20.09	19.56	18.94	18.91	19.15	19.83	20.36	20.26	19.97	19.71	19.01
γ 124.0	20.05	19.89	19.40	18.92	18.84	19.07	19.70	20.29	20.11	19.76	19.48	18.84
γ 125.0	20.03	19.83	19.13	18.73	18.63	18.80	19.52	20.06	20.11	19.77	19.18	18.79
γ 126.0	19.84	19.67	19.19	18.83	18.55	18.76	19.45	19.86	19.99	19.65	19.40	18.69
γ 127.0	19.63	19.57	19.01	18.75	18.44	18.62	19.23	19.83	19.90	19.67	19.22	18.56
γ 128.0	19.62	19.42	19.02	18.53	18.49	18.58	19.26	19.71	19.83	19.50	19.15	18.57
γ 129.0	19.50	19.43	18.83	18.59	18.56	18.57	19.13	19.65	19.74	19.53	19.16	18.61
γ 130.0	19.40	19.37	18.83	18.59	18.44	18.54	19.19	19.60	19.70	19.48	19.03	18.59
γ 131.0	19.56	19.35	18.84	18.59	18.53	18.51	18.97	19.36	19.54	19.33	19.14	18.68
γ 132.0	19.27	19.23	18.76	18.53	18.51	18.48	19.05	19.39	19.63	19.37	19.01	18.59
γ 133.0	19.26	19.23	18.79	18.56	18.46	18.49	18.98	19.33	19.58	19.34	19.04	18.55
γ 134.0	19.23	19.29	18.79	18.58	18.56	18.50	18.98	19.32	19.42	19.23	18.98	18.77
γ 135.0	19.16	19.13	18.70	18.49	18.52	18.50	19.01	19.29	19.60	19.20	18.97	18.61
γ 136.0	19.34	19.19	18.76	18.54	18.59	18.60	18.96	19.34	19.49	19.27	19.10	18.63
γ 137.0	19.34	19.19	18.86	18.67	18.66	18.70	18.98	19.31	19.50	19.31	19.03	18.72
γ 138.0	19.36	19.30	18.83	18.68	18.63	18.66	18.98	19.32	19.50	19.27	18.99	18.80
γ 139.0	19.36	19.15	18.91	18.74	18.69	18.67	19.02	19.25	19.60	19.36	19.22	18.88
γ 140.0	19.31	19.33	18.94	18.71	18.76	18.84	19.07	19.33	19.53	19.34	19.15	18.89

IES Indoor Report

Photometric Filename:TPATPD24DLA-40WB-35K.IES

Candela Tabulation - (Cont.)

V/H	C0.0	C22.5	C45.0	C67.5	C90.0	C112.5	C135.0	C157.5	C180.0	C202.5	C225.0	C247.5
γ 141.0	19.35	19.26	18.98	18.89	18.83	18.92	19.08	19.27	19.67	19.43	19.11	18.91
γ 142.0	19.47	19.36	19.09	19.05	18.92	18.85	19.15	19.29	19.54	19.34	19.19	18.98
γ 143.0	19.52	19.42	19.16	19.12	18.99	18.99	19.27	19.37	19.71	19.43	19.15	19.03
γ 144.0	19.49	19.39	19.24	19.14	19.06	18.96	19.26	19.39	19.66	19.42	19.17	19.14
γ 145.0	19.51	19.38	19.33	19.06	19.26	19.10	19.33	19.49	19.92	19.44	19.26	19.18
γ 146.0	19.60	19.50	19.38	19.32	19.33	19.14	19.41	19.51	19.91	19.50	19.36	19.34
γ 147.0	19.68	19.60	19.32	19.35	19.38	19.21	19.51	19.61	19.95	19.60	19.44	19.41
γ 148.0	19.77	19.63	19.36	19.42	19.66	19.36	19.44	19.60	20.05	19.74	19.45	19.60
γ 149.0	19.69	19.72	19.48	19.43	19.67	19.46	19.61	19.62	20.05	19.75	19.70	19.63
γ 150.0	19.89	19.72	19.52	19.55	19.67	19.59	19.53	19.74	20.14	19.83	19.72	19.73
γ 151.0	19.91	19.75	19.62	19.72	19.72	19.80	19.78	19.77	20.08	19.85	19.78	19.73
γ 152.0	19.90	19.85	19.77	19.72	19.75	19.85	19.78	19.80	20.14	20.01	19.91	19.86
γ 153.0	20.05	19.98	19.94	19.68	19.92	19.78	19.87	19.88	20.22	19.98	19.93	19.88
γ 154.0	20.11	20.06	19.97	19.82	19.88	19.81	19.92	19.88	20.22	20.04	19.96	20.02
γ 155.0	20.06	20.12	19.93	19.91	20.06	19.93	19.85	20.02	20.35	20.08	19.98	20.01
γ 156.0	20.13	20.09	19.97	19.95	20.17	20.07	20.06	19.98	20.39	20.04	20.03	20.26
γ 157.0	20.12	20.13	20.03	20.06	20.25	20.00	20.14	20.13	20.50	20.14	20.16	20.31
γ 158.0	20.14	20.25	20.19	20.15	20.36	20.17	20.18	20.12	20.49	20.31	20.25	20.34
γ 159.0	20.31	20.31	20.20	20.12	20.34	20.25	20.26	20.23	20.58	20.34	20.34	20.49
γ 160.0	20.38	20.31	20.20	20.20	20.48	20.43	20.43	20.29	20.69	20.45	20.40	20.49
γ 161.0	20.49	20.48	20.29	20.28	20.55	20.49	20.34	20.31	20.85	20.59	20.48	20.54
γ 162.0	20.50	20.57	20.28	20.38	20.63	20.50	20.52	20.46	20.85	20.58	20.51	20.50
γ 163.0	20.52	20.47	20.41	20.54	20.73	20.65	20.58	20.43	20.88	20.67	20.62	20.69
γ 164.0	20.60	20.62	20.47	20.44	20.76	20.66	20.62	20.55	20.87	20.72	20.63	20.69
γ 165.0	20.78	20.74	20.42	20.55	20.87	20.64	20.60	20.64	20.96	20.80	20.69	20.70
γ 166.0	20.69	20.75	20.54	20.51	20.98	20.78	20.75	20.81	20.95	20.84	20.76	20.86
γ 167.0	20.86	20.83	20.47	20.60	20.98	20.77	20.74	20.72	20.92	20.73	20.73	20.87
γ 168.0	20.77	20.65	20.66	20.67	21.00	20.92	20.79	20.81	20.97	20.74	20.78	20.84
γ 169.0	20.78	20.82	20.69	20.69	21.11	20.94	20.87	20.85	20.93	21.00	20.89	21.00
γ 170.0	20.86	20.92	20.87	20.85	21.19	20.94	20.76	20.89	21.05	20.97	20.92	21.03
γ 171.0	20.94	20.82	20.65	20.96	21.15	20.90	20.96	21.01	21.09	20.92	21.02	21.11
γ 172.0	20.89	20.91	20.84	20.93	21.33	21.01	20.86	20.96	21.10	20.90	21.12	21.09
γ 173.0	20.91	20.95	20.74	20.92	21.31	20.95	20.98	21.11	21.03	20.99	21.07	21.10
γ 174.0	21.03	20.97	20.89	20.93	21.42	21.15	21.02	21.02	21.14	21.08	21.13	21.11
γ 175.0	20.97	20.97	20.80	21.04	21.49	21.15	21.14	21.06	21.08	21.01	21.19	21.27
γ 176.0	20.91	21.01	20.83	21.11	21.42	21.13	21.11	21.03	21.16	21.06	21.19	21.17
γ 177.0	20.88	21.05	21.05	21.15	21.61	21.28	21.14	21.20	21.17	21.05	21.21	21.38
γ 178.0	21.01	21.03	20.97	21.13	21.50	21.28	21.22	21.16	21.27	21.11	21.16	21.22
γ 179.0	21.07	21.07	20.97	21.34	21.48	21.18	21.21	21.13	21.22	21.07	21.15	21.26
γ 180.0	21.21	21.21	21.21	21.21	21.21	21.21	21.21	21.21	21.21	21.21	21.21	21.21
V/H	C270.0	C292.5	C315.0	C337.5								
γ 0.0	1657.57	1657.57	1657.57	1657.57								
γ 1.0	1652.84	1650.77	1650.60	1650.51								
γ 2.0	1651.50	1649.29	1649.11	1649.08								
γ 3.0	1649.69	1646.95	1647.07	1646.90								
γ 4.0	1647.04	1644.07	1644.47	1644.32								
γ 5.0	1643.79	1640.56	1641.19	1640.99								

IES Indoor Report

Photometric Filename:TPATPD24DLA-40WB-35K.IES

Candela Tabulation - (Cont.)

V/H	C270.0	C292.5	C315.0	C337.5
γ 6.0	1639.77	1636.29	1637.46	1637.19
γ 7.0	1635.25	1631.47	1632.96	1632.78
γ 8.0	1629.80	1626.14	1627.62	1627.85
γ 9.0	1624.05	1619.83	1622.00	1622.23
γ 10.0	1617.35	1613.11	1615.75	1616.10
γ 11.0	1610.30	1605.89	1609.02	1609.41
γ 12.0	1602.63	1597.95	1601.34	1602.15
γ 13.0	1594.11	1589.41	1593.23	1594.28
γ 14.0	1585.36	1580.25	1584.70	1585.94
γ 15.0	1575.69	1570.35	1575.69	1576.94
γ 16.0	1565.33	1560.33	1565.87	1567.65
γ 17.0	1554.86	1549.18	1555.65	1557.64
γ 18.0	1543.25	1537.57	1544.69	1546.89
γ 19.0	1531.16	1525.83	1532.90	1536.06
γ 20.0	1518.65	1512.83	1521.25	1524.16
γ 21.0	1505.54	1499.61	1508.58	1511.81
γ 22.0	1491.86	1486.24	1495.46	1499.47
γ 23.0	1478.05	1471.97	1482.20	1486.29
γ 24.0	1463.18	1457.15	1467.97	1472.47
γ 25.0	1447.71	1441.96	1453.10	1458.51
γ 26.0	1432.29	1425.96	1438.21	1443.57
γ 27.0	1415.81	1409.45	1422.55	1428.61
γ 28.0	1398.91	1393.30	1406.84	1413.04
γ 29.0	1382.33	1376.22	1390.22	1396.96
γ 30.0	1364.53	1359.01	1373.10	1380.84
γ 31.0	1346.81	1340.73	1356.23	1363.70
γ 32.0	1328.02	1321.81	1338.11	1346.04
γ 33.0	1308.91	1303.32	1319.59	1328.63
γ 34.0	1290.30	1284.00	1301.47	1310.44
γ 35.0	1270.21	1264.31	1282.27	1291.67
γ 36.0	1249.91	1244.75	1262.79	1273.42
γ 37.0	1229.85	1223.88	1243.25	1253.70
γ 38.0	1208.79	1202.83	1222.80	1233.78
γ 39.0	1187.31	1182.12	1202.26	1214.21
γ 40.0	1166.51	1160.54	1182.08	1193.79
γ 41.0	1144.47	1138.72	1160.85	1173.14
γ 42.0	1122.12	1117.23	1139.79	1152.79
γ 43.0	1100.13	1094.65	1117.81	1131.42
γ 44.0	1077.33	1071.71	1095.49	1110.26
γ 45.0	1055.10	1049.41	1073.79	1088.29
γ 46.0	1031.91	1026.35	1051.33	1066.40
γ 47.0	1008.64	1003.72	1028.54	1044.98
γ 48.0	985.74	980.53	1006.12	1022.85
γ 49.0	961.69	956.61	982.97	1000.12
γ 50.0	937.53	932.95	959.41	977.53
γ 51.0	914.01	908.72	936.55	955.50
γ 52.0	889.61	884.61	913.09	932.83

IES Indoor Report

Photometric Filename:TPATPD24DLA-40WB-35K.IES

Candela Tabulation - (Cont.)

V/H	C270.0	C292.5	C315.0	C337.5
γ 53.0	865.05	861.14	889.38	910.97
γ 54.0	841.09	836.39	866.29	888.06
γ 55.0	815.96	811.52	842.13	865.17
γ 56.0	790.87	787.21	818.22	842.65
γ 57.0	766.73	762.02	795.17	818.86
γ 58.0	741.63	736.44	771.36	796.65
γ 59.0	717.22	712.36	748.60	775.21
γ 60.0	691.84	687.55	724.83	752.65
γ 61.0	666.37	662.44	701.20	730.92
γ 62.0	641.68	637.55	678.40	708.86
γ 63.0	616.37	612.92	655.20	687.30
γ 64.0	591.12	589.06	631.98	667.27
γ 65.0	566.70	564.17	609.93	647.22
γ 66.0	541.25	539.38	587.08	627.81
γ 67.0	515.87	515.27	564.17	609.56
γ 68.0	491.47	490.82	542.24	590.88
γ 69.0	466.56	466.63	520.03	572.51
γ 70.0	441.80	443.67	498.46	555.15
γ 71.0	418.07	420.01	478.57	537.15
γ 72.0	393.70	396.57	458.79	518.71
γ 73.0	369.17	373.91	439.89	500.60
γ 74.0	345.60	350.75	420.67	481.62
γ 75.0	321.72	327.92	401.83	462.08
γ 76.0	298.91	306.61	383.98	442.57
γ 77.0	275.73	284.63	365.41	421.09
γ 78.0	252.63	262.88	346.49	398.31
γ 79.0	230.46	242.53	327.47	372.21
γ 80.0	208.24	223.28	307.20	342.88
γ 81.0	186.32	205.52	284.99	310.08
γ 82.0	165.94	187.96	260.46	272.63
γ 83.0	144.94	170.86	231.80	232.85
γ 84.0	124.37	154.03	198.62	193.02
γ 85.0	105.11	134.01	164.16	151.62
γ 86.0	85.75	110.40	127.35	112.92
γ 87.0	67.46	84.34	93.01	77.48
γ 88.0	51.48	56.55	61.09	46.05
γ 89.0	37.30	33.93	35.62	35.65
γ 90.0	32.36	31.97	33.45	34.53
γ 91.0	31.37	31.13	32.58	33.64
γ 92.0	30.46	30.38	31.79	32.87
γ 93.0	29.65	29.65	30.90	32.18
γ 94.0	29.11	29.12	30.25	31.48
γ 95.0	28.34	28.45	29.62	30.93
γ 96.0	27.89	27.93	29.13	30.47
γ 97.0	27.21	27.39	28.41	29.75
γ 98.0	26.74	26.90	28.03	29.32
γ 99.0	26.31	26.46	27.74	28.72

IES Indoor Report

Photometric Filename:TPA TPD24DLA-40WB-35K.IES

Candela Tabulation - (Cont.)

V/H	C270.0	C292.5	C315.0	C337.5
γ 100.0	25.76	25.99	27.08	28.37
γ 101.0	25.17	25.46	26.62	27.99
γ 102.0	24.68	25.15	26.25	27.59
γ 103.0	24.33	24.71	25.95	27.09
γ 104.0	23.97	24.32	25.47	26.58
γ 105.0	23.62	23.95	25.19	26.20
γ 106.0	23.13	23.65	24.69	25.79
γ 107.0	22.67	23.23	24.49	25.39
γ 108.0	22.40	22.78	24.02	24.93
γ 109.0	22.07	22.55	23.66	24.33
γ 110.0	21.61	22.24	23.27	23.97
γ 111.0	21.27	21.95	23.00	23.51
γ 112.0	20.95	21.46	22.45	23.08
γ 113.0	20.74	20.98	22.23	22.70
γ 114.0	20.36	20.71	21.82	22.16
γ 115.0	20.15	20.45	21.40	21.87
γ 116.0	19.84	20.32	21.19	21.58
γ 117.0	19.63	19.97	21.02	21.36
γ 118.0	19.48	19.94	20.62	21.19
γ 119.0	19.30	19.71	20.54	20.94
γ 120.0	19.13	19.56	20.30	20.60
γ 121.0	18.95	19.30	20.22	20.53
γ 122.0	18.96	19.13	20.00	20.36
γ 123.0	18.79	19.14	19.95	20.32
γ 124.0	18.69	18.97	19.74	20.09
γ 125.0	18.69	19.05	19.67	19.90
γ 126.0	18.64	18.97	19.57	19.95
γ 127.0	18.63	18.94	19.49	19.78
γ 128.0	18.59	18.83	19.41	19.77
γ 129.0	18.55	18.79	19.31	19.78
γ 130.0	18.49	18.80	19.39	19.64
γ 131.0	18.59	18.91	19.36	19.68
γ 132.0	18.55	18.99	19.44	19.67
γ 133.0	18.64	18.96	19.31	19.73
γ 134.0	18.49	18.96	19.28	19.65
γ 135.0	18.58	19.02	19.39	19.64
γ 136.0	18.58	18.90	19.30	19.57
γ 137.0	18.73	19.04	19.38	19.64
γ 138.0	18.72	18.98	19.26	19.72
γ 139.0	18.68	19.09	19.41	19.72
γ 140.0	18.91	19.07	19.45	19.62
γ 141.0	18.95	19.17	19.50	19.77
γ 142.0	19.00	19.20	19.55	19.78
γ 143.0	19.02	19.35	19.65	19.78
γ 144.0	19.12	19.42	19.76	19.93
γ 145.0	19.17	19.57	19.92	19.77
γ 146.0	19.33	19.64	19.90	19.88

IES Indoor Report

Photometric Filename:TPA TPD24DLA-40WB-35K.IES

Candela Tabulation - (Cont.)

V/H	C270.0	C292.5	C315.0	C337.5
γ 147.0	19.37	19.70	19.92	19.98
γ 148.0	19.36	19.78	20.06	20.02
γ 149.0	19.49	19.80	20.07	20.09
γ 150.0	19.64	19.94	20.13	20.17
γ 151.0	19.58	20.07	20.15	20.30
γ 152.0	19.73	19.99	20.20	20.28
γ 153.0	19.80	20.18	20.31	20.33
γ 154.0	19.75	20.23	20.30	20.36
γ 155.0	19.93	20.26	20.42	20.44
γ 156.0	20.04	20.29	20.54	20.35
γ 157.0	20.18	20.42	20.50	20.47
γ 158.0	20.23	20.57	20.56	20.55
γ 159.0	20.30	20.53	20.64	20.63
γ 160.0	20.29	20.67	20.74	20.69
γ 161.0	20.34	20.66	20.70	20.67
γ 162.0	20.49	20.74	20.80	20.79
γ 163.0	20.51	20.71	20.75	20.76
γ 164.0	20.73	20.70	20.90	20.81
γ 165.0	20.64	20.79	20.88	20.76
γ 166.0	20.70	20.88	20.97	20.85
γ 167.0	20.86	20.97	20.96	20.90
γ 168.0	20.84	21.01	21.00	20.99
γ 169.0	20.95	21.01	21.00	21.00
γ 170.0	21.07	21.09	21.07	21.16
γ 171.0	21.09	21.17	21.08	21.00
γ 172.0	21.14	21.15	21.09	21.02
γ 173.0	21.23	21.25	21.20	21.03
γ 174.0	21.30	21.19	21.29	21.06
γ 175.0	21.28	21.23	21.21	21.08
γ 176.0	21.24	21.32	21.27	21.20
γ 177.0	21.19	21.26	21.35	21.12
γ 178.0	21.45	21.43	21.35	21.16
γ 179.0	21.36	21.35	21.28	21.17
γ 180.0	21.21	21.21	21.21	21.21
