

LIGHT SOLUTIONS APPLICATION GUIDE

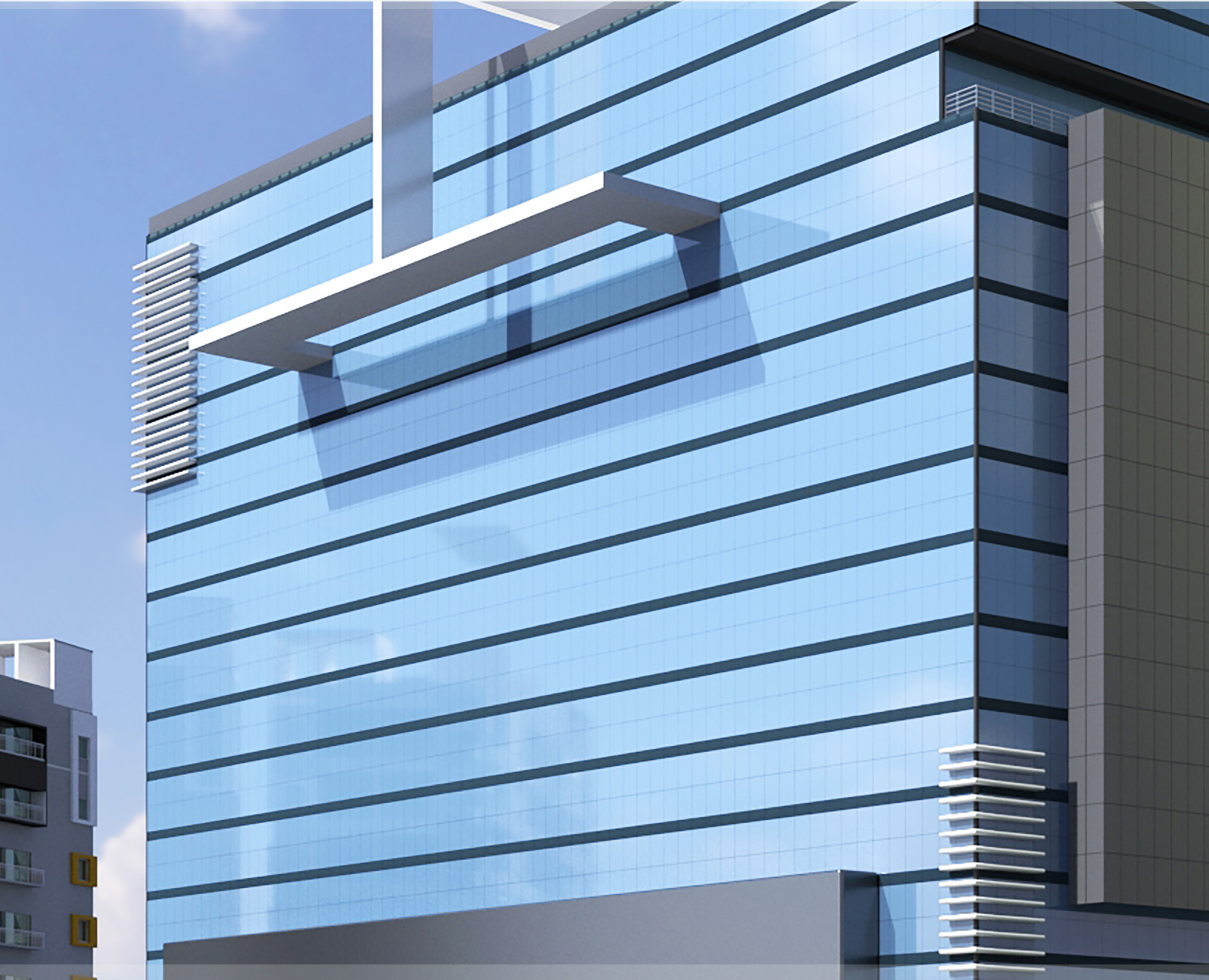

CONTROLS & SOFTWARE



It's easy with Keilton+autani. Quickly integrate lighting with advanced lighting controls that you can commission from a cell phone or tablet. Immediately see the results of your changes.

Measure, report, control, and optimize your energy use in a single building or across multiple facilities. Generate energy savings automatically year after year. Enhance the comfort and productivity of building occupants. That's the power of Autani.

One Platform, Complete Visibility

The Autani platform delivers a unified dashboard for your entire building automation ecosystem. Our solutions readily integrate with your existing infrastructure to provide:

- Granular monitoring and control with standalone sensor solutions
- Local room-based systems for gateway-free control
- Networked building management systems
- Global enterprise-grade analytics across portfolios

This enables consolidated visibility and control for smarter, more efficient operations. Our scalable approach allows you to start small and seamlessly expand capabilities as needs grow.

Whether managing a single site or a global portfolio, the Autani platform empowers you with actionable insights to optimize comfort, occupancy, maintenance, and energy usage across your built environment. It is the foundation for unified, intelligent building and energy management.



Contents

Introduction to Autani	
Making Your Building Smarter	4
Wired and Wireless System Integration	6
Energy Saving Strategies	8
Codes and Compliance	10
Sequence of Operation: Office Building Applications	12
Sequence of Operation: Demand Response	14
Tiers 1-4: Four Levels of Building Controls	16
Main Products - List by Products	18
Sensors - List by Model	20
Quick Fit Connectors for Rapid Installation	23
Eco Sensor Line – Recommended Configurations	23
CAT 5 Cables - Preconfigured Lengths	25
Building Network Overview	26
Building Types and Applications	28
Open Office - Zone Control	30
Open Office - Luminaire Level Lighting Control (LLLC)	32
Small Office / Storage / Utility - Occupancy Switch	34
Office - Zone Control	36
Office - Luminaire Level Lighting Control (LLLC)	38
Warehouse / Highbay	40
Outdoor	42
Restroom	44
Emergency - Hallway	46
Conference Room - Zone Control	48
Conference Room - Luminaire Level Lighting Control (LLLC)	50
Classroom - Zone Control	52
Classroom - Luminaire Level Lighting Control (LLLC)	54
Plug Load	56

Making Your Building Smarter

Here is what you need to know

Make Your Building Smarter with Autani

The Autani platform integrates lighting, HVAC and other systems into a wireless digital backbone. Advanced sensors and analytics provide the data foundation to optimize operations and align with business goals.

Keilton+autani makes your existing building smarter by integrating the Keilton lighting controls platform with Autani's proven energy management, reporting, and control platform. Our systems are flexible, adaptable, and resilient, aligning your business goals with the operational demands of your building infrastructure, which ultimately impacts your bottom line.

Key benefits:

- Reduced expenses through energy savings and efficient operations
- Enhanced comfort and air quality
- Proactive maintenance for safety
- Visibility into occupancy patterns and space utilization
- Customer traffic insights to inform staffing

Real-time adaptation of building controls improves decision making across:

- Energy management
- Asset maintenance
- Space planning
- Customer engagement

By making buildings smarter, Autani builds resilience into operations. This allows organizations to reduce costs, mitigate risks, and connect infrastructure performance to strategic objectives.



Building Automation and utility savings is just the beginning of what Autani can bring to your business. Smart devices and controls unlock business insights that can have far greater savings implications.



Wired and Wireless System Integration



Autani's platform can integrate multiple ecosystems, allowing it to easily adapt to a building with existing protocols.

The Benefits of a Wireless System

In our modern wireless world, installing new wiring can be costly and ineffective. Wireless systems help both the installer and building owner:

1. Avoid the need to run wiring and conduit through multiple walls and ceilings in adjacent rooms.
2. Keep the work below the ceiling space by using light fixtures with embedded controllers. This minimizes the unknowns in any building and the potential for asbestos problems in pre-1980s buildings.
3. Maintain historical and aesthetically pleasing architectural spaces.
4. Provide flexibility where occupants' needs change. When walls move or the floor layout changes, the system can be recommissioned without the need for new controls equipment or rewiring.
5. Scale the system as needed without changing infrastructure.

Locally Wired, Globally Wireless Connectivity

The existing wired ecosystem within a room can be integrated with new wireless devices.

1. Wireless controllers, sensors, and switches form a wireless control mesh instead of the old paradigm of running new wires to every device.
2. Keilton+autani devices operate as standalone units for the purposes of switching and local control. Devices are connected to the Energy Manager for schedule updates and energy curtailments, where centralized control is desired.
3. BACnet integration allows for import/export with other building management systems to meet owner requirements and provide one point for system-wide schedule changes.

System Security

The Keilton+autani wireless network has features to protect the integrity of the wireless system, keep people out that shouldn't have access, and set different tiers of credentials and levels of accessibility to limit what can be done by those who need access.

1. Unauthorized devices are quarantined from the mesh network, and new devices cannot join the network unless granted access by the administrator. Keilton+autani controls use advanced encryption technology to prevent access to unauthorized devices.
2. Autani's EnergyCenter platform supports Role-Based Access, allowing user logins to be associated with the appropriate access levels needed by different types of users. Roles are customizable and support access levels such as viewing read-only reports, scheduling updates, and commissioning additional equipment.



Keilton+autani's networks have been designed with security in mind.

Bluetooth Security

The Bluetooth security model includes five distinct security features: pairing, bonding, device authentication, encryption and message integrity.

1. Pairing: the process for creating one or more shared secret keys.
2. Bonding: the act of storing the keys created during pairing for use in subsequent connections in order to form a trusted device pair.
3. Device authentication: verification that the two devices have the same keys.
4. Encryption: message confidentiality
5. Message integrity: protects against message forgeries.

BR/EDR Secure Simple Pairing

The primary goal of Secure Simple Pairing is to simplify the pairing procedure for the user. Secondary goals are to maintain or improve the security in Bluetooth wireless technology. Since high levels of security and ease-of-use are often at opposite ends of the spectrum in many technologies and products, much care has been taken to maximize security while minimizing complexity from the end user's point of view.

Secure Connections Only Mode

When a device requires that only FIPS-approved algorithms are used on the BR/EDR physical transport, it should enter Secure Connections Only Mode on the BR/EDR physical transport. Secure Connections Only Mode is sometimes called a "FIPS Mode." This mode should be used when it is more important for a device to have high security than it is for it to maintain backwards compatibility with devices that do not support Secure Connections. The Host will enforce that the P-256 elliptic curve is used during pairing, the secure authentication sequences are used, and AES-CCM is used for encryption.

LE Security

The pairing mechanisms introduced in Bluetooth Core Specification v4.0 (known as LE Legacy Pairing) have some differences in security aspects with respect to BR/EDR security features such as Secure Simple Pairing. The association models are similar to BR/EDR Secure Simple Pairing from the user perspective and have the same names but have differences in the quality of the protection provided.

AMP Security

AMP security does not change the user experience because it utilizes the same Secure Simple Pairing association models that were introduced in the Bluetooth 2.1 + EDR Core Specification. From the user's point of view, all radios are "paired" in one process.

Key Generation Between BR/EDR and LE Physical Transports

When two BR/EDR/LE devices support Secure Connections over both transports, keys for both transports may be generated during a single pairing procedure. The ability to convert keys from one transport to the other prevents the need to pair twice, thus enabling a better user experience.

Energy Saving Strategies

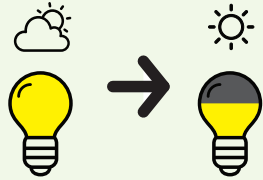

Daylight Harvesting
Dim indoor and outdoor lighting when daylight is available.

5-25% LIGHTING SAVINGS

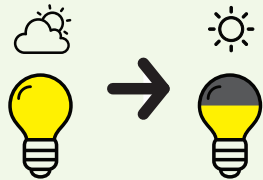

Local Dimming Control
Permit occupants to lower the light level below the high-end trim for comfort and additional savings.

10-20% LIGHTING SAVINGS

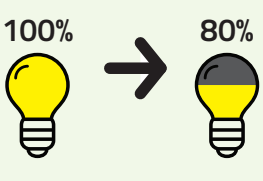

High-End Trim | Institutional Tuning
Set the maximum light level based on customer requirements in each space to prevent overlighting.

10-30% LIGHTING SAVINGS



System Metering and Monitoring
Add revenue grade metering for measurement, verification, and system monitoring to identify changes in energy performance.

REAL TIME KNOWLEDGE

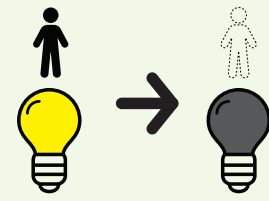

Occupancy / Vacancy Sensing
Turn lights on when occupants are in a space and off when they vacate the space.

10-40% LIGHTING SAVINGS

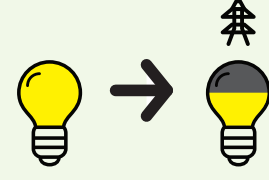

Demand Management
Manage lighting and HVAC electrical loads to limit ratchet charges and periods of peak demand pricing.

10-40% DURING PEAK PERIODS



HVAC Control
Manage smart thermostats and sensors to implement temperature setback of HVAC equipment based upon occupancy or timeclock.

10-25% ELECTRIC COOLING AND HEATING SAVINGS

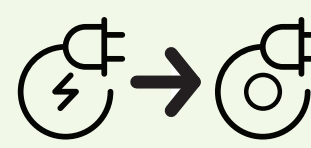

Plug Load Control
Manage control of select plug loads for Energy Code Compliance and the elimination of phantom loads when the building is not occupied.

10-50% CONNECTED ELECTRIC LOAD SAVINGS



Automatic Scheduling & Timeclock
Implement automatic shut off of indoor and outdoor lighting systems, including astronomical timeclock for outdoor lights to maximize energy savings.

10-25% LIGHTING SAVINGS

Codes and Compliance

Unlock Savings and Value with Autani's EnergyCenter Software

The key to achieving maximum energy and operational savings associated with building energy codes is through compliance verification and ongoing systems monitoring. Autani's EnergyCenter software easily allows a commissioning agent or acceptance tester to verify that component programming and settings comply with your local energy standard requirements. When a device or system is not in compliance, the settings can be modified in the software to verify code compliance. Ongoing system monitoring and reporting ensure the integrity of executing energy saving strategies.

Energy Code Basics

Energy codes and standards set minimum efficiency requirements for new and renovated buildings. ASHRAE 90.1-16, 2019 IECC – Prescriptive, Title 24 and 2021 IECC – Performance are commonly referenced. **For additional codes and compliance information, please visit www.autani.com/compliance.** Autani's EnergyCenter software can help you establish your local compliance with CA Title 24 and other state and local code requirements.

2021 International Energy Conservation Code Highlighted Sections

- Section C405 – Electrical Power and Lighting Systems
 - › C405.2 Lighting Controls (Mandatory)
 - ›› C405.2.1 Occupant Sensor Controls
 - ›› C405.2.2 Time-Switch Controls
 - ›› C405.2.3 Daylight-Responsive Controls
 - ›› C405.2.4 Specific Application Controls
 - ›› C405.2.5 Manual Controls
 - ›› C405.2.6 Exterior Lighting Controls
 - › C405.3 – Interior Lighting Power Requirements (Prescriptive)
 - › C405.5 – Exterior Lighting (Mandatory)
- Section C504 – Repairs

When Do Lighting and Power Requirements Apply?

1. Original installed systems in a new building, addition, or tenant build-out.
2. Altering or retrofitting more than 10% of the existing luminaires in a space and installed interior lighting power is not increased.
3. Changes in occupancy that increase energy consumption.
4. Changes in occupancy that require a lower lighting power density (LPD) as shown in the code LPD tables.

Note: Always check your local code to verify requirements for all retrofit and renovation work. Additionally, see 2021 IECC Section C405.3.1 Total Connected Interior Lighting Power for areas excluded from LPD requirements.

Functional Testing

Prior to final inspection and project completion, a qualified design professional should provide evidence that the lighting controls systems and thermostatic controls systems have been tested and performance has been verified to ensure:

- Control hardware and software are calibrated, adjusted, programmed, and working to meet or exceed code requirements as specified per the construction documents or contractual performance guarantee.
- All manufacturer installation instructions, equipment cut sheets, and other supporting documents have been aggregated for the owner.
- All monitoring and alerts have been set up for ongoing performance verification.

Sequence of Operation: Office Building Applications

Occupancy / Vacancy Sensor Applications

Per 2021 IECC C405.2.1

1. When lights are on, all non-emergency lights automatically turn off when occupancy is not detected by the occupancy sensor within [15 minutes].
2. If sensor has turned lights off and occupancy is detected within [60 seconds], then lights return to the last lighting level.
3. When lights are off, lights set to [manual on] or [automatic on set to [50%] power]. Per code, areas where manual-on operation would endanger the safety or security of the room or building occupants shall be full automatic-on.
4. Operating hours logged and reported in the EnergyCenter software for system learning and alerts. If lights are on for [60 minutes] during afterhours operation [9 PM], an alert shall be sent.

Daylight Sensor Applications

Per 2021 IECC C405.2.3 and C406.4

1. When the space is occupied, the daylight sensor automatically reduces power and dims the light fixtures to maintain a consistent [30] foot candle setting. The maximum [8] fixtures associated within the daylighting zone programmed to not exceed the maximum light level established by the daylight sensor.
2. Set dimming range from a maximum dimming level [100%] of the high-end trim setpoint to a minimum dimming level [10%] to avoid confusion among occupants. Note: Lights can be turned off if occupants are aware of the operations and energy savings benefits.

Open Area Sensor Applications

Per 2022 Title 24 Section 130.1

1. In open areas, lighting control zones must be set up in separate zones less than [600] sqft.
2. When the entire open area is unoccupied for [20 minutes], the lights in the entire area must transition to off.
3. When only some control zones are occupied, the unoccupied zones must drop down at least [80%] of full power within [20 minutes].

Wireless Switch / Dimmer Lighting Control

Per 2021 IECC C405.2.2.2

1. Allow local dimming from [80%] high-end trim to [0%] in the room.
2. Support on/off switching.

Lighting and Thermostat Timeclock Control & Scheduling

Per 2021 IECC C405.2.3 and C406.4

1. Set high-end trim/institutional tuning maximum light level to [80%].
2. EnergyCenter software timeclock turns interior lights on to [50%] light level during scheduled normal hours of operation.
3. During scheduled unoccupied hours, all nonemergency interior lighting systems are [swept off] or [dimmed to [30%]]. If occupancy is detected, the lights in the occupied rooms remain on and the occupancy will be logged.
4. Local manual overrides set to allow lights to remain on for [2 hours] maximum.
5. Exterior lights turned on/off via an astronomical timeclock. Lights turn on to [80%] [15 minutes] before sunset, and turn off [15 minutes] after sunrise.
6. Exterior lights grouped to enable automatic dimming from [100%] maximum to a minimum of [50%] between the hours of [12 AM] and [6 AM] with a manual override to full on. See IECC C405.2.6.3
7. Timeclock schedule to automatically setback room thermostats [5 degrees F] during unoccupied hours. Timeclock to reset thermostats to occupied mode [1 hour] prior to normal occupied operations.

Electrical Receptacle / Smart Outlet Plug Load Control

Per ASHRAE 90.1-2019, Section 8.4

1. Controlled electrical receptacles in a space to be automatically turned off within [20 minutes] when occupancy is not detected by the associated occupancy sensor.
2. During scheduled occupied hours, electrical receptacles to be automatic on within [30 seconds] when occupancy is detected.
3. During scheduled unoccupied hours, all controlled electrical receptacles are [swept off]. If occupancy is detected, the controlled receptacles in the occupied rooms remain on.
4. During scheduled unoccupied hours, electrical receptacles to be automatic on with a [5 minute delay] when occupancy is detected.
5. If electrical load exceeds [10 amps] at any receptacle, an alert shall be sent with location of the excessive load and time of occurrence.

Note: These sequences of operation are for general information purposes only, and are provided without any warranty as to accuracy, completeness, or otherwise. The user should read the applicable code requirements for their specific project requirements, and should consult with a professional engineer or other competent advisor to comply with local code requirements.

Sequence of Operation: Demand Response

Having the ability to manage your electricity consumption can allow a building owner/operator to reduce electrical consumption during periods of real-time pricing, critical-peak pricing, or time-of-use tariffs that may be charged by the local electric utility. Moreover, some utilities may offer incentive-based demand response programs to pay the building owner/operator if the building's electrical consumption can be reduced during certain periods of time throughout the year.

Participation in a demand response program may generate monthly incentive payments. Having an ability to reduce electrical consumption and potentially shift some of the electrical load, such as precooling the building, can positively impact the bottom line.

Even if your utility does not currently charge for real-time or critical-peak pricing, almost all have a ratchet charge that you pay on a 12-month basis just so the utility can "reserve" power for you. Autani's EnergyCenter helps reduce your risk and exposure to these higher utility charges.



Demand response programs can be initiated automatically through EnergyCenter and reward customers who voluntarily reduce their energy use during peak demand events.



Demand Response / Electrical Load Shedding

Per 2021 IECC C406.4

Upon notification of a demand response signal, the building [automatically] or [manually] implements the following during the entire duration of the event via the EnergyCenter software:

1. Maximum light level set to [50%] in all essential spaces.
2. Non-essential space lighting is turned off.
3. Non-essential controlled electrical receptacles are turned off.

4. Essential controlled electrical receptacles are monitored with alerts set at [10 amps] to notify facilities management of excessive loads and their location.
5. Electrical meters connected through BACnet will report electrical load consumption and provide status alerts every [15 minutes] via the EnergyCenter software during the event.

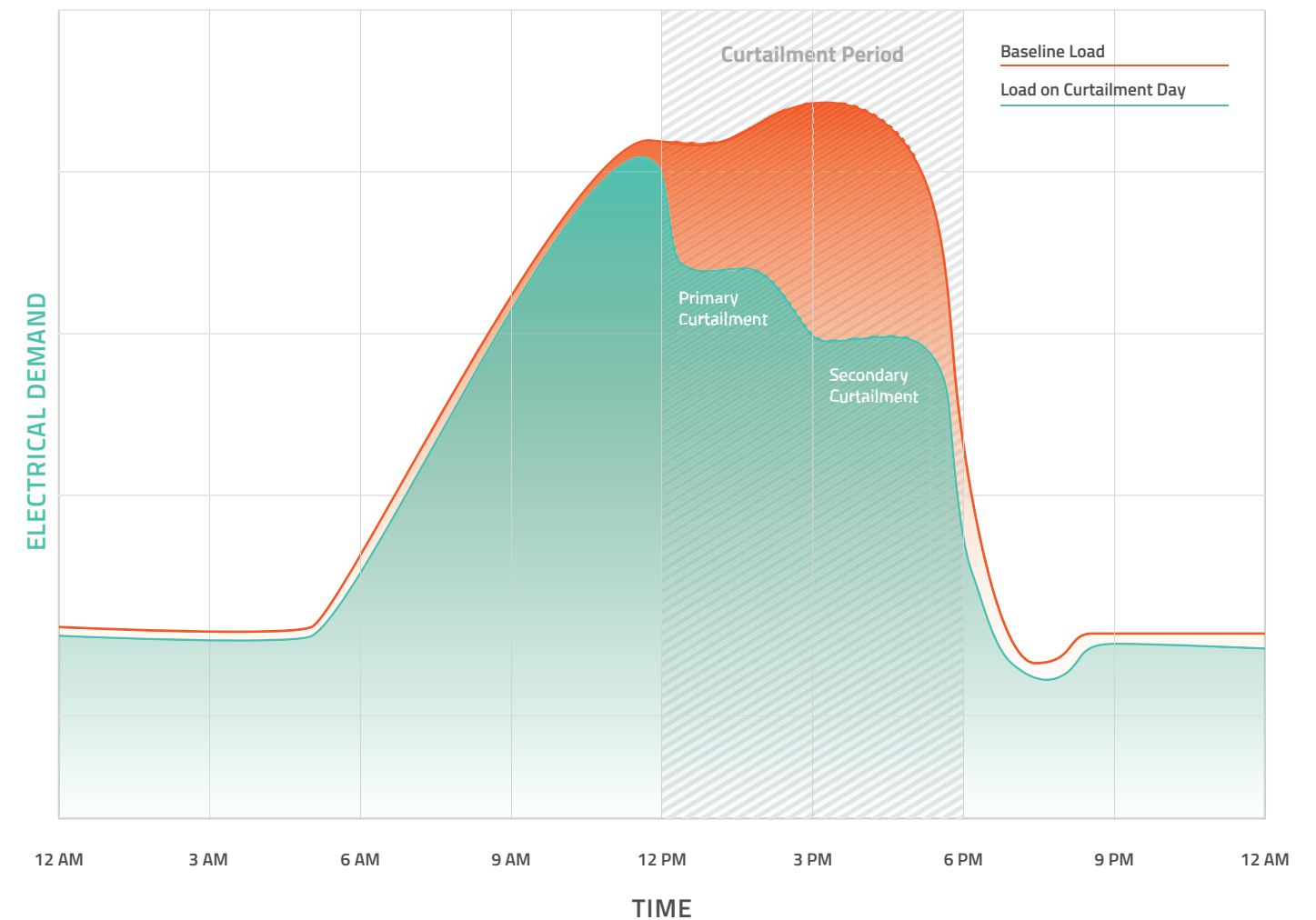

Tiers 1-4: Four Levels of Building Controls

Scalable, Proven Building Controls

With options to scale up from standalone wired systems to fully networked buildings and analytics platforms, we provide the right controls solution. Our spectrum of localized, networked, centralized, and AI-driven enterprise systems meets needs today and evolves tomorrow.

TIER 4
INSIGHT

Keilton
+ autani

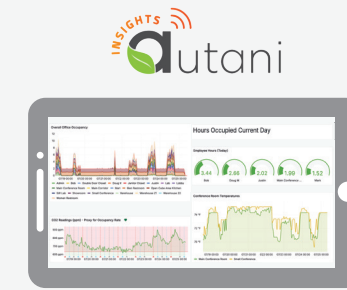

TIER 3
NETWORKED

Keilton
+ autani

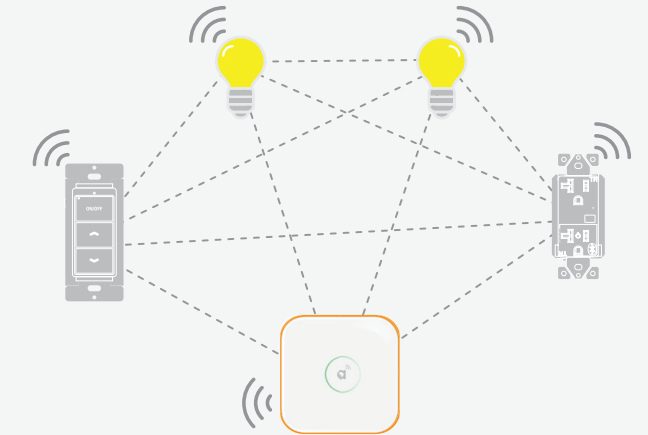
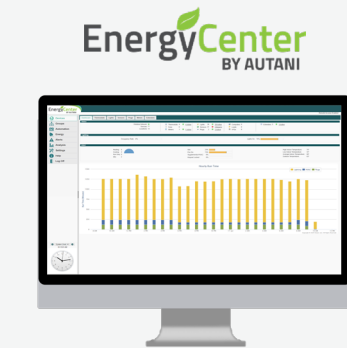

TIER 2
LOCAL ROOM-BASED

Keilton
+ autani

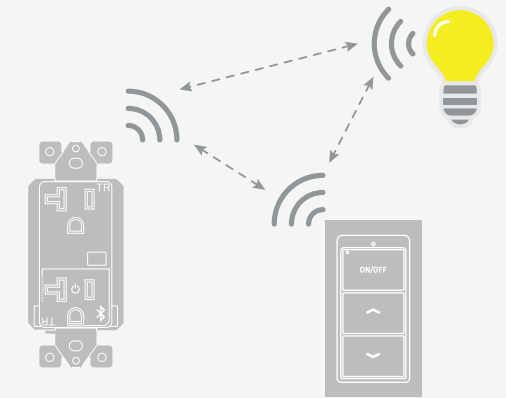

TIER 1
BASIC, STANDALONE

Keilton
Basic

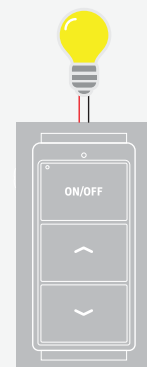

Main Products - List by Products

AC POWERED CONTROLLERS

PIR OCCUPANCY & DAYLIGHTING SENSOR



FIXTURE ADAPTOR

PIR OCCUPANCY & DAYLIGHTING SENSOR

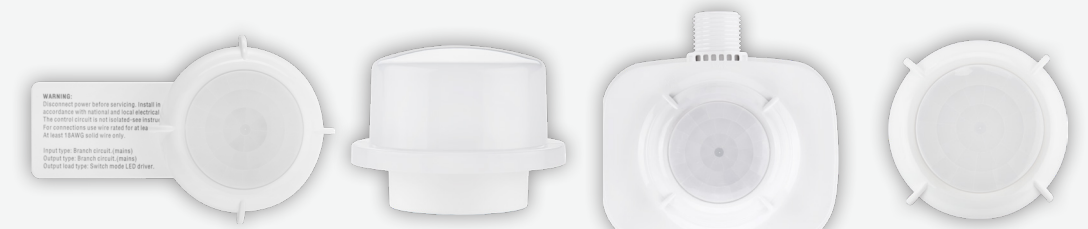

FIXTURE CONTROLLER

AC POWERED AND SENSOR READY



WALL STATION

BATTERY POWERED & REMOTE CONTROLLER



INTEGRATED DC SENSOR

PIR OCCUPANCY & DAYLIGHT HARVESTING



USB GATEWAY LITE & 485 GATEWAY

ENERGY MONITORING, RTC, CR05



Sensors - List by Model

INTEGRATED SENSORS

EFS104.B1 External High Bay Sensor



- 120-277VAC input
- Connects with 1/2" standard knockout
- Daylight Harvesting
- Bluetooth PIR analog sensor with Algo² algorithm to maximize detection without false trigger
- Replaceable lens options

NOTE: Lens sold separately

EFS106-AUX-W.B2 Long Range High Bay Sensor



- 3.5mm audio jack connector
- Enhanced long-range antenna with up to 328 ft Bluetooth transmission range
- Plug and Play 12V sensor with integrated connector
- Bluetooth PIR analog sensor with Algo² algorithm to maximize detection without false trigger
- Replaceable lens options

NOTE: Lens sold separately

EFS106-AUX.B1 Plug and Play High Bay Long-Range Sensor



- 3.5mm audio jack connector
- Enhanced long-range antenna with up to 328 ft Bluetooth transmission range
- IP66
- Plug and Play 12V sensor with integrated connector
- Bluetooth PIR analog sensor with Algo² algorithm to maximize detection without false trigger
- Replaceable lens options

NOTE: Lens sold separately

IFS105SE.B1 Integrated Round 12V Sensor



- 12VDC input
- Integrated wiring terminal block
- PIR Sensor
- Daylight Harvesting
- Easy installation
- Digital sensor technology designed for low bay applications

NOTE: Lens sold separately

CEILING MOUNT SENSORS

BCS107.A0 Battery Powered Ceiling Sensor



- PIR + Daylight Harvesting
- 600 sq ft room coverage
- Occupancy / vacancy enabled
- Powered by a single CR123A 3V battery
- 10 years of estimated battery life
- Easy installation with multiple mounting options

CS107D.B1 Line Voltage Occupancy Sensor



- 120-277VAC input
- 600 sq ft room coverage
- Daylight Harvesting
- Dual-tech PIR + Ultrasonic technology provides high accuracy and wide coverage
- Wireless Bluetooth connection to other Keilton+autani devices

ACCESSORIES

HBL3 High Bay Lens

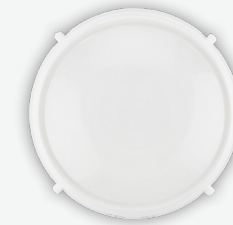

- Designed for 20 to 50 ft mounting heights
- IP40
- Powerful high bay lens with 360° coverage
- Optimized for open area and aisleway coverage in high bay applications
- Multi-cell, multi-tier Fresnel lens with high density coverage patterns

WHBL1-2-B Wet Location High Bay Lens



- Designed for 20 to 40 ft mounting heights
- IP66
- Powerful high bay lens with 360° coverage
- Optimized for open area and aisleway coverage in high bay applications
- Multi-cell, multi-tier Fresnel lens with high density coverage patterns

RC02 Recessed Mounting Adaptor



- Recessed ceiling adaptor designed for easy installation of ceiling sensor IFS105E.A0 series

Eco Sensor Line of Retrofit Sensors

ALL IN ONE

The Eco Sensor product line combines wireless controllers with simple, easy to connect sensors in a retrofit friendly installation form-factor. Whatever your retrofit solution requires in terms of mounting hardware and power options, the Eco Sensor Line can provide a solution for your facility and fixtures of choice. The Eco Sensor line includes quick-fit connectors for rapid installation in the field.

LLLC - Luminaire Level Lighting Control Solutions

FIXTURE INSTALLED PRODUCTS

LLLC / FIXTURE BASED SENSORS



IFS105E SERIES
PIR Sensor for Fixture KO or Ceiling Mount Install



MWS105E SERIES
Microwave / Behind Lens Sensor



1-10V DIMMING APPLICATIONS

For relay-based solutions (6 amp)



PPA102S SERIES
Line voltage lighting controller with integrated relay, 1/2" KO Mounted

0-10V DIM TO OFF APPLICATIONS

For Fixtures with 12VDC Power



FA102 SERIES
12VDC Powered dimming controller

OR

Zone Based Solutions

AREA SENSOR PRODUCTS

20A RELAY + DIMMING CONTROLLER

For area-based control (20 amp)



PPA104S SERIES
Line voltage power pack with relay, 1/2" KO Mounted



DAISY CHAIN ADAPTOR



RTP - RJ45 / PH2.0 ADAPTOR
Daisy chain up to 20 sensors to a single controller



ONE OR MANY AREA BASED SENSORS



EFS107E SERIES
Dual Tech (PIR + US) Sensor for Ceiling Mount Install

OR



MS107E SERIES
Dual Tech (PIR + US) Sensor for Wall Mount Install

The Eco Sensor LLLC solution has pre-wired solutions to fit virtually any fixture. Pre-installed connectors support rapid retrofit installations of controls

The Eco Sensor zone-based solution uses CAT5 cabling to rapidly connect area controllers and one or more daisy chained sensors. Cables can be purchased in pre-configured lengths to speed up installation time.

Quick Fit Connectors for Rapid Installation

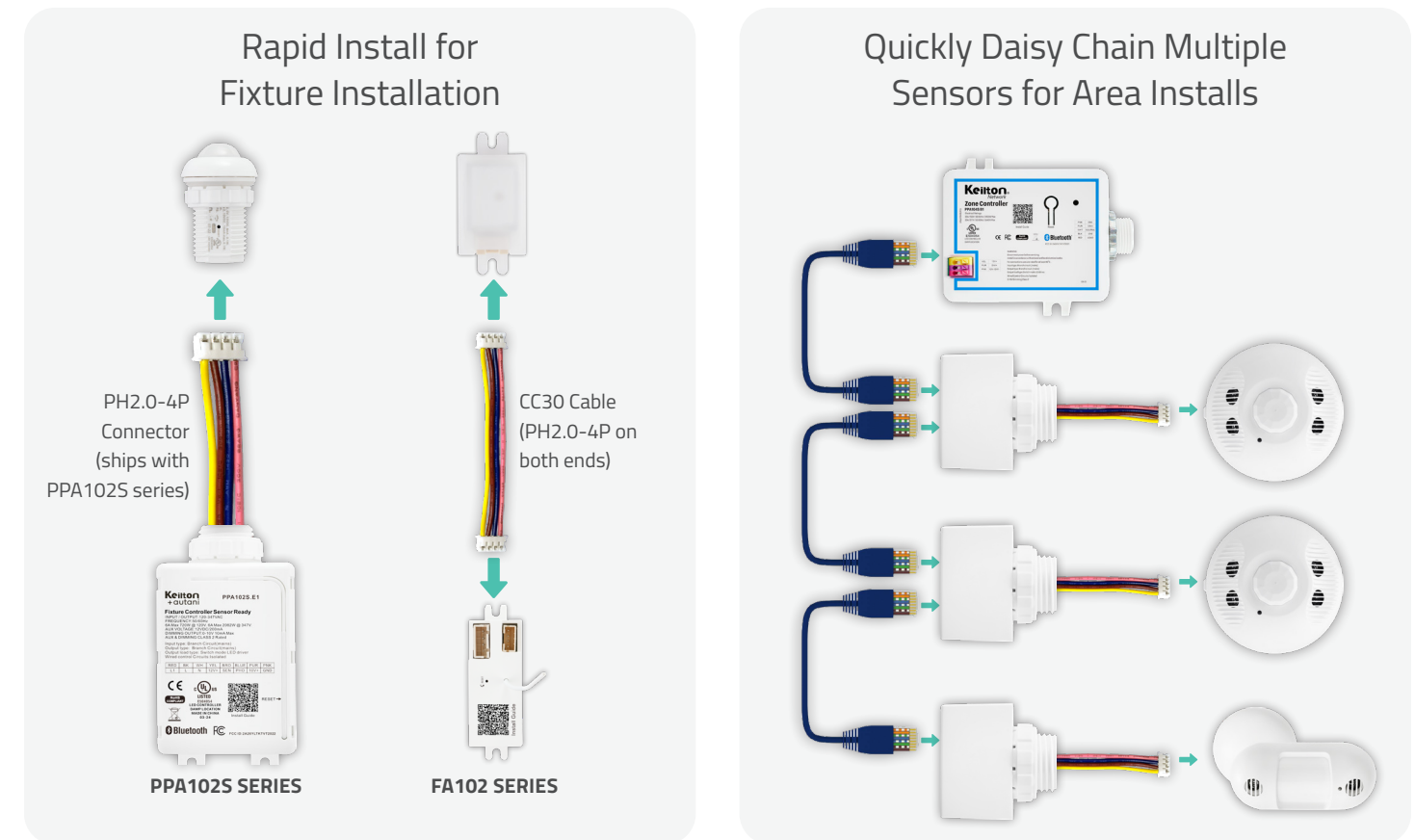

Eco Sensor Line – Recommended Configurations

Application	Mount Options	Sensor	Recommended Controller	Connection Type
LLLC Retrofit PIR Sensor	Retrofit 1/2" fixture knockout or ceiling tile install (requires RC03 adaptor)	IFS105E.A0	PPA102A.C1 - Power Pack with relay for 1-10V dimming retrofit applications FA102.C2 - Low Voltage controller for 0-10V (dim to off) retrofit applications	Use PH2.0 connector coming out of the power pack nipple
LLLC Retrofit Microwave Sensor	Behind fixture lens install	MWS105.A0	PPA102A.B1 - Power Pack with relay for 1-10V dimming retrofit applications FA102.B2 - Low Voltage controller for 0-10V (dim to off) retrofit applications	Use PH2.0 connector coming out of the power pack nipple
Zone Control Ceiling Mount / Dual Tech	Retrofit ceiling mount install	EFS107E.A0	PPA104S.B1 + RTP Adaptor	Use RJ45 jack and CAT5 cables to connect to one or many sensors through RTP (daisy chaining adaptor)
Zone Control Wall Mount / Hallway Dual Tech	Retrofit wall mount install	MS107E.A0	PPA104S.B1 + RTP Adaptor	Use RJ45 jack and CAT5 cables to connect to one or many sensors through RTP (daisy chaining adaptor)

Eco Sensor Line of Retrofit Sensors

CABLES

4 WIRE CONNECTORS

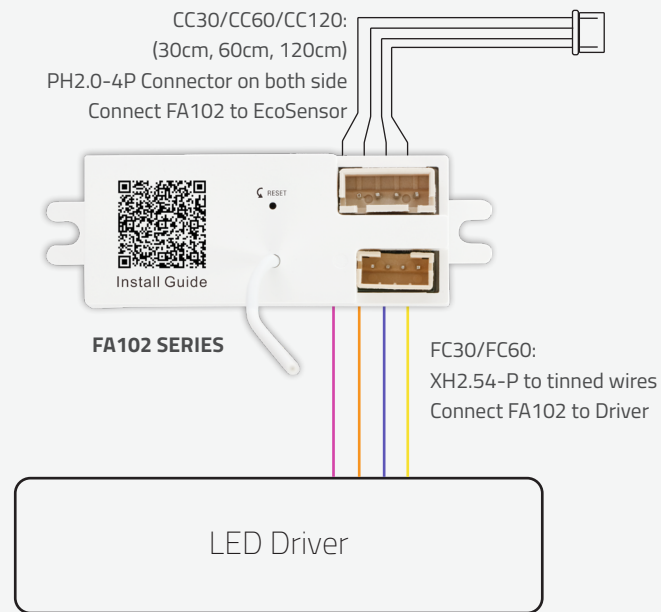

CAT 5 Cables - Preconfigured Lengths

CAT-R10 - 10' length of CAT5 cable with RJ45 connectors
CAT-R25 - 25' length of CAT5 cable with RJ45 connectors
CAT-R50 - 50' length of CAT5 cable with RJ45 connectors

CC30 - 30cm length of 4-wire cable with PH2.0-4P connector on both sides (connect sensor to FA102)
CC60 - 60cm length of 4-wire cable with PH2.0-4P connector on both sides (connect sensor to FA102)
CC120 - 120cm length of 4-wire cable with PH2.0-4P connector on both sides (connect sensor to FA102)

FC30 - 30cm length of 4-wire cable with PH2.0-4P connector on one side and tinned wire connection on the other (connect FA102 to driver)
FC60 - 60cm length of 4-wire cable with PH2.0-4P connector on one side and tinned wire connection on the other (connect FA102 to driver)

CAT 5 Cables - Preconfigured Lengths



CAT-R10 - 10' length of CAT5 cable with RJ45 connectors



CAT-R25 - 25' length of CAT5 cable with RJ45 connectors



CAT-R50 - 50' length of CAT5 cable with RJ45 connectors

Building Network Overview

WIRELESS SMART BUILDING BACKBONE VIA INTEGRATED LIGHTING SYSTEMS

Autani's EnergyCenter building management platform upgrades the entire facility, from indoor and outdoor lighting systems to standalone thermostats, with an energy efficient network of user-friendly controls that can be accessed anytime, from anywhere. Autani's wireless mesh network is primarily built from these components. The Autani Manager collects and aggregates data throughout the building, while the CR05s act as wireless gateways within the building. When combined with an RTR, multiple CR05s extend wireless coverage throughout the entire facility.

Product Recommendations



Manager with EnergyCenter Software

Serves as central control hub to distribute programming to all fixtures. Controlled on-site or remotely via EnergyCenter software. If your facility already utilizes a Manager to control indoor lighting, the same Manager can be used to control outdoor lighting.

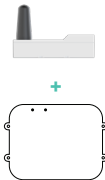

CR05.A0 + RTR.A0

CR05 and RTR devices work in conjunction with the Manager to bring Bluetooth lighting controls into your network.

Additionally, they extend the range of the wireless communications, which is especially useful when bridging between multiple floors or outdoor lights.

Use the RTR and CR05 to position antennas for energy monitoring, offsite schedule changes, and remote monitoring.



EnergyCenter Software and Remote Access



Building Network Overview

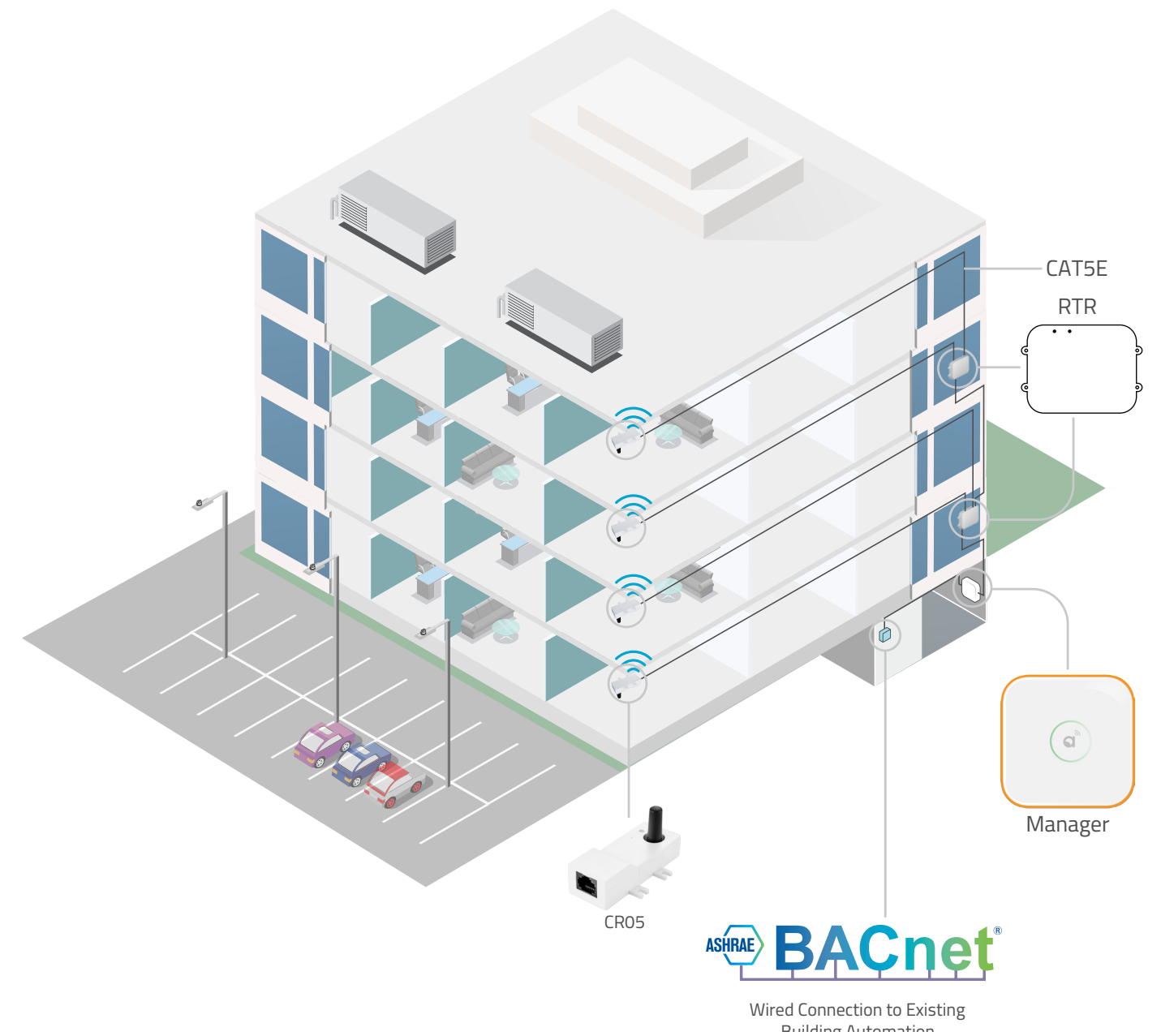

Building Types and Applications

Here is what you
need to know

Open Office - Zone Control

FLEXIBLE AND COMFORTABLE WORK SPACE

Keilton+autani controls create office spaces where occupant comfort and energy savings go hand in hand. Lighting levels can be dynamically adjusted based on occupancy or by using wireless wall switches. Daylight harvesting allows lighting use to be dialed back when exterior daylight enters the space. By zoning lights within the space, savings from daylight harvesting is maximized while maintaining appropriate light levels for occupants. Adding plug load control eliminates phantom power use, increasing energy savings. Energy use within the space can be monitored and controlled via phone or tablet using the Keilton+autani app, or elevate to a Tier 3 solution offering analytics capabilities with the Autani Manager.

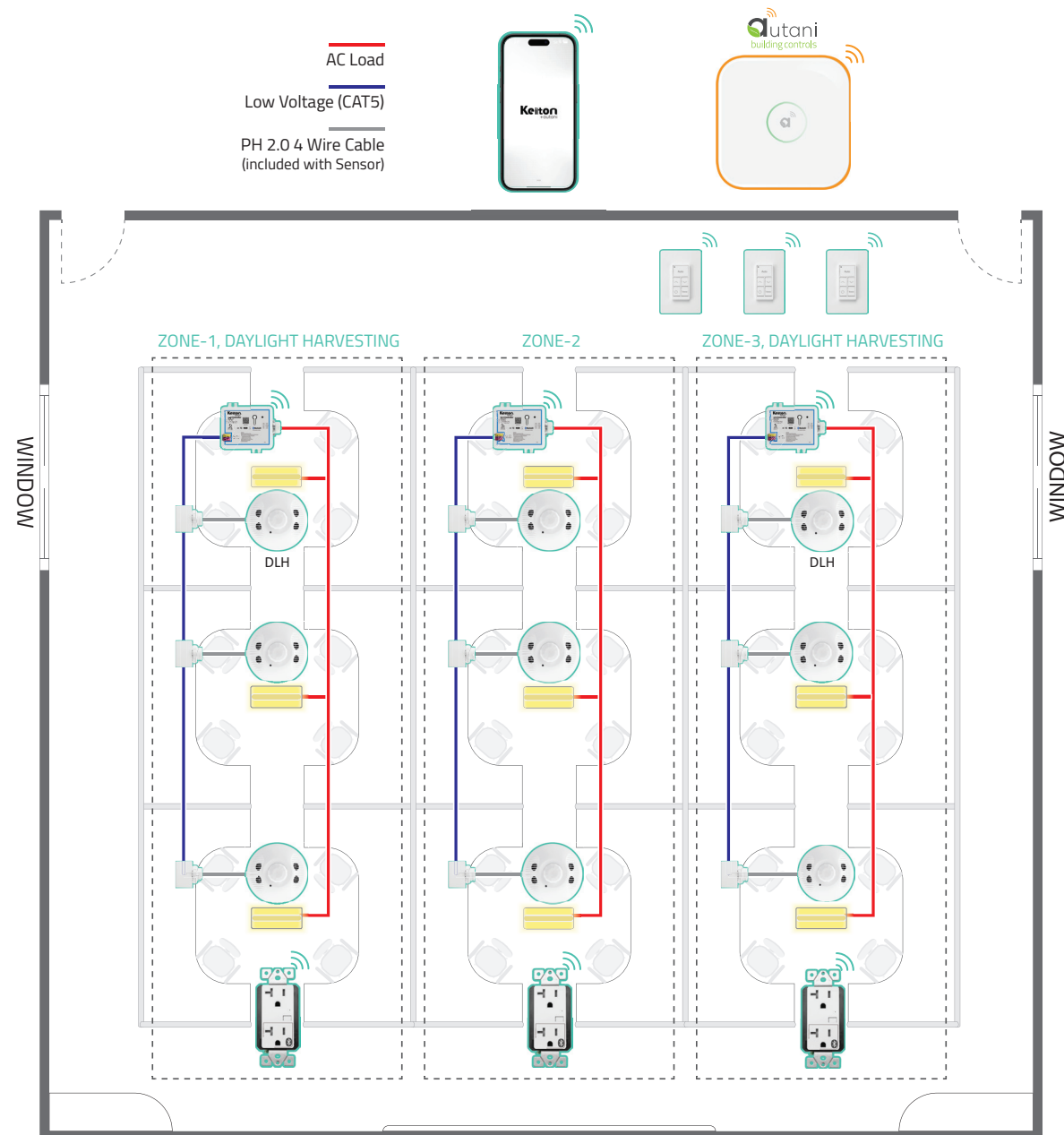

PRODUCT RECOMMENDATIONS

PPA104S.B1 Line Voltage 20A Bluetooth Zone Control

- 120-277VAC input
- Integrated 20A relay
- Output power up to 2,400W (120VAC), 5,540W (277VAC)
- UL Plenum Rated
- 1 HP motor load rated

WP1013.A0 (3 Button) / WP1025.B1 (5 Button) Battery-Powered Bluetooth Wall Switch

- Quick push-button control of Keilton+autani devices via Bluetooth
- Powered by a single CR2032 battery
- Approximately 10 years battery life
- Can be wall-mounted or used as portable remote controller
- Can be linked to a light or light group via the Keilton+autani app

EFS107E.A0 12V Dual-Tech Ceiling Eco Sensor

- 12VDC input
- Powered by power packs (PPA1025x/PPA1045x) and connected with low voltage cable
- 600 sq ft room coverage
- Daylight Harvesting
- Dual-tech PIR + Ultrasonic technology provides high accuracy and wide coverage

RTP - Tee Adaptor

- Connects from RJ45 to PH2.0
- Supports daisy chaining of multiple sensors

NOTE: Only the first device in a daisy chain can be used for daylight harvesting

WF20R.A0 20A Plug Load Bluetooth Controller

- 120VAC
- 20A plug load Bluetooth controller
- Controllable via the Keilton+autani app

Autani Manager

The Autani Manager is the control processor at the heart of the innovative integrated energy management systems powered by EnergyCenter software. The Manager securely coordinates all energy management functions and provides actionable insights.

CR05.A0 + RTR.A0

- CR05 and RTR devices work in conjunction with the Manager to bring Bluetooth lighting controls into your network.
- Bluetooth network per CR05 may not exceed a radius of 100ft
- Bluetooth network per CR05 may not exceed 4 hops wireless mesh

TIER - 03

CONTROL STRATEGIES

Occupancy / Vacancy Sensing

Turn lights on when occupants are in a space and off when they vacate the space. Alternate Functionality: Partial-on and manual-on modes are supported for additional savings and for more stringent local codes.

High-End Trim | Institutional Tuning

Set the maximum light level based on customer requirements in each space to prevent overlighting.

Daylight Harvesting

Dim lighting when daylight is available. Multiple zones are supported where required by code.

Automatic Scheduling & Timeclock*

Automatically dim or shut off lighting based on centrally managed schedules.

*** Requires Autani Manager or CR02-W.A0.**

Demand Response*

Manage lighting and electrical loads per utility requirements during periods of high demand.

*** Requires Autani Manager.**

ESTIMATED TOTAL SAVINGS: 20-50%

Alternative Product Recommendations

BCS107.B1 Battery-Powered Occupancy Sensor

- PIR + Daylight Harvesting
- 600 sq ft room coverage
- Occupancy / vacancy enabled
- Powered by a single CR123A battery
- 10 years of estimated battery life
- Easy installation with multiple mounting options

WP1018A.A0 8-Key Battery-Powered Bluetooth Wall Switch

- Quick push-button control of Keilton+autani devices via Bluetooth
- Powered by two AAA batteries
- Approximately 10 years battery life
- Can be wall-mounted or used as portable remote controller
- Can be linked to a light or light group via the Keilton+autani app

FLEXIBLE AND COMFORTABLE WORK SPACE

Keilton+autani controls create office spaces where occupant comfort and energy savings go hand in hand. With Luminaire Level Lighting Control, each fixture is individually addressable, allowing for the most flexibility and the most savings. Lighting levels can be dynamically adjusted based on occupancy and daylight harvesting to maximize savings while maintaining appropriate light levels for occupants. Adding plug load control eliminates phantom power use, increasing energy savings. Energy use within the space can be monitored and controlled via phone or tablet using the Keilton+autani app, or elevate to a Tier 3 solution offering analytics capabilities with the Autani Manager.

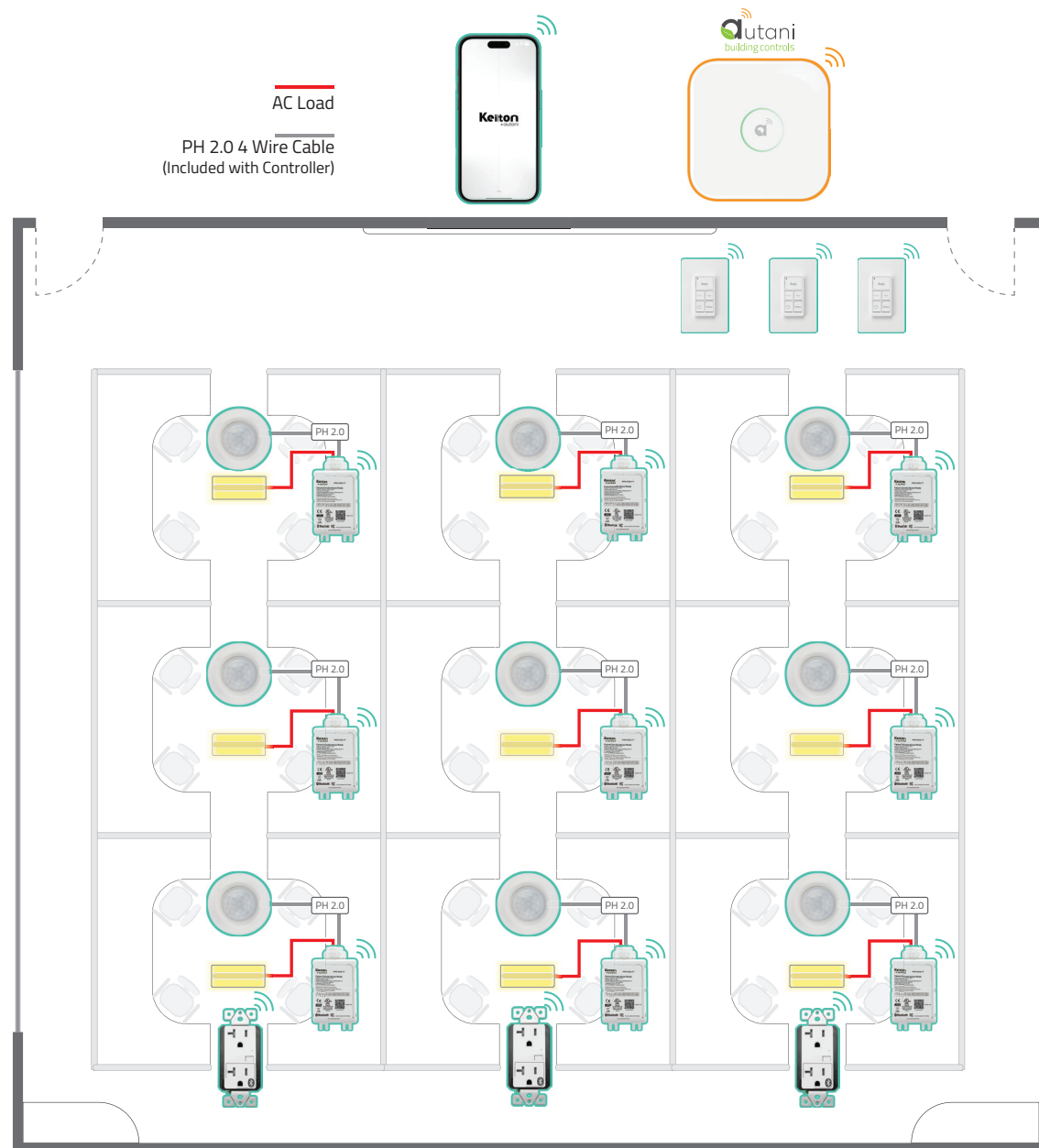

PRODUCT RECOMMENDATIONS



PPA102S.C1 Line Voltage 6A Bluetooth Fixture Controller

- 120-277VAC input
- Integrated 6A relay
- Offers 12V, 200mA output power to sensors
- Attaches with standard 1/2" knockout
- Provides 0-10VDC single channel output with RJ45 Eco Sensor Port



WP1013.A0 (3 Button) / WP1025.B1 (5 Button) Battery-Powered Bluetooth Wall Switch

- Quick push-button control of Keilton+autani devices via Bluetooth
- Powered by a single CR2032 battery
- Approximately 10 years battery life
- Can be wall-mounted or used as portable remote controller
- Can be linked to a light or light group via the Keilton+autani app



IFS105E.A0 Integrated Round 12V Low Bay Eco Sensor

- 12VDC input
- PIR Sensor (no Bluetooth)
- Daylight Harvesting
- Requires power from PPA102S Series controller, FA102 Series Adaptor, or BT Driver
- Digital sensor technology for low bay applications



RC02 Recessed Mounting Adaptor

- Specifically designed for easy installation of the IFS105E.A0 sensor



WF20R.A0 20A Plug Load Bluetooth Controller

- 120VAC
- 20A plug load Bluetooth controller
- Controllable via the Keilton+autani app

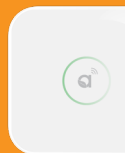

Autani Manager

The Autani Manager is the control processor at the heart of the innovative integrated energy management systems powered by EnergyCenter software. The Manager securely coordinates all energy management functions and provides actionable insights.

CR05.A0 + RTR.A0

- CR05 and RTR devices work in conjunction with the Manager to bring Bluetooth lighting controls into your network.
- Bluetooth network per CR05 may not exceed a radius of 100ft
- Bluetooth network per CR05 may not exceed 4 hops wireless mesh

CONTROL STRATEGIES



Occupancy / Vacancy Sensing

Turn lights on when occupants are in a space and off when they vacate the space. Alternate Functionality: Partial-on and manual-on modes are supported for additional savings and for more stringent local codes.



High-End Trim | Institutional Tuning

Set the maximum light level based on customer requirements in each space to prevent overlighting.



Daylight Harvesting

Dim lighting when daylight is available. Multiple zones are supported where required by code.



Automatic Scheduling & Timeclock*

Automatically dim or shut off lighting based on centrally managed schedules.

* Requires Autani Manager or CR02-W.A0.



Demand Response*

Manage lighting and electrical loads per utility requirements during periods of high demand.

* Requires Autani Manager.



ESTIMATED TOTAL SAVINGS: 20-50%

Alternative Product Recommendations



WP1018A.A0 8-Key Battery-Powered Bluetooth Wall Switch

- Quick push-button control of Keilton+autani devices via Bluetooth
- Powered by two AAA batteries
- Approximately 10 years battery life
- Can be wall-mounted or used as portable remote controller
- Can be linked to a light or light group via the Keilton+autani app

Small Office / Storage / Utility – Occupancy Switch

FAST AND ECONOMICAL LOAD CONTROL

Quickly outfit small spaces for lighting and plug load control by using a wall switch with an integrated occupancy sensor.

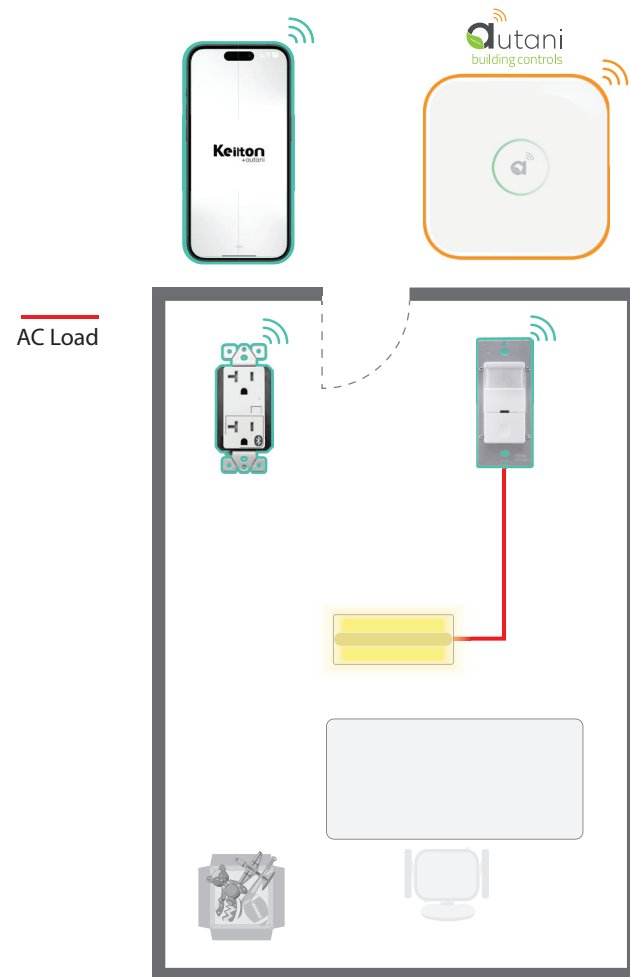

PRODUCT RECOMMENDATIONS

TIER - 02



IWS102.A0 Line Voltage Occ/Vacancy Sensor Bluetooth Wall Switch

- ↪ 120-277VAC
- ↪ Ideal retrofit of existing wall controls (neutral is required)
- ↪ Occupancy and vacancy control of Keilton+autani devices via Bluetooth
- ↪ Integrated relay, PIR sensor, and photo sensor with Hold-Off functionality

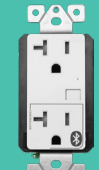

WF20R.A0 20A Plug Load Bluetooth Controller

- ↪ 120VAC
- ↪ 20A plug load Bluetooth controller
- ↪ Controllable via the Keilton+autani app

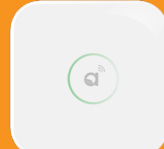

Autani Manager

The Autani Manager is the control processor at the heart of the innovative integrated energy management systems powered by EnergyCenter software. The Manager securely coordinates all energy management functions and provides actionable insights.

CR05.A0 + RTR.A0

- ↪ CR05 and RTR devices work in conjunction with the Manager to bring Bluetooth lighting controls into your network.
- ↪ Bluetooth network per CR05 may not exceed a radius of 100ft
- ↪ Bluetooth network per CR05 may not exceed 4 hops wireless mesh

CONTROL STRATEGIES

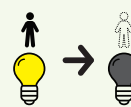

Occupancy / Vacancy Sensing

Turn lights on when occupants are in a space and off when they vacate the space. Alternate Functionality: Partial-on and manual-on modes are supported for additional savings and for more stringent local codes.



Automatic Scheduling & Timeclock*

Automatically dim or shut off lighting based on centrally managed schedules.

* Requires Autani Manager or CR02-W.A0.

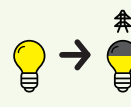

Demand Response*

Manage lighting and electrical loads per utility requirements during periods of high demand.

* Requires Autani Manager.



ESTIMATED TOTAL SAVINGS: 20-50%

Alternative Product Recommendations



CS107D.B1 Line Voltage Dual-Tech Ceiling Sensor

- ↪ 120-277VAC input
- ↪ 600 sq ft room coverage
- ↪ Daylight Harvesting
- ↪ Dual-tech PIR + Ultrasonic technology provides high accuracy and wide coverage
- ↪ Wireless Bluetooth connection to other Keilton+autani devices



WP1013.A0 (3 Button) / WP1025.B1 (5 Button) Battery-Powered Bluetooth Wall Switch

- ↪ Quick push-button control of Keilton+autani devices via Bluetooth
- ↪ Powered by a single CR2032 battery
- ↪ Approximately 10 years battery life
- ↪ Can be wall-mounted or used as portable remote controller
- ↪ Can be linked to a light or light group via the Keilton+autani app

Office - Zone Control

FAST AND ECONOMICAL LOAD CONTROL

Using zone-based controls within a small office space allows a single occupancy sensor to drive multiple fixtures. Adding a plug load controller supports Title 24 usage scenarios and enables energy draining components such as monitors and printers to be powered down during off hours.

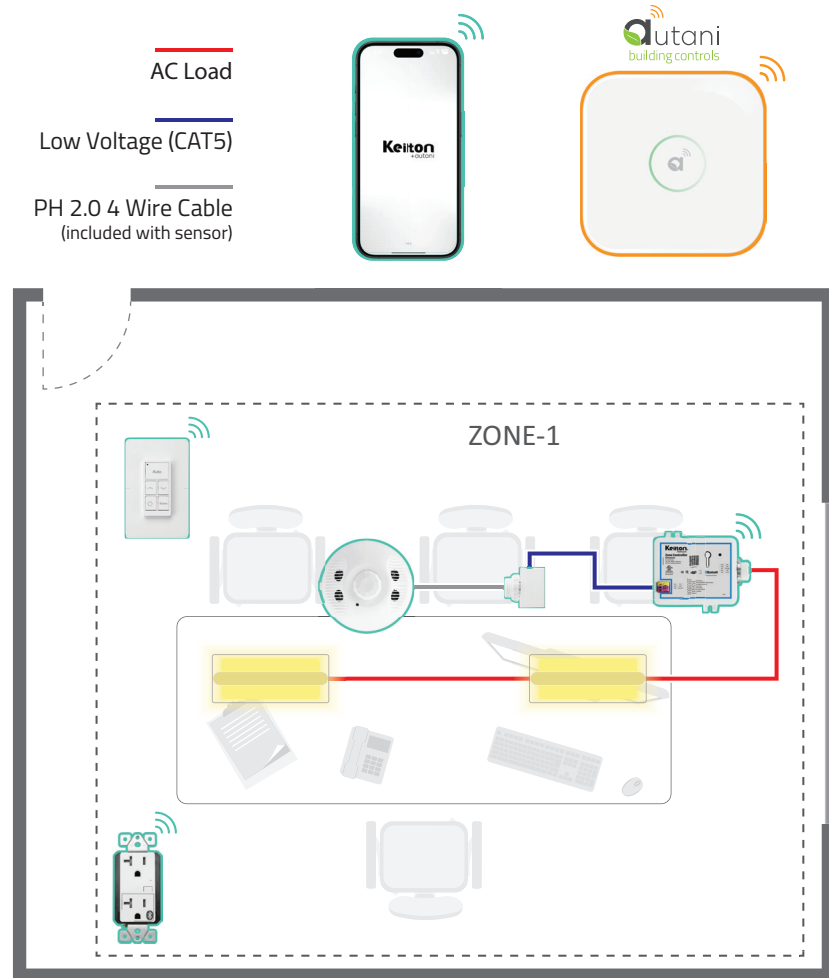

PRODUCT RECOMMENDATIONS



PPA104S.B1 Line Voltage 20A Bluetooth Zone Control

- 120-277VAC input
- Integrated 20A relay
- Output power up to 2400W (120VAC), 5540W (277VAC)
- UL Plenum Rated
- 1 HP motor load rated



WP1013.A0 (3 Button) / WP1025.B1 (5 Button) Battery-Powered Bluetooth Wall Switch

- Quick push-button control of Keilton+autani devices via Bluetooth
- Powered by a single CR2032 battery
- Approximately 10 years battery life
- Can be wall-mounted or used as portable remote controller
- Can be linked to a light or light group via the Keilton+autani app



EFS107E.A0 12V Dual-Tech Ceiling Eco Sensor

- 12VDC input
- Powered by power packs (PPA102Sx/PPA104Sx) and connected with low voltage cable
- 600 sq ft room coverage
- Daylight Harvesting
- Dual-tech PIR + Ultrasonic technology provides high accuracy and wide coverage



RTP - Tee Adaptor

- Connects from RJ45 to PH2.0
- Supports daisy chaining of multiple sensors

NOTE: Only the first device in a daisy chain can be used for daylight harvesting



WF20R.A0 20A Plug Load Bluetooth Controller

- 120VAC
- 20A plug load Bluetooth controller
- Controllable via the Keilton+autani app

TIER - 02

TIER - 03

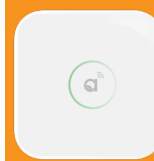

Autani Manager

The Autani Manager is the control processor at the heart of the innovative integrated energy management systems powered by EnergyCenter software. The Manager securely coordinates all energy management functions and provides actionable insights.

CRO5.A0 + RTR.A0

- CRO5 and RTR devices work in conjunction with the Manager to bring Bluetooth lighting controls into your network.
- Bluetooth network per CRO5 may not exceed a radius of 100ft
- Bluetooth network per CRO5 may not exceed 4 hops wireless mesh

CONTROL STRATEGIES



Occupancy / Vacancy Sensing

Turn lights on when occupants are in a space and off when they vacate the space. Alternate Functionality: Partial-on and manual-on modes are supported for additional savings and for more stringent local codes.



High-End Trim | Institutional Tuning

Set the maximum light level based on customer requirements in each space to prevent overlighting.



Daylight Harvesting

Dim lighting when daylight is available. Multiple zones are supported where required by code.



Automatic Scheduling & Timeclock*

Automatically dim or shut off lighting based on centrally managed schedules.

* Requires Autani Manager or CR02-W.A0.



Demand Response*

Manage lighting and electrical loads per utility requirements during periods of high demand.

* Requires Autani Manager.



ESTIMATED TOTAL SAVINGS: 20-50%

Alternative Product Recommendations



BCS107.B1 Battery-Powered Occupancy Sensor

- PIR + Daylight Harvesting
- 600 sq ft room coverage
- Occupancy / vacancy enabled
- Powered by a single CR123A 3V battery
- 10 years of estimated battery life
- Easy installation with multiple mounting options



WP1018A.A0 8-Key Battery-Powered Bluetooth Wall Switch

- Quick push-button control of Keilton+autani devices via Bluetooth
- Powered by two AAA batteries
- Approximately 10 years battery life
- Can be wall-mounted or used as portable remote controller
- Can be linked to a light or light group via the Keilton+autani app

Office - Luminaire Level Lighting Control (LLLC)

FLEXIBLE AND COMFORTABLE WORK SPACE

Luminaire Level Lighting Controls (LLLCs) can save on labor because the components can be installed on fixtures prior to installation in the ceiling. Lights can be virtually grouped to dim and switch on / off together. With LLLCs, each fixture is also individually addressable, allowing for the most flexibility and the most savings.

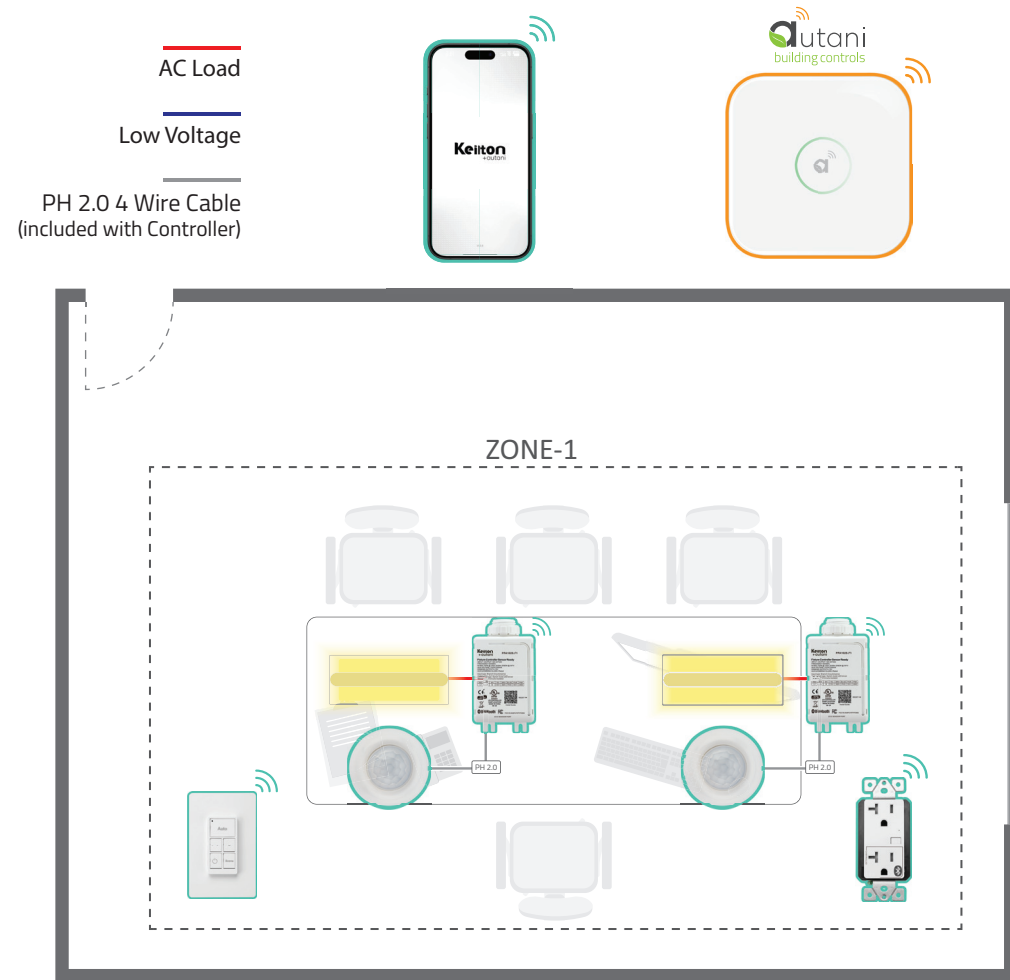

PRODUCT RECOMMENDATIONS

PPA102S.C1 Line Voltage 6A Bluetooth Fixture Controller

- 120-277VAC input
- Integrated 6A relay
- Offers 12V, 200mA output power to sensors
- Attaches with standard 1/2" knockout
- Provides 0-10VDC single channel output with RJ45 Eco Sensor Port

WP1013.A0 (3 Button) / WP1025.B1 (5 Button) Battery-Powered Bluetooth Wall Switch

- Quick push-button control of Keilton+autani devices via Bluetooth
- Powered by a single CR2032 battery
- Approximately 10 years battery life
- Can be wall-mounted or used as portable remote controller
- Can be linked to a light or light group via the Keilton+autani app

IFS105E.A0 Integrated Round 12V Low Bay Eco Sensor

- 12VDC input
- PIR Sensor (no Bluetooth)
- Daylight Harvesting
- Requires power from PPA102S Series controller, FA102 Series Adaptor, or BT Driver
- Digital sensor technology for low bay applications

RC02 Recessed Mounting Adaptor

- Specifically designed for easy installation of the IFS105E.A0 sensor

WF20R.A0 20A Plug Load Bluetooth Controller

- 120VAC
- 20A plug load Bluetooth controller
- Controllable via the Keilton+autani app

Autani Manager

The Autani Manager is the control processor at the heart of the innovative integrated energy management systems powered by EnergyCenter software. The Manager securely coordinates all energy management functions and provides actionable insights.

CR05.A0 + RTR.A0

- CR05 and RTR devices work in conjunction with the Manager to bring Bluetooth lighting controls into your network.
- Bluetooth network per CR05 may not exceed a radius of 100ft
- Bluetooth network per CR05 may not exceed 4 hops wireless mesh

CONTROL STRATEGIES

Occupancy / Vacancy Sensing

Turn lights on when occupants are in a space and off when they vacate the space. Alternate Functionality: Partial-on and manual-on modes are supported for additional savings and for more stringent local codes.

High-End Trim | Institutional Tuning

Set the maximum light level based on customer requirements in each space to prevent overlighting.

Daylight Harvesting

Dim lighting when daylight is available. Multiple zones are supported where required by code.

Automatic Scheduling & Timeclock*

Automatically dim or shut off lighting based on centrally managed schedules.

* Requires Autani Manager or CR02-W.A0.

Demand Response*

Manage lighting and electrical loads per utility requirements during periods of high demand.

* Requires Autani Manager.

ESTIMATED TOTAL SAVINGS: 20-50%

Alternative Product Recommendations

IFS108-N.A0 Clip-Mount Panel Sensor

- Clip-mount allows sensor to attach to luminaire housing
- 12V sensor with oval shape is ideal form factor for panels
- Bluetooth PIR analog sensor with Algo² algorithm to maximize detection without false trigger
- Allows existing panel and downlight luminaires to upgrade to luminaire level lighting control (LLLC)
- Daylight Harvesting

BCS107.B1 Battery Powered Occupancy Sensor

- PIR + Daylight Harvesting
- 600 sq ft room coverage
- Occupancy / vacancy enabled
- Powered by a single CR123A 3V battery
- 10 years of estimated battery life
- Easy installation with multiple mounting options

WP1018A.A0 8-Key Battery-Powered Bluetooth Wall Switch

- Quick push-button control of Keilton+autani devices via Bluetooth
- Powered by two AAA batteries
- Approximately 10 years battery life
- Can be wall-mounted or used as portable remote controller
- Can be linked to a light or light group via the Keilton+autani app

Nearly 66% of the utility spend in a warehouse can be attributed to lighting. By adding highbay sensors, you can be sure that all areas of your warehouse or manufacturing facility are always lit to the most appropriate levels, balancing both safety and savings. Lights can be virtually grouped to dim and switch on / off together. Each fixture is also individually addressable, allowing for the most flexibility and the most savings. Whether you own or lease your warehouse space, managing your facilities with Autani can reduce energy and maintenance costs, creating a more comfortable and secure operating environment for your customers and your employees.

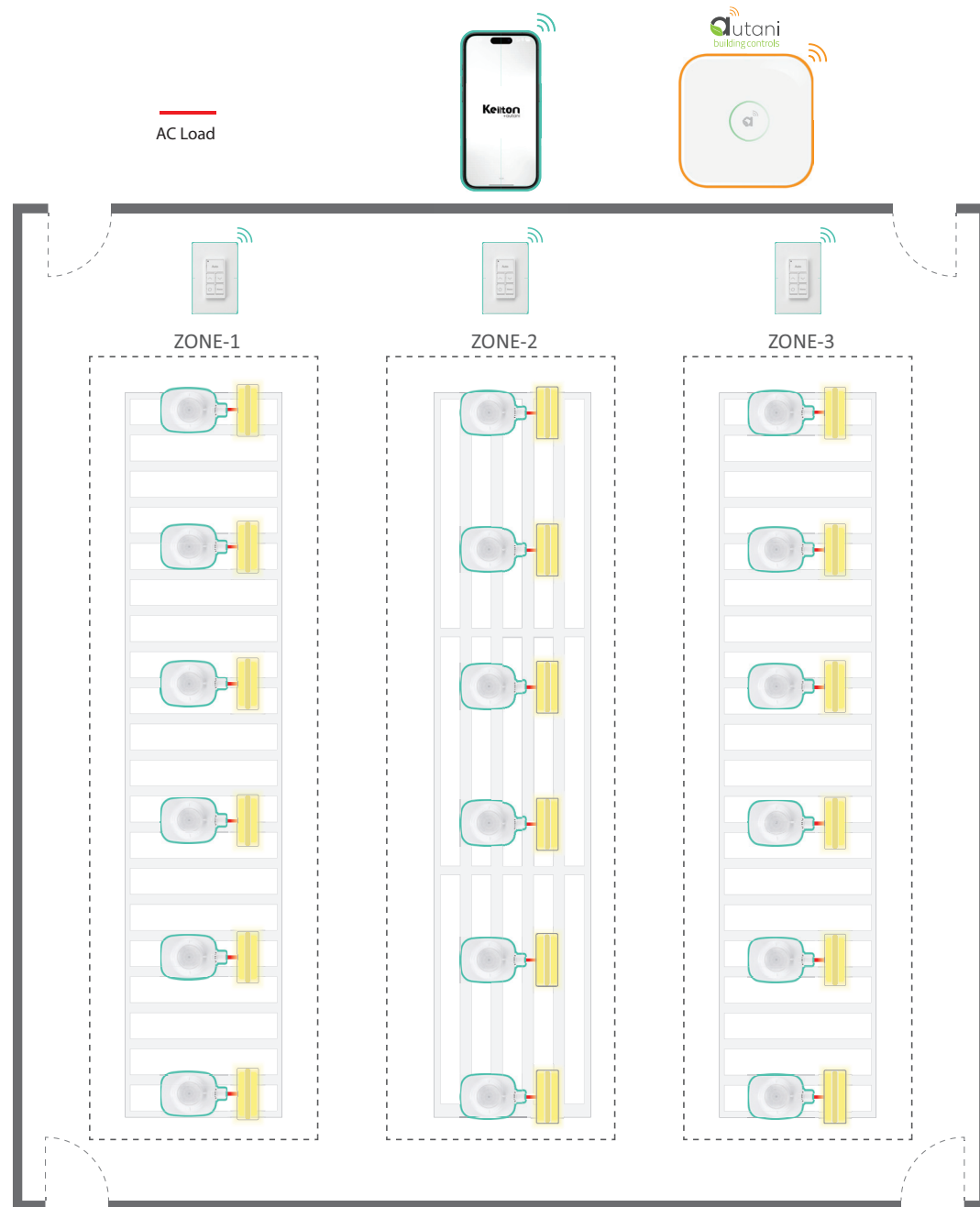

PRODUCT RECOMMENDATIONS

TIER - 02

TIER - 03

WP1013.A0 (3 Button) / WP1025.B1 (5 Button) Battery-Powered Bluetooth Wall Switch

- ↪ Quick push-button control of Keilton+autani devices via Bluetooth
- ↪ Powered by a single CR2032 battery
- ↪ Approximately 10 years battery life
- ↪ Can be wall-mounted or used as portable remote controller
- ↪ Can be linked to a light or light group via the Keilton+autani app

EFS104.B1 External Line Voltage High Bay Sensor

- ↪ 120-277VAC input
- ↪ Connects with 1/2" standard knockout
- ↪ Daylight Harvesting
- ↪ Bluetooth PIR analog sensor with Algo² algorithm to maximize detection without false trigger
- ↪ Replaceable lens options

NOTE: Lens sold separately

Autani Manager

The Autani Manager is the control processor at the heart of the innovative integrated energy management systems powered by EnergyCenter software. The Manager securely coordinates all energy management functions and provides actionable insights.

CR05.A0 + RTR.A0

- ↪ CR05 and RTR devices work in conjunction with the Manager to bring Bluetooth lighting controls into your network.
- ↪ Bluetooth network per CR05 may not exceed a radius of 100ft
- ↪ Bluetooth network per CR05 may not exceed 4 hops wireless mesh

CONTROL STRATEGIES

Occupancy / Vacancy Sensing

Turn lights on when occupants are in a space and off when they vacate the space. Alternate Functionality: Partial-on and manual-on modes are supported for additional savings and for more stringent local codes.

High-End Trim | Institutional Tuning

Set the maximum light level based on customer requirements in each space to prevent overlighting.

Daylight Harvesting

Dim lighting when daylight is available. Multiple zones are supported where required by code.

Automatic Scheduling & Timeclock*

Automatically dim or shut off lighting based on centrally managed schedules.

*** Requires Autani Manager or CR02-W.A0.**

Demand Response*

Manage lighting and electrical loads per utility requirements during periods of high demand.

*** Requires Autani Manager.**

ESTIMATED TOTAL SAVINGS: 20-50%

Alternative Product Recommendations

EFS106-AUX.B1 Plug and Play High Bay Long-Range Sensor

- ↪ 3.5mm audio jack connector
- ↪ Enhanced long-range antenna with up to 328 ft Bluetooth transmission range
- ↪ Plug and Play 12V sensor with integrated connector
- ↪ Bluetooth PIR analog sensor with Algo² algorithm to maximize detection without false trigger
- ↪ Replaceable lens options

NOTE: Lens sold separately

HBL3-2-W High Bay Lens

- ↪ Designed for 20 to 50 ft mounting heights
- ↪ IP40
- ↪ Powerful high bay lens with 360 degree coverage
- ↪ Optimized for open area and aisleway coverage in high bay applications
- ↪ Multi-cell, multi-tier Fresnel lens with high density coverage patterns

WP1018A.A0 8-Key Battery-Powered Bluetooth Wall Switch

- ↪ Quick push-button control of Keilton+autani devices via Bluetooth
- ↪ Powered by two AAA batteries
- ↪ Approximately 10 years battery life
- ↪ Can be wall-mounted or used as portable remote controller
- ↪ Can be linked to a light or light group via the Keilton+autani app

Wireless outdoor lighting management ensures that your grounds are properly illuminated in the right place, at the right time. Autani can help you find the balance between energy savings, outdoor safety, and the appropriate light levels needed to maximize the appeal of your facilities. Dimming control at each fixture allows the business manager to adjust the spatial distribution of lighting as well as change the dimming level to lower levels during non-business hours.

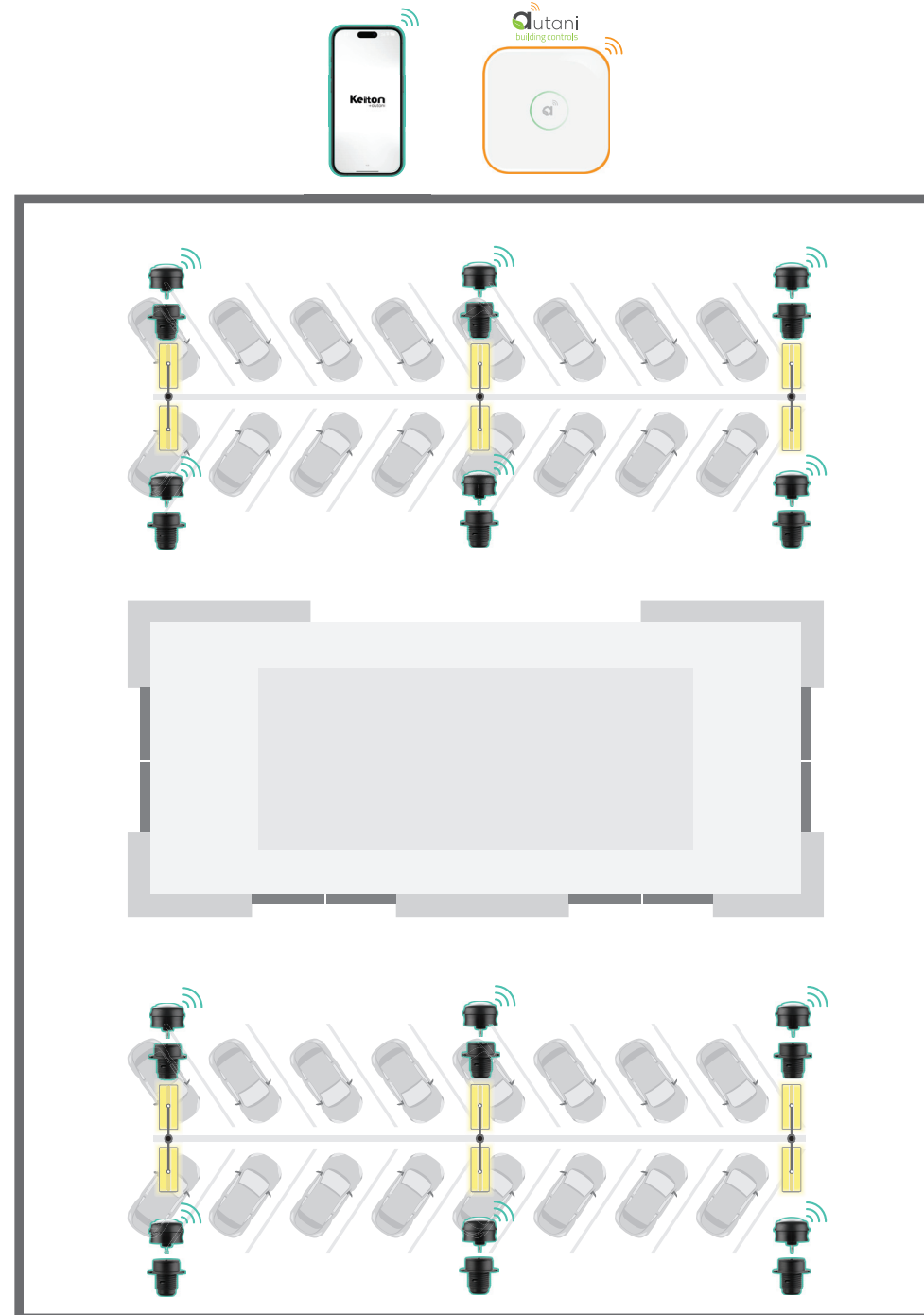

PRODUCT RECOMMENDATIONS

TIER - 02



EFS106-AUX-W.B2 Plug and Play High Bay Long-Range Sensor

- ↪ 3.5mm audio jack connector
 - ↪ Enhanced long-range antenna with up to 328 ft Bluetooth transmission range
 - ↪ Plug and Play 12V sensor with integrated connector
 - ↪ Bluetooth PIR analog sensor with Algo² algorithm to maximize detection without false trigger
 - ↪ Replaceable lens options
- NOTE:** Lens sold separately



WHBL1-2-B Wet Location High Bay Lens

- ↪ Designed for 20 to 40 ft mounting heights
- ↪ IP66
- ↪ Powerful high bay lens with 360 degree coverage
- ↪ Optimized for open area and aisleway coverage in high bay applications
- ↪ Multi-cell, multi-tier Fresnel lens with high density coverage patterns

WSC01

- ↪ Outdoor rated
- ↪ 3.5mm audio jack receptacle
- ↪ Allows additional fixture types to be used in plug and play luminaire level lighting control (LLLC)
- ↪ Low-profile design with minimal depth into housing and minimal height above luminaire
- ↪ Waterproof version offers UV-resistant high-impact rated covers to fully seal and protect the receptacles

TIER - 03

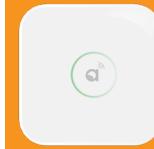

Autani Manager

The Autani Manager is the control processor at the heart of the innovative integrated energy management systems powered by EnergyCenter software. The Manager securely coordinates all energy management functions and provides actionable insights.

CR05.A0 + RTR.A0

- ↪ CR05 and RTR devices work in conjunction with the Manager to bring Bluetooth lighting controls into your network.
- ↪ Bluetooth network per CR05 may not exceed a radius of 100ft
- ↪ Bluetooth network per CR05 may not exceed 4 hops wireless mesh

CONTROL STRATEGIES



Occupancy / Vacancy Sensing

Turn lights on when occupants are in a space and off when they vacate the space. Alternate Functionality: Partial-on and manual-on modes are supported for additional savings and for more stringent local codes.



High-End Trim | Institutional Tuning

Set the maximum light level based on customer requirements in each space to prevent overlighting.



Automatic Scheduling & Timeclock*

Automatically dim or shut off lighting based on centrally managed schedules.

*** Requires Autani Manager or CR02-W.A0.**



Demand Response*

Manage lighting and electrical loads per utility requirements during periods of high demand.

*** Requires Autani Manager.**



ESTIMATED TOTAL SAVINGS: 20-50%

Dual-tech occupancy sensors use both passive infrared (PIR) and ultrasonic (US) technologies together to detect motion, even if the sensor does not have a direct view of a person within a restroom stall. Customizable timeouts ensure that appropriate lighting levels are maintained at all times.

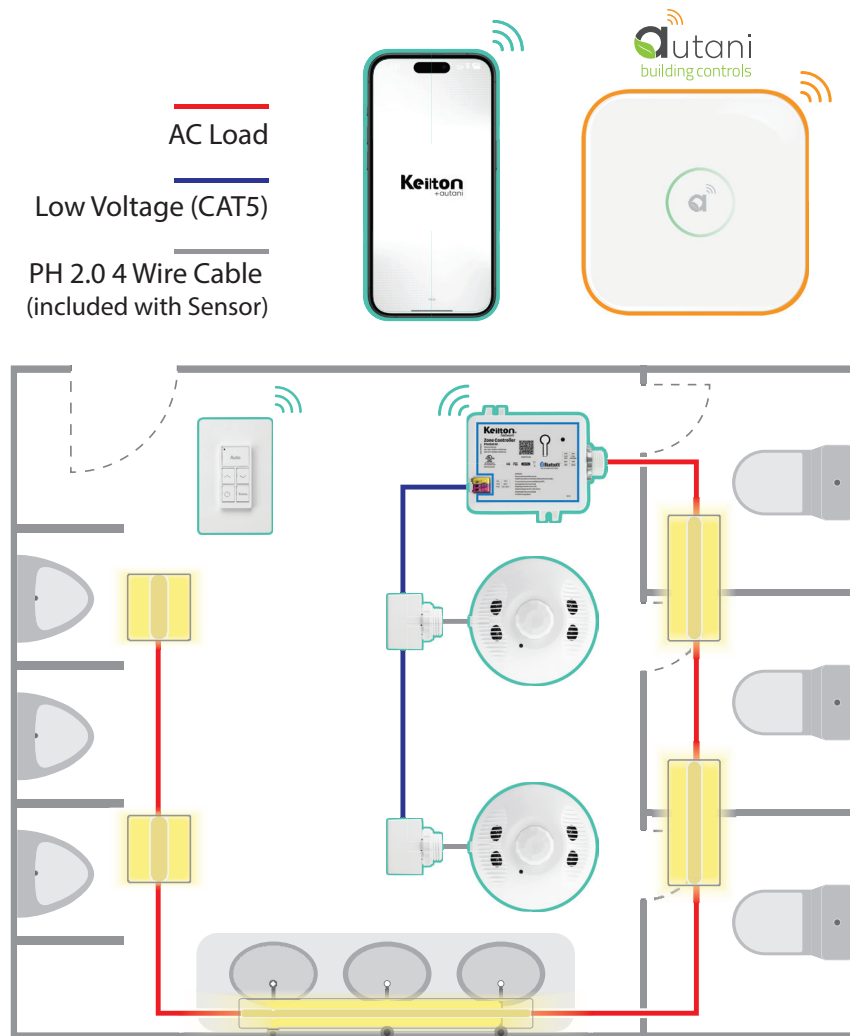

PRODUCT RECOMMENDATIONS

PPA104S.B1 Line Voltage 20A Bluetooth Zone Control

- 120-277VAC input
- Integrated 20A relay
- Output power up to 2400W (120VAC), 5540W (277VAC)
- UL Plenum Rated
- 1 HP motor load rated

WP1013.A0 (3 Button) / WP1025.B1 (5 Button) Battery-Powered Bluetooth Wall Switch

- Quick push-button control of Keiton+autani devices via Bluetooth
- Powered by a single CR2032 battery
- Approximately 10 years battery life
- Can be wall-mounted or used as portable remote controller
- Can be linked to a light or light group via the Keiton+autani app

RTP - Tee Adaptor

- Connects from RJ45 to PH2.0
- Supports daisy chaining of multiple sensors

NOTE: Only 1st device in daisy chain can be used for daylight harvesting.

EFS107E.A0 12V Dual-Tech Ceiling Eco Sensor

- 12VDC input
- Powered by power packs (PPA102Sx/PPA104Sx) and connected with low voltage cable
- 600 sq ft room coverage
- Daylight Harvesting
- Dual-tech PIR + Ultrasonic technology provides high accuracy and wide coverage

Autani Manager

The Autani Manager is the control processor at the heart of the innovative integrated energy management systems powered by EnergyCenter software. The Manager securely coordinates all energy management functions and provides actionable insights.

CR05.A0 + RTR.A0

- CR05 and RTR devices work in conjunction with the Manager to bring Bluetooth lighting controls into your network.
- Bluetooth network per CR05 may not exceed a radius of 100ft
- Bluetooth network per CR05 may not exceed 4 hops wireless mesh

CONTROL STRATEGIES

Occupancy / Vacancy Sensing

Turn lights on when occupants are in a space and off when they vacate the space. Alternate Functionality: Partial-on and manual-on modes are supported for additional savings and for more stringent local codes.

High-End Trim | Institutional Tuning

Set the maximum light level based on customer requirements in each space to prevent overlighting.

Daylight Harvesting

Dim lighting when daylight is available. Multiple zones are supported where required by code.

Automatic Scheduling & Timeclock*

Automatically dim or shut off lighting based on centrally managed schedules.

* Requires Autani Manager or CR02-W.A0.

Demand Response*

Manage lighting and electrical loads per utility requirements during periods of high demand.

* Requires Autani Manager.

ESTIMATED TOTAL SAVINGS: 20-50%

Alternative Product Recommendations

BCS107.B1 Battery Powered Ceiling Sensor

- PIR + Daylight Harvesting
- 600 sq ft room coverage
- Occupancy / vacancy enabled
- Powered by a single CR123A 3V battery
- 10 years of estimated battery life
- Easy installation with multiple mounting options

IWS102.A0 Line Voltage Occ/Vacancy Sensor Bluetooth Wall Switch

- 120-277VAC
- Ideal retrofit of existing wall controls (neutral is required)
- Occupancy and vacancy control of Keiton+autani devices via Bluetooth
- Integrated relay, PIR sensor, and photo sensor with Hold-Off functionality

WP1018A.A0 8-Key Battery-Powered Bluetooth Wall Switch

- Quick push-button control of Keiton+autani devices via Bluetooth
- Powered by two AAA batteries
- Approximately 10 years battery life
- Can be wall-mounted or used as portable remote controller
- Can be linked to a light or light group via the Keiton+autani app

Emergency - Hallway

SAFETY FOCUSED PASSAGEWAYS

Emergency lighting controllers allow specific lights to remain on during a power outage. When power falls back to a generator or alternative source, the emergency lighting controller automatically turns on emergency lighting fixtures. As a wireless solution, it delivers a lower installation cost while maintaining exceptional reliability.

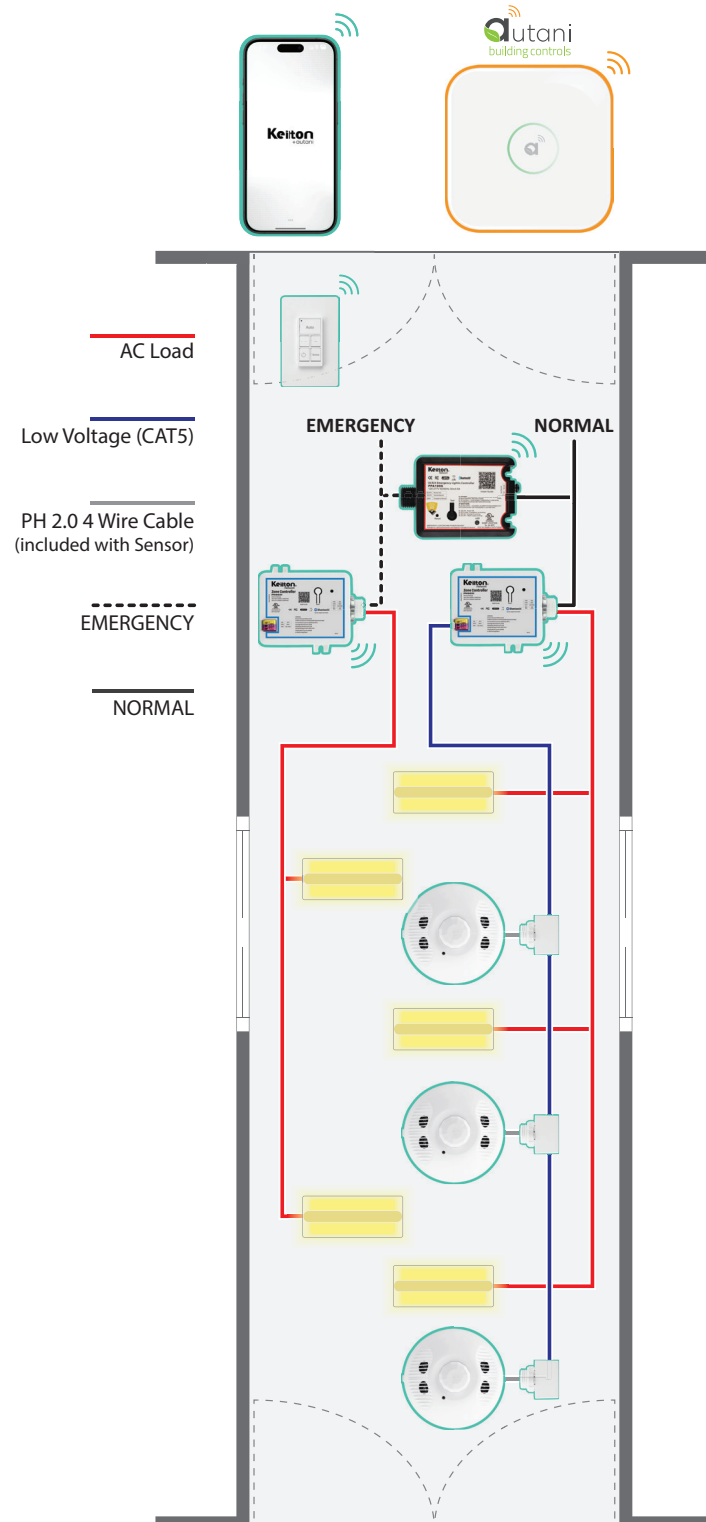

PRODUCT RECOMMENDATIONS

PPA109S.B1 UL924 Emergency Lighting Controller

- 120-277VAC input
- Auto detection of normal vs emergency power supply status
- Upon emergency power, sends wireless signal to Keilton+autani devices to turn on emergency lighting
- Integrated test button and easy wiring to remote test button or fire alarm interface
- Dual color function LED indicator for power supply status
- Meets UL924 requirements
- 1 device required per zone
- UL Plenum Rated

TIER - 02

PPA104S.B1 Line Voltage 20A Bluetooth Zone Control

- 120-277VAC input
- Integrated 20A relay
- Output power up to 2400W (120VAC), 5540W (277VAC)
- UL Plenum Rated
- 1 HP motor load rated

RTP - Tee Adaptor

- Connects from RJ45 to PH2.0
- Supports daisy chaining of multiple sensors
- NOTE:** Only 1st device in daisy chain can be used for daylight harvesting.

EFS107E.A0 12V Dual-Tech Ceiling Eco Sensor

- 12VDC input
- Powered by power packs (PPA102Sx/PPA104Sx) and connected with low voltage cable
- 600 sq ft room coverage
- Daylight Harvesting
- Dual-tech PIR + Ultrasonic technology provides high accuracy and wide coverage

WP1013.A0 (3 Button) / WP1025.B1 (5 Button) Battery-Powered Bluetooth Wall Switch

- Quick push-button control of Keilton+autani devices via Bluetooth
- Powered by a single CR2032 battery
- Approximately 10 years battery life
- Can be wall-mounted or used as portable remote controller
- Can be linked to a light or light group via the Keilton+autani app

Autani Manager

The Autani Manager is the control processor at the heart of the innovative integrated energy management systems powered by EnergyCenter software. The Manager securely coordinates all energy management functions and provides actionable insights.

CRO5.A0 + RTR.A0

- CRO5 and RTR devices work in conjunction with the Manager to bring Bluetooth lighting controls into your network.
- Bluetooth network per CRO5 may not exceed a radius of 100ft
- Bluetooth network per CRO5 may not exceed 4 hops wireless mesh

TIER - 03

CONTROL STRATEGIES

Occupancy / Vacancy Sensing
Turn lights on when occupants are in a space and off when they vacate the space. Alternate Functionality: Partial-on and manual-on modes are supported for additional savings and for more stringent local codes.

High-End Trim | Institutional Tuning
Set the maximum light level based on customer requirements in each space to prevent overlighting.

Daylight Harvesting
Dim lighting when daylight is available. Multiple zones are supported where required by code.

Automatic Scheduling & Timeclock*
Automatically dim or shut off lighting based on centrally managed schedules.
*** Requires Autani Manager or CR02-W.A0.**

Demand Response*
Manage lighting and electrical loads per utility requirements during periods of high demand.
*** Requires Autani Manager.**

ESTIMATED TOTAL SAVINGS: 20-50%

Alternative Product Recommendations

WP1018A.A0 8-Key Battery-Powered Bluetooth Wall Switch

- Quick push-button control of Keilton+autani devices via Bluetooth
- Powered by two AAA batteries
- Approximately 10 years battery life
- Can be wall-mounted or used as portable remote controller
- Can be linked to a light or light group via the Keilton+autani app

Conference Room - Zone Control

FLEXIBLE AND COMFORTABLE WORK SPACE

Keilton+autani provides a number of solutions that specifically address conference room and shared meeting spaces. The PPA104S.B1 Zone Controller provides a single zone of on/off and dimming capabilities. Lighting levels can be dynamically adjusted based on occupancy, daylight harvesting, or by using wireless wall switches. Energy use within the space can be monitored and controlled via phone or tablet using the Keilton+autani app, or elevate to a Tier 3 solution offering analytics capabilities with the Autani Manager.

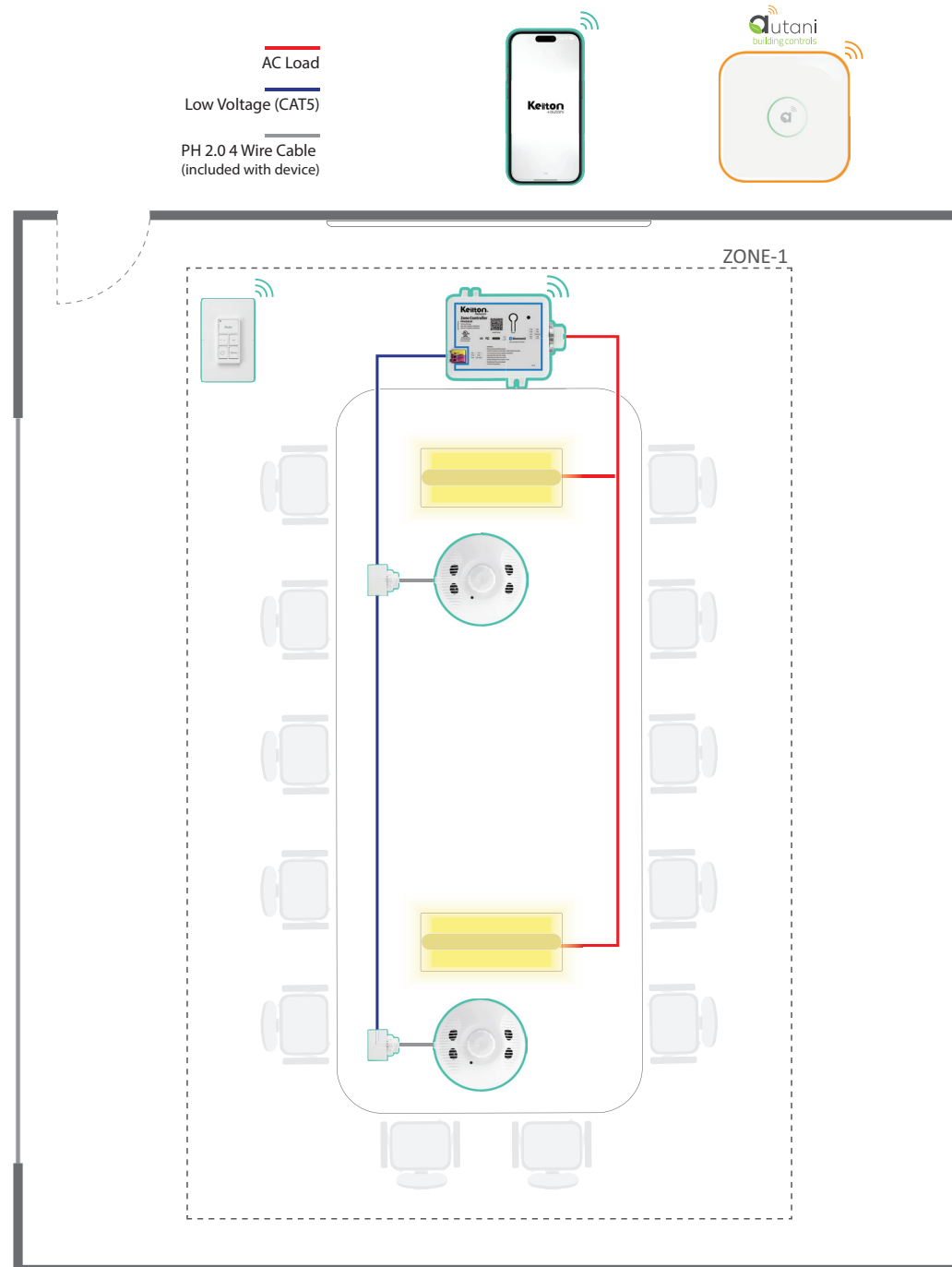

PRODUCT RECOMMENDATIONS

TIER - 02

TIER - 03

PPA104S.B1 Line Voltage 20A Bluetooth Zone Control

- 120-277VAC input
- Integrated 20A relay
- Output power up to 2400W (120VAC), 5540W (277VAC)
- UL Plenum Rated
- 1 HP motor load rated

EFS107E.A0 12V Dual-Tech Ceiling Eco Sensor

- 12VDC input
- Powered by power packs (PPA102Sx/PPA104Sx) and connected with low voltage cable
- 600 sq ft room coverage
- Daylight Harvesting
- Dual-tech PIR + Ultrasonic technology provides high accuracy and wide coverage

RTP - Tee Adaptor

- Connects from RJ45 to PH2.0
- Supports daisy chaining of multiple sensors

NOTE: Only 1st device in daisy chain can be used for daylight harvesting.

WP1013.A0 (3 Button) / WP1025.B1 (5 Button) Battery-Powered Bluetooth Wall Switch

- Quick push-button control of Keilton+autani devices via Bluetooth
- Powered by a single CR2032 battery
- Approximately 10 years battery life
- Can be wall-mounted or used as portable remote controller
- Can be linked to a light or light group via the Keilton+autani app

Autani Manager

The Autani Manager is the control processor at the heart of the innovative integrated energy management systems powered by EnergyCenter software. The Manager securely coordinates all energy management functions and provides actionable insights.

CRO5.A0 + RTR.A0

- CRO5 and RTR devices work in conjunction with the Manager to bring Bluetooth lighting controls into your network.
- Bluetooth network per CRO5 may not exceed a radius of 100ft
- Bluetooth network per CRO5 may not exceed 4 hops wireless mesh

CONTROL STRATEGIES

- Occupancy / Vacancy Sensing**
Turn lights on when occupants are in a space and off when they vacate the space. Alternate Functionality: Partial-on and manual-on modes are supported for additional savings and for more stringent local codes.
- High-End Trim | Institutional Tuning**
Set the maximum light level based on customer requirements in each space to prevent overlighting.
- Daylight Harvesting**
Dim lighting when daylight is available. Multiple zones are supported where required by code.
- Automatic Scheduling & Timeclock***
Automatically dim or shut off lighting based on centrally managed schedules.
*** Requires Autani Manager or CR02-W.A0.**
- Demand Response***
Manage lighting and electrical loads per utility requirements during periods of high demand.
*** Requires Autani Manager.**
- ESTIMATED TOTAL SAVINGS: 20-50%**

Alternative Product Recommendations

WP1018A.A0 8-Key Battery-Powered Bluetooth Wall Switch

- Quick push-button control of Keilton+autani devices via Bluetooth
- Powered by two AAA batteries
- Approximately 10 years battery life
- Can be wall-mounted or used as portable remote controller
- Can be linked to a light or light group via the Keilton+autani app

Conference Room - Luminaire Level Lighting Control (LLLC)

FLEXIBLE AND COMFORTABLE WORK SPACE

Luminaire Level Lighting Controls (LLLCs) can save on labor because the components can be installed on fixtures prior to installation in the ceiling. Lights can be virtually grouped to dim and switch on / off together. With LLLCs, each fixture is also individually addressable, allowing for the most flexibility and the most savings.

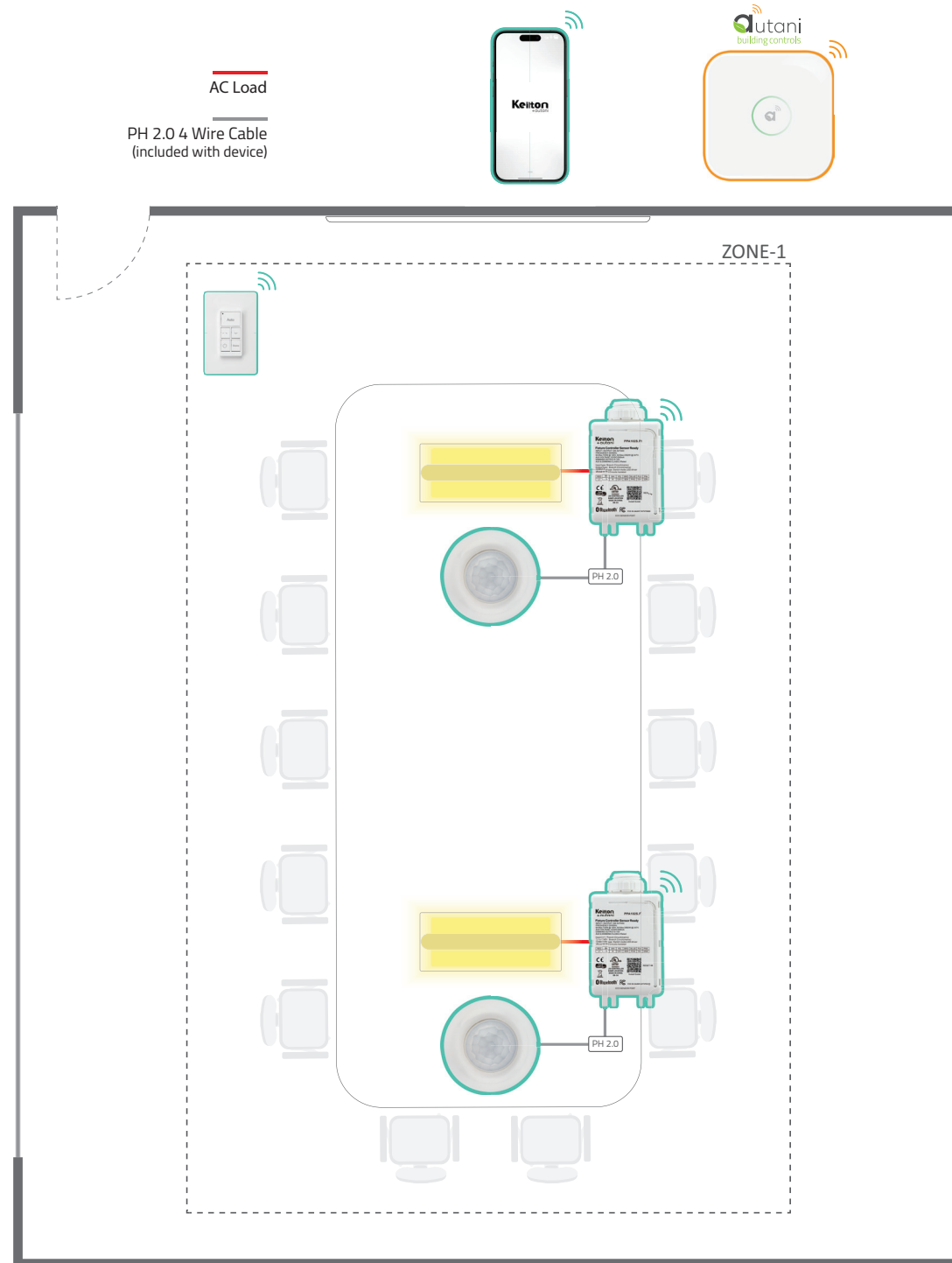

PRODUCT RECOMMENDATIONS

PPA102S.C1 Line Voltage 6A Bluetooth Fixture Controller

- 120-277VAC input
- Integrated 6A relay
- Offers 12V, 200mA output power to sensors
- Attaches with standard 1/2" knockout
- Provides 0-10VDC single channel output with RJ45 Eco Sensor Port

IFS105E.A0 Integrated Round 12V Low Bay Eco Sensor

- 12VDC input
- PIR Sensor (no Bluetooth)
- Daylight Harvesting
- Requires power from PPA102S Series controller, FA102 Series Adaptor, or Bluetooth Driver
- Digital sensor technology for low bay applications

RC02 Recessed Mounting Adaptor

- Specifically designed for easy installation of the IFS105E.A0 sensor

WP1013.A0 (3 Button) / WP1025.B1 (5 Button) Battery-Powered Bluetooth Wall Switch

- Quick push-button control of Keilton+autani devices via Bluetooth
- Powered by a single CR2032 battery
- Approximately 10 years battery life
- Can be wall-mounted or used as portable remote controller
- Can be linked to a light or light group via the Keilton+autani app

Autani Manager

The Autani Manager is the control processor at the heart of the innovative integrated energy management systems powered by EnergyCenter software. The Manager securely coordinates all energy management functions and provides actionable insights.

CR05.A0 + RTR.A0

- CR05 and RTR devices work in conjunction with the Manager to bring Bluetooth lighting controls into your network.
- Bluetooth network per CR05 may not exceed a radius of 100ft
- Bluetooth network per CR05 may not exceed 4 hops wireless mesh

CONTROL STRATEGIES

Occupancy / Vacancy Sensing
Turn lights on when occupants are in a space and off when they vacate the space. Alternate Functionality: Partial-on and manual-on modes are supported for additional savings and for more stringent local codes.

High-End Trim | Institutional Tuning
Set the maximum light level based on customer requirements in each space to prevent overlighting.

Daylight Harvesting
Dim lighting when daylight is available. Multiple zones are supported where required by code.

Automatic Scheduling & Timeclock*
Automatically dim or shut off lighting based on centrally managed schedules.
*** Requires Autani Manager or CR02-W.A0.**

Demand Response*
Manage lighting and electrical loads per utility requirements during periods of high demand.
*** Requires Autani Manager.**

ESTIMATED TOTAL SAVINGS: 20-50%

Alternative Product Recommendations

WP1018A.A0 8-Key Battery-Powered Bluetooth Wall Switch

- Quick push-button control of Keilton+autani devices via Bluetooth
- Powered by two AAA batteries
- Approximately 10 years battery life
- Can be wall-mounted or used as portable remote controller
- Can be linked to a light or light group via the Keilton+autani app

Classroom - Zone Control

FLEXIBLE AND COMFORTABLE LEARNING SPACE

Keilton+autani controls create classrooms where occupant comfort and energy savings go hand in hand. Lighting levels can be dynamically adjusted based on occupancy or by using wireless wall switches. Daylight harvesting allows lighting use to be dialed back when exterior daylight enters the space. By zoning lights within the space, savings from daylight harvesting is maximized while maintaining appropriate light levels for occupants. Adding plug load control eliminates phantom power use, increasing energy savings. Energy use within the space can be monitored and controlled via phone or tablet using the Keilton+autani app, or elevate to a Tier 3 solution offering analytics capabilities with the Autani Manager.

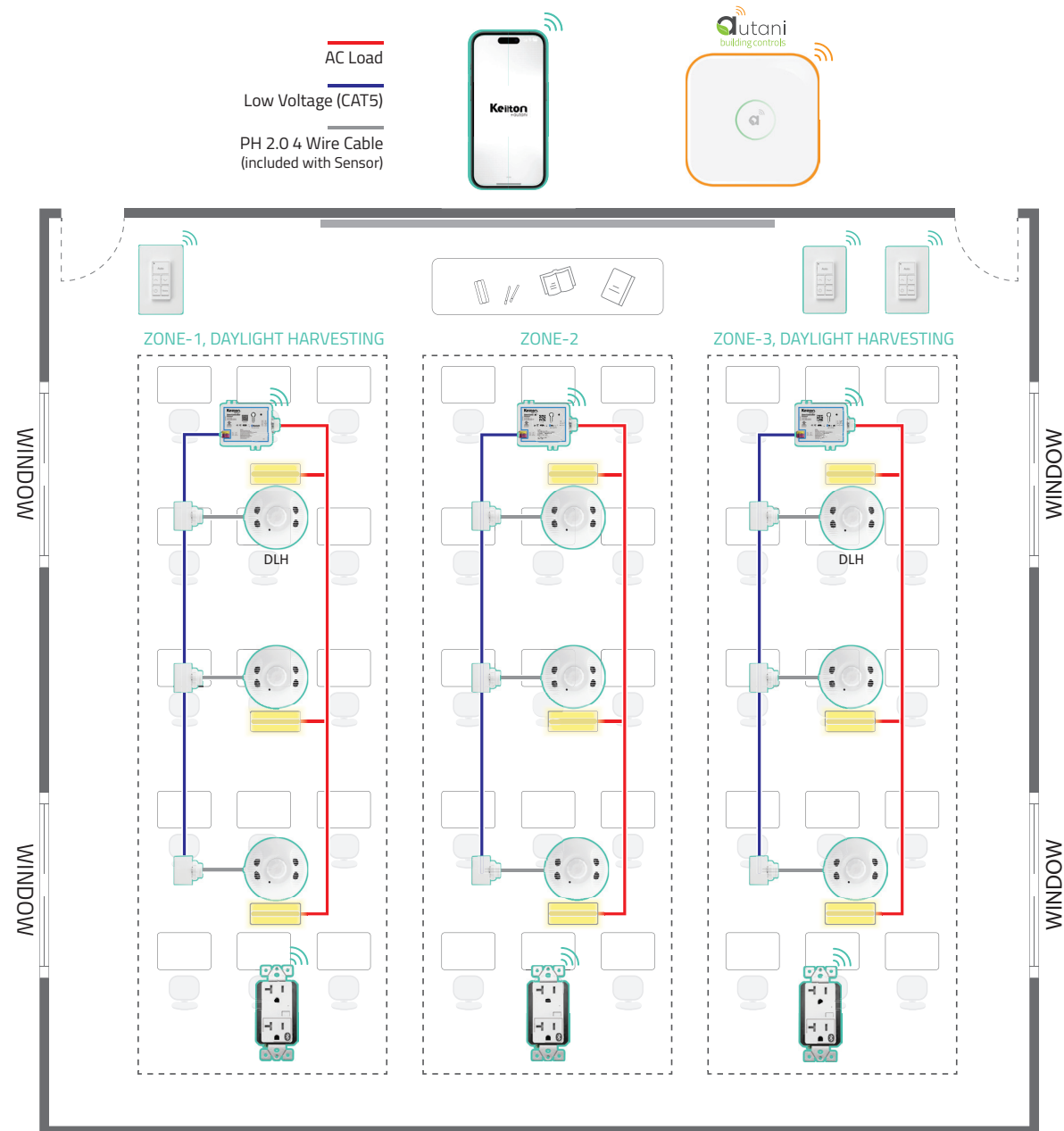

PRODUCT RECOMMENDATIONS

TIER - 02

TIER - 03

- PPA104S.B1 Line Voltage 20A Bluetooth Zone Control**
 - 120-277VAC input
 - Integrated 20A relay
 - Output power up to 2,400W (120VAC), 5,540W (277VAC)
 - UL Plenum Rated
 - 1 HP motor load rated
- WP1013.A0 (3 Button) / WP1025.B1 (5 Button) Battery-Powered Bluetooth Wall Switch**
 - Quick push-button control of Keilton+autani devices via Bluetooth
 - Powered by a single CR2032 battery
 - Approximately 10 years battery life
 - Can be wall-mounted or used as portable remote controller
 - Can be linked to a light or light group via the Keilton+autani app
- EFS107E.A0 12V Dual-Tech Ceiling Eco Sensor**
 - 12VDC input
 - Powered by power packs (PPA1025x/PPA1045x) and connected with low voltage cable
 - 600 sq ft room coverage
 - Daylight Harvesting
 - Dual-tech PIR + Ultrasonic technology provides high accuracy and wide coverage
- RTP - Tee Adaptor**
 - Connects from RJ45 to PH2.0
 - Supports daisy chaining of multiple sensors
 - NOTE:** Only the first device in a daisy chain can be used for daylight harvesting
- WF20R.A0 20A Plug Load Bluetooth Controller**
 - 120VAC
 - 20A plug load Bluetooth controller
 - Controllable via the Keilton+autani app
- Autani Manager**

The Autani Manager is the control processor at the heart of the innovative integrated energy management systems powered by EnergyCenter software. The Manager securely coordinates all energy management functions and provides actionable insights.
- CR05.A0 + RTR.A0**
 - CR05 and RTR devices work in conjunction with the Manager to bring Bluetooth lighting controls into your network.
 - Bluetooth network per CR05 may not exceed a radius of 100ft
 - Bluetooth network per CR05 may not exceed 4 hops wireless mesh

CONTROL STRATEGIES

- Occupancy / Vacancy Sensing**

Turn lights on when occupants are in a space and off when they vacate the space. Alternate Functionality: Partial-on and manual-on modes are supported for additional savings and for more stringent local codes.
- High-End Trim | Institutional Tuning**

Set the maximum light level based on customer requirements in each space to prevent overlighting.
- Daylight Harvesting**

Dim lighting when daylight is available. Multiple zones are supported where required by code.
- Automatic Scheduling & Timeclock***

Automatically dim or shut off lighting based on centrally managed schedules.
* Requires Autani Manager or CR02-W.A0.
- Demand Response***

Manage lighting and electrical loads per utility requirements during periods of high demand.
* Requires Autani Manager.
- ESTIMATED TOTAL SAVINGS: 20-50%**

Alternative Product Recommendations

- BCS107.B1 Battery-Powered Occupancy Sensor**
 - PIR + Daylight Harvesting
 - 600 sq ft room coverage
 - Occupancy / vacancy enabled
 - Powered by a single CR123A battery
 - 10 years of estimated battery life
 - Easy installation with multiple mounting options
- WP1018A.A0 8-Key Battery-Powered Bluetooth Wall Switch**
 - Quick push-button control of Keilton+autani devices via Bluetooth
 - Powered by two AAA batteries
 - Approximately 10 years battery life
 - Can be wall-mounted or used as portable remote controller
 - Can be linked to a light or light group via the Keilton+autani app

Classroom - Luminaire Level Lighting Control (LLLC)

FLEXIBLE AND COMFORTABLE LEARNING SPACE

Keilton+autani controls create classrooms where occupant comfort and energy savings go hand in hand. With Luminaire Level Lighting Control, each fixture is individually addressable, allowing for the most flexibility and the most savings. Lighting levels can be dynamically adjusted based on occupancy and daylight harvesting to maximize savings while maintaining appropriate light levels for occupants. Adding plug load control eliminates phantom power use, increasing energy savings. Energy use within the space can be monitored and controlled via phone or tablet using the Keilton+autani app, or elevate to a Tier 3 solution offering analytics capabilities with the Autani Manager.

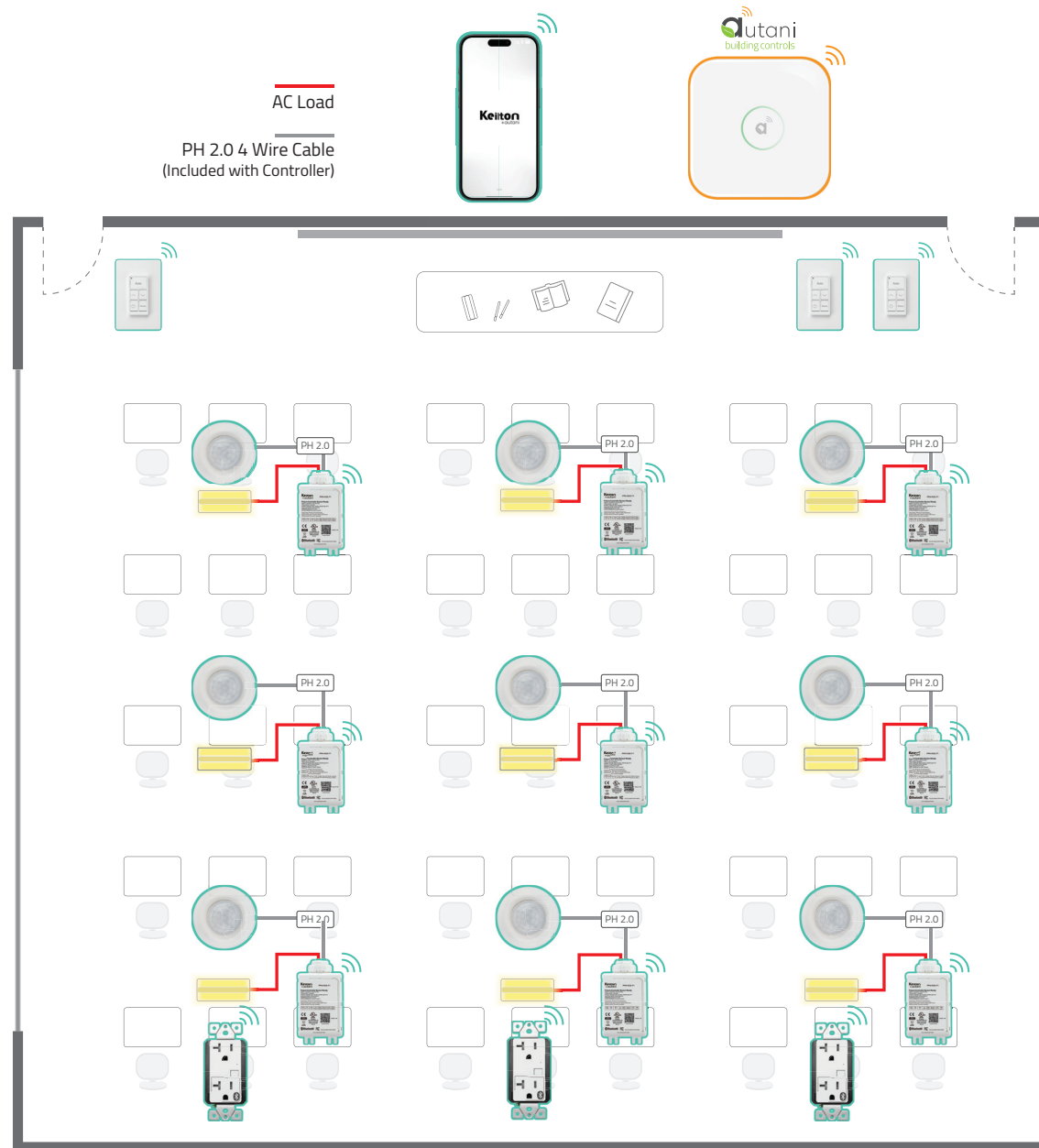

PRODUCT RECOMMENDATIONS



PPA102S.C1 Line Voltage 6A Bluetooth Fixture Controller

- 120-277VAC input
- Integrated 6A relay
- Offers 12V, 200mA output power to sensors
- Attaches with standard 1/2" knockout
- Provides 0-10VDC single channel output with RJ45 Eco Sensor Port



WP1013.A0 (3 Button) / WP1025.B1 (5 Button) Battery-Powered Bluetooth Wall Switch

- Quick push-button control of Keilton+autani devices via Bluetooth
- Powered by a single CR2032 battery
- Approximately 10 years battery life
- Can be wall-mounted or used as portable remote controller
- Can be linked to a light or light group via the Keilton+autani app

TIER - 02



IFS105E.A0 Integrated Round 12V Low Bay Eco Sensor

- 12VDC input
- PIR Sensor (no Bluetooth)
- Daylight Harvesting
- Requires power from PPA102S Series controller, FA102 Series Adaptor, or BT Driver
- Digital sensor technology for low bay applications



RC02 Recessed Mounting Adaptor

- Specifically designed for easy installation of the IFS105E.A0 sensor



WF20R.A0 20A Plug Load Bluetooth Controller

- 120VAC
- 20A plug load Bluetooth controller
- Controllable via the Keilton+autani app

TIER - 03

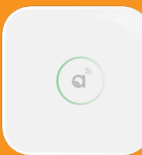

Autani Manager

The Autani Manager is the control processor at the heart of the innovative integrated energy management systems powered by EnergyCenter software. The Manager securely coordinates all energy management functions and provides actionable insights.

CR05.A0 + RTR.A0

- CR05 and RTR devices work in conjunction with the Manager to bring Bluetooth lighting controls into your network.
- Bluetooth network per CR05 may not exceed a radius of 100ft
- Bluetooth network per CR05 may not exceed 4 hops wireless mesh

CONTROL STRATEGIES



Occupancy / Vacancy Sensing

Turn lights on when occupants are in a space and off when they vacate the space. Alternate Functionality: Partial-on and manual-on modes are supported for additional savings and for more stringent local codes.



High-End Trim | Institutional Tuning

Set the maximum light level based on customer requirements in each space to prevent overlighting.



Daylight Harvesting

Dim lighting when daylight is available. Multiple zones are supported where required by code.



Automatic Scheduling & Timeclock*

Automatically dim or shut off lighting based on centrally managed schedules.

* Requires Autani Manager or CR02-W.A0.



Demand Response*

Manage lighting and electrical loads per utility requirements during periods of high demand.

* Requires Autani Manager.

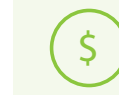

ESTIMATED TOTAL SAVINGS: 20-50%

Alternative Product Recommendations



WP1018A.A0 8-Key Battery-Powered Bluetooth Wall Switch

- Quick push-button control of Keilton+autani devices via Bluetooth
- Powered by two AAA batteries
- Approximately 10 years battery life
- Can be wall-mounted or used as portable remote controller
- Can be linked to a light or light group via the Keilton+autani app

FLEXIBLE AND COMFORTABLE WORK SPACE

Plug loads, such as task lighting, computer monitors, and printers, account for more than 5% of commercial electricity usage. Many energy codes now require control of receptacles for compliance. Based on schedule, the relay module switches the power to the receptacles on or off, reducing the amount of energy consumed.

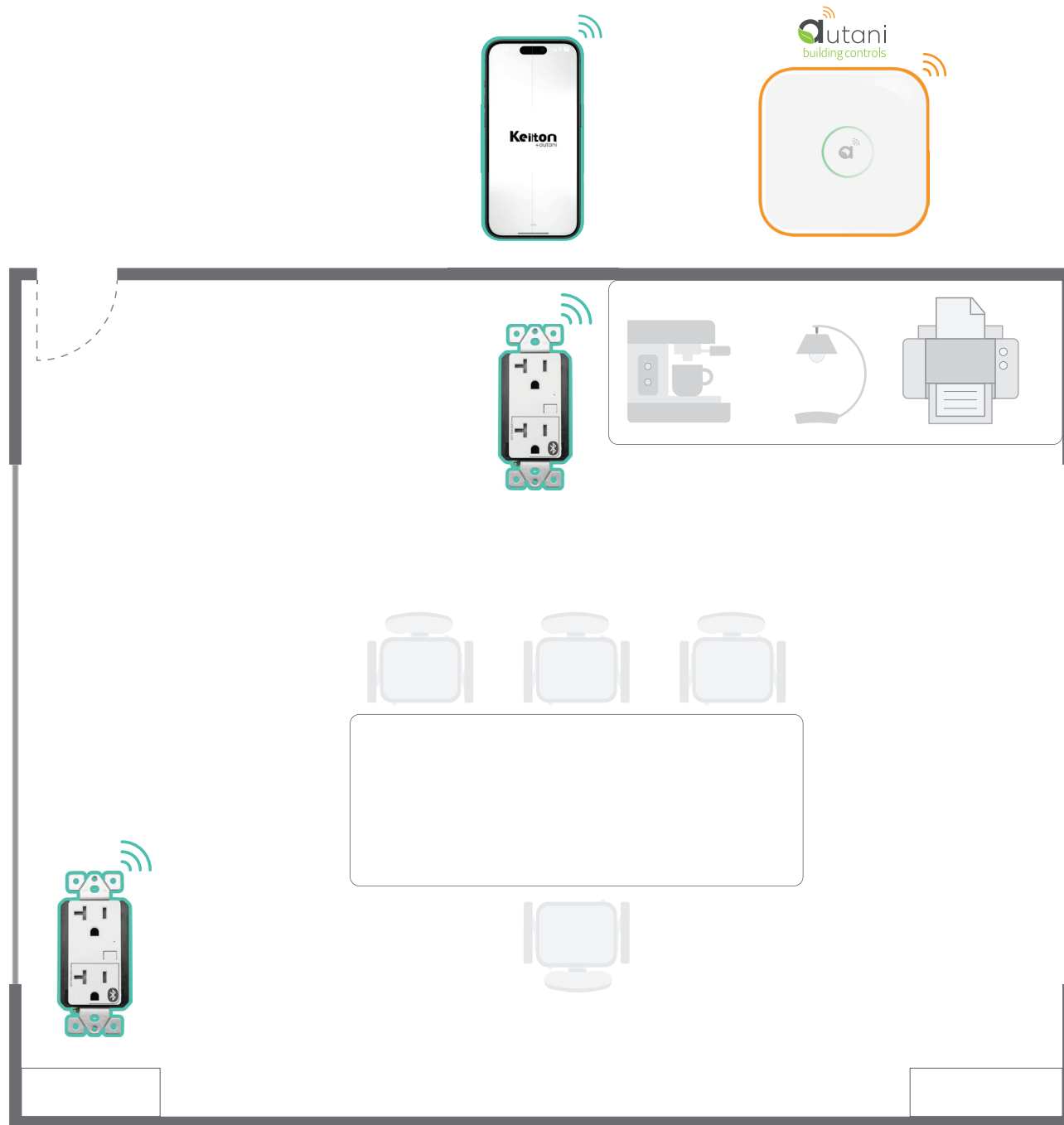

PRODUCT RECOMMENDATIONS

TIER - 02



WF20R.A0 20A Plug Load Bluetooth Controller

- 120VAC
- 20A plug load Bluetooth controller
- Controllable via the Keilton+autani app

TIER - 03



Autani Manager

The Autani Manager is the control processor at the heart of the innovative integrated energy management systems powered by EnergyCenter software. The Manager securely coordinates all energy management functions and provides actionable insights.

CR05.A0 + RTR.A0

- CR05 and RTR devices work in conjunction with the Manager to bring Bluetooth lighting controls into your network.
- Bluetooth network per CR05 may not exceed a radius of 100ft
- Bluetooth network per CR05 may not exceed 4 hops wireless mesh

CONTROL STRATEGIES

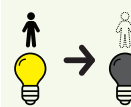

Occupancy / Vacancy Sensing

Turn lights on when occupants are in a space and off when they vacate the space. Alternate Functionality: Partial-on and manual-on modes are supported for additional savings and for more stringent local codes.



High-End Trim | Institutional Tuning

Set the maximum light level based on customer requirements in each space to prevent overlighting.



Daylight Harvesting

Dim lighting when daylight is available. Multiple zones are supported where required by code.



Automatic Scheduling & Timeclock*

Automatically dim or shut off lighting based on centrally managed schedules.

*** Requires Autani Manager or CR02-W.A0.**

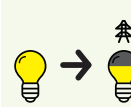

Demand Response*

Manage lighting and electrical loads per utility requirements during periods of high demand.

*** Requires Autani Manager.**



ESTIMATED TOTAL SAVINGS: 20-50%

Alternative Product Recommendations



PPA104S.B1 Line Voltage 20A Bluetooth Zone Control

- 120-277VAC input
- Integrated 20A relay
- Output power up to 2400W (120VAC), 5540W (277VAC)
- UL Plenum Rated
- 1 HP motor load rated

Additional Support

Here is what you
need to know

 For additional support and questions,
please contact us at:

+1 443.320.2233

Autani, LLC
7001 Columbia Gateway Drive
Suite 210
Columbia, MD 21046

 **General Inquiries**
information@autani.com

 **Support**
support@autani.com

 **Applications**
applications@autani.com

 **Quotes**
quotes@autani.com

Please visit us online for additional support

 **Autani Support Center**
<https://autani.zendesk.com/hc/en-us>

 **Online tools and calculators**
www.autani.com/calculators

 **Specifications**
www.autani.com/building-specs/

LiteTrace

Autani, LLC

7001 Columbia Gateway Drive

Suite 210

Columbia, MD 21046

+1 443-320-2233

sales@litetrace.com

www.litetrace.com

www.autani.com

Keilton
+ autani

The logo for Autani building controls features a stylized 'a' with a signal icon above it, followed by the text 'utani' and 'building controls' below.

utani
building controls

WESTGATE
THE FUTURE IS HERE... AND IT'S QUITE BRIGHT!