

ViCloud VMT

Installation Manual

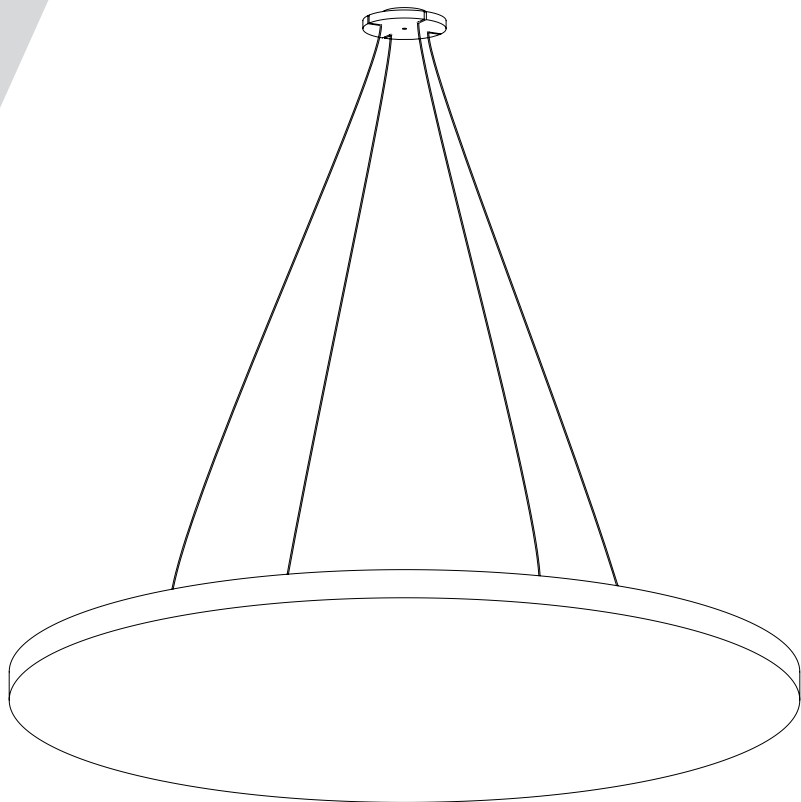

✓ MATERIAL NEEDED

Included

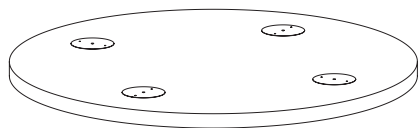

ViCloud x4



Steel Wire Rope x 12/16



Wire Rope Grip x 12/16



Screw x 12/16

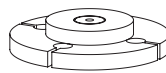

Wooden Base x4

Not Included

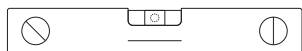

Level

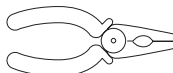

Cutting Pliers



PZ 3x40 Screw

Cloud

Available formats

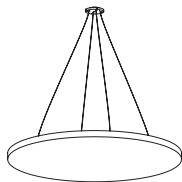

Round

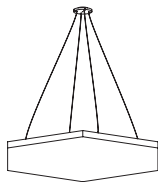

Hexagon

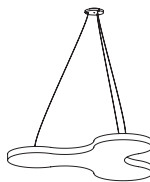

Petal

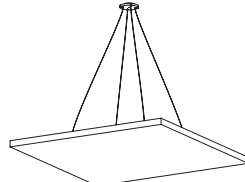

Square

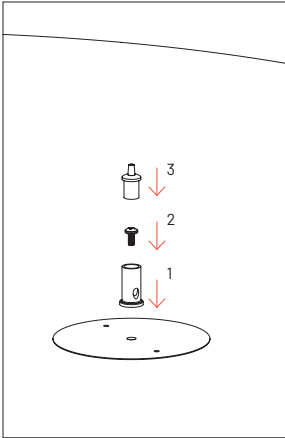
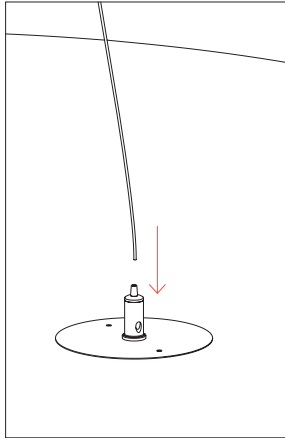
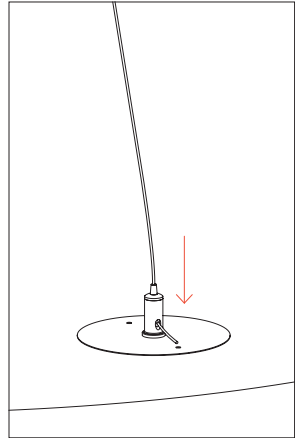
1**1.1****1.2****1.3****2**

Insert the cables in the holes and then screw the wooden base to the ceiling using a screwdriver (not included). In alternative, use the magnetic fixation. Fine tune length of the steel cables to level the ViCloud.

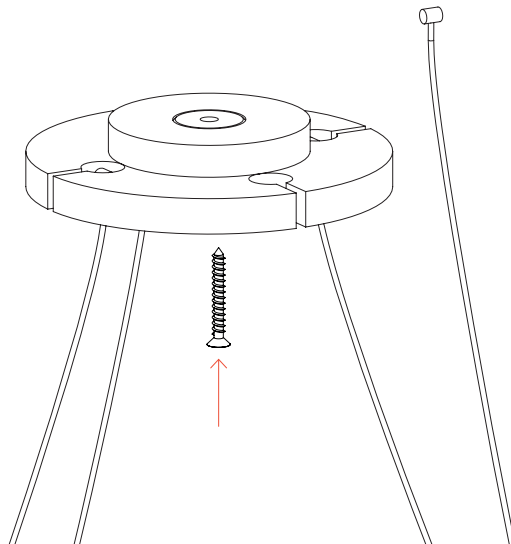
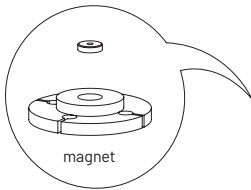

Main Office, R&D & Logistics

Avenida do Pólo 3, N.º 159, Carvalhosa
4590-137 Paços de Ferreira, Portugal
T (+351) 255 136 746

Office

Rua Quinta do Bom Retiro N.º 16, Armazém 9
2820-690 Charneca da Caparica, Portugal
T (+351) 212 964 100

Info and Sales

E sales@vicoustic.com

www.vicoustic.com



© Vicoustic, 2019 | V2

No parts of this document might be copied and/or published without written consent of Vicoustic.