

Model (Single)	Capacity		Resin		Salt Usage		Critical Flow USGPM	105			Max Flow To Drain USGPM	Dimensions		Installation			Shipping Weight lbs	Operating Weight lbs
	@6 lbs/ft3	ft3	@6 lbs/ft3	@10 lbs/ft3	@ 15 PSI	@ 25 PSI		Mineral Tank	Brine Tank	Height		Depth	Width					
	@10 lbs/ft3	m3	lbs	lbs	l/s	l/s		in	in	in		in	in					
105STS 120 -2"	88,000	4	24	40	20	39	56	7	16 x 65	24 x 37	85	31	50	430	1,730			
	108,000	0.11	10.89	18.1	1.26	2.46	3.53	0.44	403 x 1651	610 x 940	2,159	787	1,270	195	785			
105STS 150 -2"	110,000	5	30	50	25	43	61	9	18 x 65	24 x 37	87	32	52	501	1,901			
	135,000	0.14	13.61	22.7	1.58	2.71	3.85	0.57	475 x 1651	610 x 940	2,210	813	1,321	227	863			
105STS 180 -2"	132,000	6	36	60	30	47	68	12	21 x 62	29 x 50	87	36	60	623	2,723			
	162,000	0.17	16.33	27.2	1.89	2.97	4.29	0.76	533 x 1575	740 x 1275	2,210	914	1,524	283	1,235			
105STS 210 -2"	154,000	7	42	70	35	46	66	12	21 x 62	29 x 50	87	36	60	679	2,779			
	189,000	0.20	19.06	31.8	2.21	2.90	4.16	0.76	533 x 1575	740 x 1275	2,210	914	1,524	308	1,261			
105STS 240 -2"	176,000	8	48	80	40	50	71	15	24 x 72	33 x 53	95	40	67	811	3,711			
	216,000	0.23	21.78	36.3	2.52	3.15	4.48	0.95	610 x 1829	840 x 1335	2,413	1,016	1,702	368	1,684			
105STS 270 -2"	198,000	9	54	90	45	49	70	15	24 x 72	33 x 53	95	40	67	866	3,766			
	243,000	0.25	24.50	40.8	2.84	3.09	4.42	0.95	610 x 1829	840 x 1335	2,413	1,016	1,702	393	1,709			
105STS 300 -2"	220,000	10	60	100	48	48	69	15	24 x 72	33 x 53	95	40	67	922	3,822			
	270,000	0.28	27.22	45.4	3.03	3.03	4.35	0.95	610 x 1829	840 x 1335	2,413	1,016	1,702	418	1,734			
105STS 360 -2"	264,000	12	72	120	50	54	76	25	30 x 72	33 x 53	100	40	74	1,065	4,465			
	324,000	0.34	32.67	54.4	3.15	3.41	4.79	1.58	762 x 1829	840 x 1335	2,540	1,016	1,880	483	2,026			
105STS 390 -2"	286,000	13	78	130	54	54	76	25	30 x 72	38 x 55	100	44	78	1,179	5,479			
	351,000	0.37	35.39	59.0	3.41	3.41	4.79	1.58	762 x 1829	965 x 1397	2,540	1,118	1,981	535	2,486			
105STS 450 -2"	330,000	15	90	150	52	52	75	25	30 x 72	38 x 55	100	44	78	1,291	5,591			
	405,000	0.42	40.83	68.1	3.28	3.28	4.73	1.58	762 x 1829	965 x 1397	2,540	1,118	1,981	586	2,537			

LEGEND:

- ✕ ISOLATION VALVE
- ⌘ BYPASS VALVE
- ⊕ PRESSURE GAUGE & SAMPLE POINT
- ↓ OPEN DRAIN
- ⊔ DIAPHRAGM VALVE
- * VACUUM BREAKER
- # FLEX CONNECTORS
- ▬ RAW WATER LINES
- ▬ FILTERED/SOFTENED WATER
- ▬ TREATED WATER LINES
- ⊞ ELECTRIC BALL VALVE

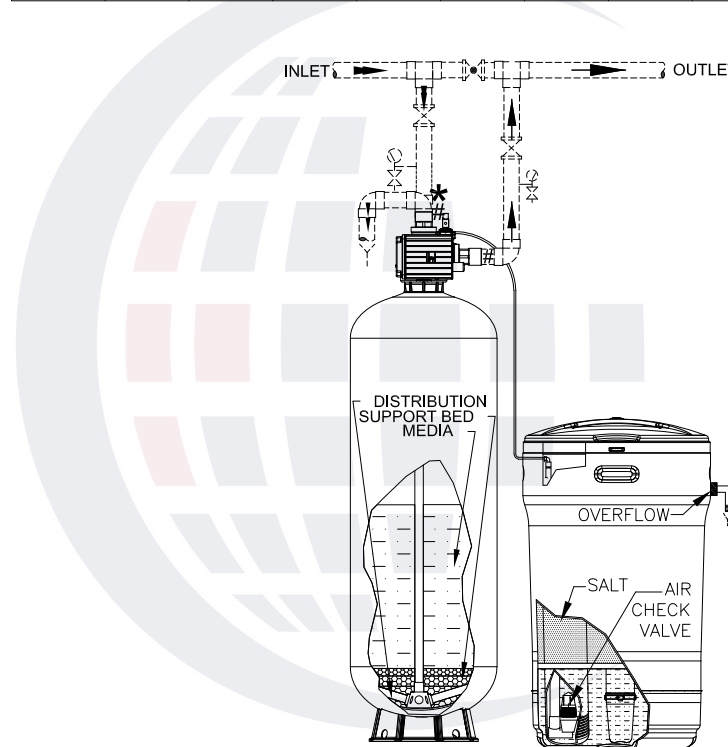

RAW WATER REGENERATION PIPING SHOWN

NOTES:

- SOFTENER(S) EQUIPPED WITH A 105 SERIES ELECTRONIC CONTROL VALVE.
- 2" OR 1.5" NPT CONNECTIONS ARE INTERCHANGEABLE. STANDARD CONNECTION SIZE USED VARIES WITH SOFTENER SIZE (SEE ABOVE TABLE).
- REQUIRES 120 VOLT, 1 PHASE, 60 Hz ELECTRICAL POWER.
- ALL EXTERNAL PIPING, FITTINGS, INTERCONNECTING PIPING, ISOLATION & SAMPLE VALVES AND GAUGES SHOWN BY BROKEN LINES ARE BY OTHERS TANKS AND MEDIA ARE NSF APPROVED.
- RECOMMENDED MINIMUM SYSTEM PRESSURE IS 207 kPa (30 PSI) & MAXIMUM SYSTEM PRESSURE IS 690 kPa (100 PSI). MAXIMUM TEMPERATURE IS 38°C (100°F).
- TRIPOD TANKS TO BE SECURELY ATTACHED TO THE FLOOR.
- MAX FLOW TO DRAIN" IS BASED ON WATER TEMPERATURES OF 4°C (40°F).
- FLOOR DRAINS MUST BE SIZED TO CARRY THE MAXIMUM LISTED FLOW TO DRAIN.
- REFER TO THE INSTALLATION AND OPERATION MANUAL FOR FURTHER DETAILS.
- SYSTEM MUST BE INSTALLED TO COMPLY WITH ALL FEDERAL, STATE, PROVINCIAL AND LOCAL CODES.
- MINIMUM FREE SPACE OF 152 mm (6") REQUIRED ABOVE VALVE.
- DUE TO SLIGHT EXPANSION AND CONTRACTION OF MINERAL TANKS, PIPING MUST BE DESIGNED TO ALLOW SOME MOVEMENT AS WELL AS PROTECTED FROM VACUUM. FLEX CONNECTORS AND A VACUUM BREAKER MAY BE REQUIRED.
- IF USING SYSTEM TREATED WATER REGENERATION, THE BALL VALVE MUST BE INSTALLED ON THE INLET INSTEAD OF THE OUTLET.
- NOTE: IF NEGATIVE PRESSURE EXCEEDS 5" HG (17 kPa), AN ADEQUATE VACUUM BREAKER MUST BE PROPERLY INSTALLED. FAILURE TO INSTALL FLEX CONNECTION PROPERLY, OR IMPROPER INSTALLATION OF A VACUUM BREAKER WHEN REQUIRED, WILL VOID THE WARRANTY.

MODEL: 105 STS 210 -2" S4000

105 STS SINGLE SOFTENER

THIS DOCUMENT CONTAINS INFORMATION WHICH IS PROPRIETARY TO CANATURE WATERGROUP. THE REPRODUCTION, TRANSFER, OR OTHER EXPLOITATION OF ANY INFORMATION CONTAINED HEREIN IS NOT PERMITTED WITHOUT PRIOR WRITTEN APPROVAL OF CANATURE WATERGROUP. THE MANUFACTURER RESERVES THE RIGHT TO MAKE PRODUCT REVISIONS, WHICH MAY DEVIATE FROM THE SPECIFICATIONS AND DESCRIPTIONS STATED HEREIN WITHOUT OBLIGATION TO CHANGE PREVIOUSLY MANUFACTURED PRODUCTS OR TO NOTE THE CHANGE. NOT DRAWN TO THE SCALE UNLESS OTHERWISE SPECIFIED.



Project:	Date: 02/21/2024	Rev
	Dwg# 105 STS 2"S	