



BS-305-XX

SPECIFICATION

- Spout
- Made of solid brass
- Slip-fit installation
- Flow rate: 25L/min [6.6 gpm] @60psi
- Inlet ½in male NPT
- Limited lifetime warranty

FINISHES AVAILABLE

- Refer to the catalog for available finishes

CERTIFICATION

- ASME 112.118.1 / CSA B125.1



For more information about the product or before proceeding to any installation please consult the guide.
Products covered by a limited lifetime warranty against all manufacturing defects.

SPÉCIFICATION

- Bec de bain
- Fabriqué en laiton massif
- Installation Slip-fit
- Débit: 25L/min [6.6 gpm] @60psi
- Connexion ½" mâle NPT

FINIS DISPONIBLE

Se référer au catalogue pour les finis disponible

CERTIFICATION

ASME 112.118.1 / CSA B125.1



Pour plus d'information sur le produit ou avant de procéder à toute installation veuillez consulter le guide.
Produits couverts par une garantie à vie limitée contre tout défaut de fabrication.

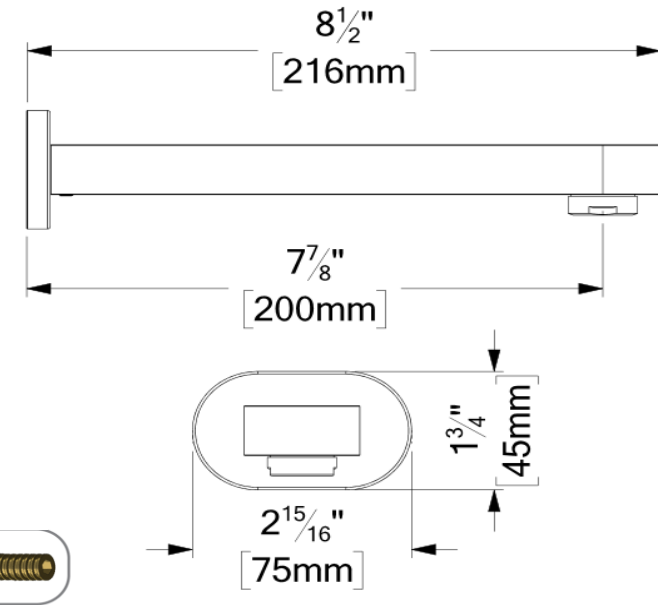
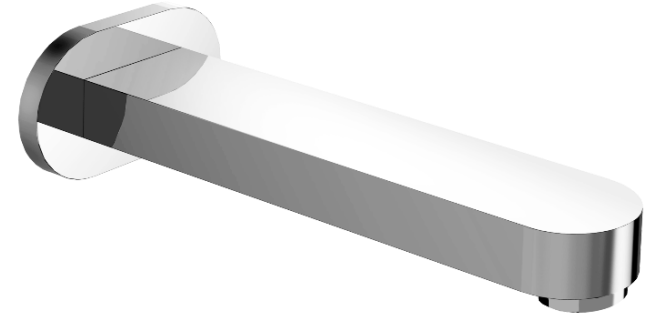

The product may vary slightly from its dimension and appearance.
Les dimensions et l'aspect du produit peuvent varier légèrement de l'illustration