

CATALOGUE 2017

**VECTOR FOG™**  
EXPERTS IN FOGGING TECHNOLOGY™

The logo graphic consists of a white horizontal line that ends in a stylized, multi-lined arrowhead pointing to the right. The arrowhead is composed of several curved lines that create a sense of motion and depth.

[www.vectorfog.com](http://www.vectorfog.com)

# CONTENTS

APPLICATION EQUIPMENT	PAGE	PEST CONTROL EQUIPMENT	PAGE
ULV		BAIT GUN DH1	23
DC20	3	BAIT GUN SET DH2	23
C20	4		
C100+	4	<b>BAIT STATIONS</b>	
C150+	5	B100	24
TU100N	5	B101	24
ULTRAMIST GRAIN SPRAYER	6	B102	25
		B103	25
<b>THERMAL FOGGERS</b>		B105	26
H100	8	B112	26
H100 SF	8	B113	26
H200 SF	9		
H200	10	<b>SNAP TRAPS</b>	
H300 SF	10	B106	27
H400 SF	11	B107	27
H500 SF	11	B108	27
BY100	12		
		<b>RAT CATCHERS</b>	
<b>SPRAYERS</b>		B109	28
BM100	14	B110	28
		B111	28
<b>UV FLY TRAP</b>			
T21/22	15	<b>CAGE TRAPS</b>	
TR01	16	B115	29
VT001	17	B116	29
T10	17	B117	29
<b>SFETY EQUOPMENT</b>		<b>BIRD REPELLENT</b>	
M20	18	BG250	30
M10	19		
M25	19		
M30	20		
M51	20		
COVERALL	22		
GOGGLES	22		
GLOVES	22		



## What is ULV?

Vectorfog™ fogging equipment is used predominately for the application of disinfectants, biocides, fungicides and pesticides. Our foggers generate a fog or mist formed of Ultra Low Volume (ULV) droplets between 5-50 microns ( $\mu\text{m}$ ) in diameter. Studies show that droplets of this size are ideal to tackle pathogens, vector carriers and pests. In addition, formulations can be applied in concentrations of 10-90% and at flow rates of up to 1 litres per minute (60 litres per hour) making them more efficient in the Volume Median Diameter (VMD) spectrum.

# CORDLESS ULV COLD FOGGER DC20

<b>Tank Capacity</b>	2.0 Litres (0.5 Gallon)
<b>Power</b>	220V / 110V
<b>Motor</b>	Mabuchi 170W
<b>Flow Rate</b>	10-20 LPH ( - 5.3 GPH)
<b>Droplet Size</b>	5 - 50 microns
<b>Net Weight</b>	3.1 kg (6.8 lb)
<b>Dimension (cm)</b>	48 x 19 x 22
<b>Dimension (inch)</b>	18.9 x 7.5 x 8.7



Using the latest in battery technology, the DC20 ULV fogger has been specially designed to produce up to 40 min. of continuous fogging time with only 3 hours of charging time. Features include a 2 litre (0.5 gal.) tank, advanced 12V DC motor from MABUCHI MOTOR, one speed control and adjustable droplet size between 5-50 microns. Thanks to its compact design, this fogger is ideal for spraying in smaller spaces including domestic properties as well as food preparation areas, car valets and offices. In addition, the power can be halved reducing noise levels, ideal for hospitals, nursing homes and schools. More technical information on page 6.

## ULV COLD FOGGER C20

<b>Tank Capacity</b>	2.0 Litres (0.5 Gallon)
<b>Power</b>	220V / 110V
<b>Motor</b>	LG 560W
<b>Flow Rate</b>	~20 LPH (~5.3 GPH)
<b>Droplet Size</b>	5 - 50 microns
<b>Net Weight</b>	3.1 kg (6.8 lb)
<b>Dimension (cm)</b>	48 x 19 x 22
<b>Dimension (inch)</b>	18.9 x 7.5 x 8.7



The new C20 is one of the smallest yet powerful ULV foggers in the market. Features include a 2.0 litre (0.5 gal.) tank, a 560 Watt LG motor, outflow of ~20 LPH (~5.3 GPH), adjustable droplet size between 5-50 microns and a two speed output control. Thanks to its compact design, this fogger is ideal for spraying in smaller spaces including domestic properties as well as food preparation areas, car valets and offices. In addition, the power can be halved reducing noise levels, ideal for hospitals, nursing homes and schools. More technical information on page 6.

## ULV COLD FOGGER C100+

<b>Tank Capacity</b>	4 Litres (1 Gallon)
<b>Power</b>	220V / 110V
<b>Motor</b>	LG 1170W
<b>Flow Rate</b>	~60 LPH (~16 GPH)
<b>Droplet Size</b>	5 - 50 microns
<b>Net Weight</b>	3.7 kg (8.2 lb)
<b>Dimension (cm)</b>	52 x 30 x 16
<b>Dimension (inch)</b>	20.5 x 11.8 x 6.3



The compact C100+ cold fogger is one of the most powerful and durable ULV machines in the market today. Equipped with our exclusive 1170 watt motor, this fogger can produce a powerful flow rate between ~60 LPH (~16 GPH) and can easily cover an area of 100 m<sup>2</sup> in less than a minute. With an adjustable droplet size between 5-50 microns, this fogger can quickly apply disinfectants, biocides or insecticides to eradicate vectors, carriers and pests. More technical information on page 6.

# ULV COLD FOGGER

## C150+

<b>Tank Capacity</b>	6 Litres (1.6 Gallon)
<b>Power</b>	220V / 110V
<b>Motor</b>	LG 1170W
<b>Flow Rate</b>	~60LPH (~16 GPH)
<b>Droplet Size</b>	5 - 50 microns
<b>Net Weight</b>	4.7 kg (10.4 lb)
<b>Dimensions (cm)</b>	62 x 31 x 17
<b>Dimension (inch)</b>	24.4 x 12.2 x 6.7



VectorFog’s flagship ULV cold fogger the C150+ is ideal for indoor as well as outdoor applications. With its large 6 litre (1.59 gal.) tank, this fogger can cover a large area without the need of refilling. Thanks to its fully adjustable droplet size between 5-50 microns, this fogger can be used to apply disinfectants, biocides and insecticides in a multitude of locations. With its powerful 1170 Watt LG motor, this fogger will give you years of durability and performance. More technical information on page 6.

# TRUCK MOUNTED ULV COLD FOGGER

## TU100N

<b>Tank Capacity</b>	130 Litres (32.3 Gallon)
<b>Engine</b>	Keyang G710L
<b>Fuel</b>	Petrol
<b>Fuel Tank</b>	5 Litres (1.32 Gallon)
<b>Actual Range</b>	8 (26.2 ft.)
<b>Net Weight</b>	90 kg (198.4 lb)
<b>Dimension (cm)</b>	111 x 72 x 76
<b>Dimension (inch)</b>	43.7 x 28.3 x 29.9



The Vectorfog™ truck mounted ULV cold fogger TU100N is ideal for large scale applications including vector control and agricultural fumigation. Features include a 7.0Hp Keyang engine, 130 litres (34.3 gal.) tank, a head with 3 nozzles and a remote control. With a horizontal spray distance of 8 metres (26.2 ft.), this fogger will be able to spray a large area in the minimum amount of time.

# ULTRA MIST ULV GRAIN SPRAYER



<b>Tank Capacity</b>	8 Litres (2.1 Gallon)
<b>Voltage</b>	220V / 110V - 50Hz
<b>Air Compressor</b>	Samsung 4.8kW
<b>Flow Rate</b>	60LPH
<b>Droplet Size</b>	1- 5 microns
<b>Net Weight</b>	3.5 kg (7.7 lb)
<b>Dimension (cm)</b>	52 x 30 x 16
<b>Dimension (inch)</b>	20.5 x 11.8 x 6.3
<b>Materials</b>	Chemical tank : Acid tolerant rubber(inside) Urethane 4mm(outside) Hose : Urethane Frame : Steel

Vectorfog’s Ultra Mist ULV sprayer is ideal for applying grain protectant such as K-Obiol prior to grain storage. The ULV nozzle can be placed on a combine harvester, feeder or conveyor to apply the protectant. Features include a 1-5 micron nozzle, Samsung compressor (version without is also available) and an outflow of 1 LPH (0.26 GPH).

## TECHNICAL DATA

				
	<b>DC20</b>	<b>C20</b>	<b>C100+</b>	<b>C150+</b>
Power	Rechargeable battery 110V/220V	Electric Power 110V/220V	Electric Power 110V/220V	Electric Power 110V/220V
Motor	Mabuchi Motor	LG motor	LG motor	LG motor
Performance	170 Watt	560 Watt	11700 Watt	11700 Watt
Tank capacity	2.0 L (0.5 Gal.)	2.0 L (0.5 Gal.)	4 L (1 Gal.)	6 L (1.6 Gal.)
Chemicals	Oil & Water based Chemicals	Oil & Water based Chemicals	Oil & Water based Chemicals	Oil & Water based Chemicals
Flow rate	10-20 LPH (2.6 - 5.3 GPH)	~20 LPH (~5.3 GPH)	~60 LPH (~16 GPH)	~60 LPH (~16 GPH)
Droplet size	5 - 50 microns	5 - 50 microns	5 - 50 microns	5 - 50 microns
Spray distance <sup>1</sup>	2-5 meters (6.6-16.4 ft.)	2-7 meters (6.6-23 ft.)	5-10 meters (16.4-32.7 ft.)	5-10 meters (16.4-32.7 ft.)
Net weight	3.1 kg (6.8 lb)	3.1 kg (6.8 lb)	3.7 kg (8.2 lb)	4.7 kg (10.4 lb)
Dimension (cm)	48 x 19 x 22	48 x 19 x 22	52 x 30 x 16	62 x 31 x 17
Dimension (inch)	18.9 x 7.5 x 8.7	18.9 x 7.5 x 8.7	20.5 x 11.8 x 6.3	24.4 x 12.2 x 6.7
Features	- 1 speed output control - Strap for easy carriage	- 2 speed output control - Strap for easy carriage	- 2 speed output control - Strap for easy carriage	- 2 speed output control - Strap for easy carriage

<sup>1</sup> Horizontal, in conditions with no wind

# THERMAL FOGGERS

## SF Technology

Our SF thermal foggers are designed for the application of water and oil based solutions. Thanks to their unique and patented Dual-Point™ inlet technology, our foggers are one of the most versatile and durable foggers in the market today. Simply turn a valve to switch between water and oil based fogging.

This year the SF range will also come with additional options including a manual start only, auto start (standard), and dual start. A materials option will also be available this year, including an all stainless steel option for applying more corrosive chemicals.



## DOD TEST

### WATER + NIS RESULT

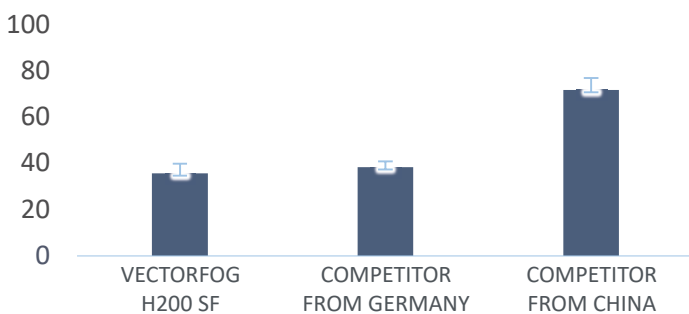

This year our H200SF was tested by the US Navy Entomology Centre to evaluate the droplet size of our machines in the Volume Medium Diameter (VMD) spectrum. Using a laser diffraction spectral analyser under DV 0.5 conditions, our H200SF showed to perform considerably better than Chinese and American brands and in par, if not slightly better than brands from Germany. Our fogger also came on top in the water fogging test achieving the smallest droplet size of all the thermal foggers ever tested by the DOD.

Thermal Fog Machine		(µm ± SD)		
VECTORFOG H200 SF	Water + NIS	11.8 ± 1.1	35.6 ± 4.2	95.3 ± 22.7
	BVA 13 Oil	1.2 ± 0.0	3.7 ± 0.1	8.1 ± 0.3
COMPETITOR FROM GERMANY	Water + NIS	18.5 ± 1.4	38.3 ± 2.5	64.8 ± 5.7
	BVA 13 Oil	1.2 ± 0.1	3.9 ± 0.4	14.0 ± 9.7
COMPETITOR FROM CHINA	Water + NIS	24.5 ± 2.1	71.7 ± 5.2	154.8 ± 8.3
	BVA 13 Oil	1.2 ± 0.0	4.2 ± 0.0	8.9 ± 0.0

# PORTABLE THERMAL FOGGER H100

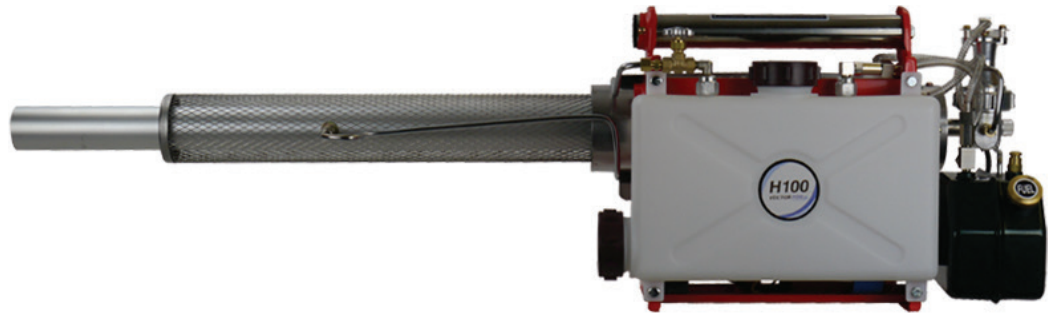

Tank Capacity	Fuel	Engine	Droplet Size	Net Weight	Dimensions
4.5 Litres (1.2 gal.)	Petrol	Pulse Jet	5 - 30 microns	8.5 kg (18.7 lb)	115 x 34 x 25 cm (45.3 x 13.4 x 10 inch)

This portable thermal fogger is ideal for a wide range of uses including vector and pest control applications. Features include a 4.5 plastic tank, a flow rate of 40 LPH (10.6 GPH) and automatic start. With a net weight of only 8.5 litres (2.25 gal.), the H100 is capable of dispersing disinfectants and insecticides quickly and effectively in a variety of locations including parks, warehouses, greenhouses, factories, farms, poultry houses, silos and more. More technical information on page 13.

# PORTABLE THERMAL FOGGER H100 SF

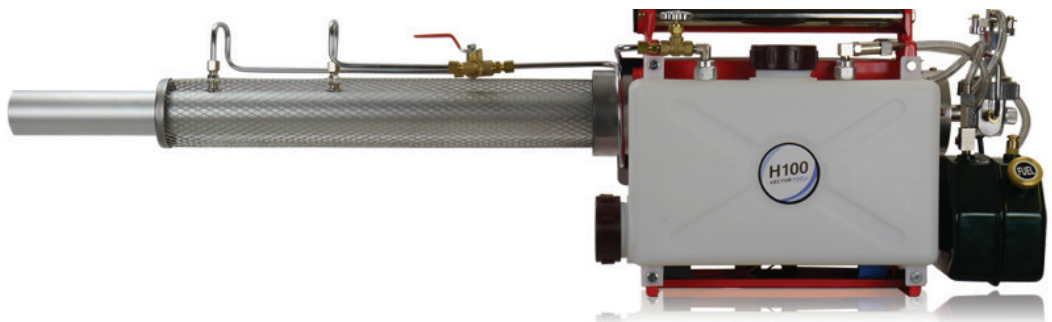

Tank Capacity	Fuel	Engine	Droplet Size	Net Weight	Dimensions
4.5 Litres (1.2 gal.)	Petrol	Pulse Jet	5 - 30 microns	8.5 kg (18.7 lb)	115 x 34 x 25 cm (45.3 x 13.4 x 10 inch)

With two inlet pipes, the H100SF thermal fogger is a dual purpose fogger especially designed for applying water as well as oil based solutions. Features include a 4.5 plastic tank, a flow rate of 40 LPH (10.6 GPH) and automatic start. With a net weight of only 8.5 litres (2.25 gal.), the H100 is capable of dispersing disinfectants and insecticides quickly and effectively in a variety of locations such as parks, warehouses, greenhouses, factories, farms, poultry houses, silos and more. More technical information on page 13.



# PORTABLE THERMAL FOGGER H200 SF

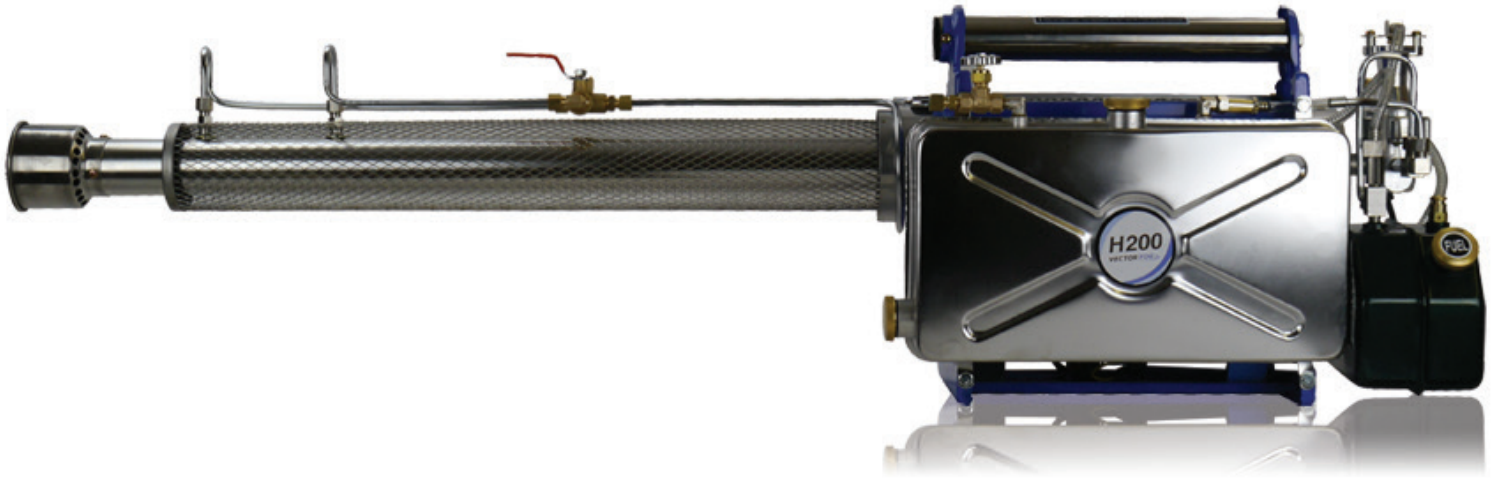

Tank Capacity	Fuel	Engine	Droplet Size	Net Weight	Dimensions
6.5 Litres (1.7 gal.)	Petrol	Pulse Jet	5 - 30 microns	10.8 kg (23.8 lb)	133 x 28 x 38 cm (52.4 x 11 x 15 inch)

The new Vectorfog H200SF has been specially designed for the application of water and oil based solutions. With its unique Dual-Point™ inlet technology and a specially designed nozzle for enhanced dispersion, this versatile fogger will allow you to tackle any job from plant protection and animal health disinfection to the control of vector carriers and pests. As with the H200 model, this fogger features include a 6.5 Stainless steel tank, a flow rate of 50 LPH and automatic start. This fogger has also been manufactured using high grade stainless steel providing the users with years of durability and performance. More technical information on page 13.

## THERMAL FOGGER OPTIONS

For tenders and high volume orders, we can customize our products to suit customer’s individual requirements, including oil and water based fogging solutions, angle adjustment, chemical resistant materials and machine starting options. For more information, please speak to one of our sales representatives.

TYPE
SF
Oil
Water

MATERIAL
Stainless Steel
Brass

START
Dual
Auto
Manual

## PORTABLE THERMAL FOGGER H200

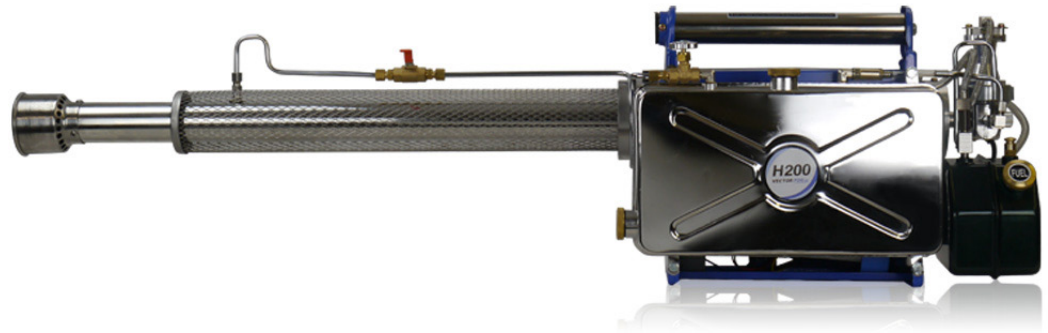

Tank Capacity	Fuel	Engine	Droplet Size	Net Weight	Dimensions
6.5 Litres (1.7 gal.)	Petrol	Pulse Jet	5 - 30 microns	10.8 kg (23.8 lb)	133 x 28 x 38 cm (52.4 x 11 x 15 inch)

Manufactured with durability and resistance in mind, this portable thermal fogger is made out of high grade stainless steel. As well as resistance to corrosion and heat, this superior steel is also resistant to oil based chemicals, hydrogen peroxide, kerosene and acids. Features include a 6.5 stainless steel tank, a flow rate of 50 LPH (13.2 GPH) and automatic start. Thanks to its simple, durable and efficient design, this thermal fogger will provide you years of durability and performance. More technical information on page 13.

## QUAD BIKE MOUNTED THERMAL FOGGER H300 SF

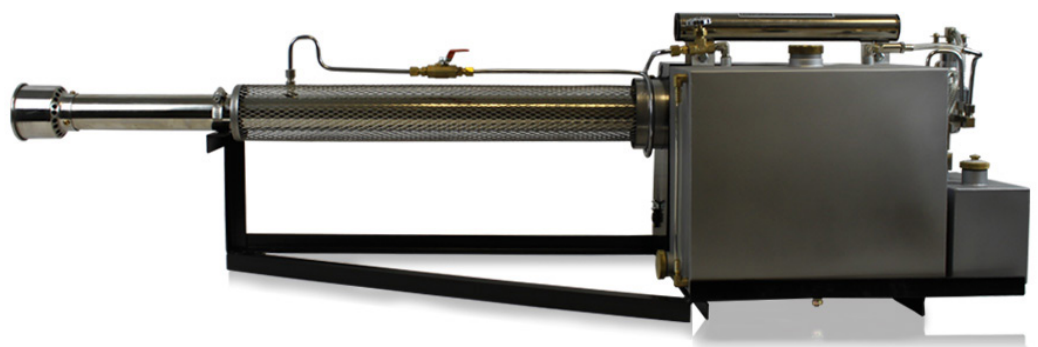

Tank Capacity	Fuel	Engine	Droplet Size	Net Weight	Dimensions
13.5 Litres (3.6 gal.)	Petrol	Pulse Jet	5 - 30 microns	20 kg (44 lb)	Made to Measure

Designed to be fitted to the back of a motorbike or quad-bike, the H300 is the ideal fogger for fast dispersion of disinfectants or insecticides in towns and farms. Features include 13.5 litre (3.6 gal.) tank, automatic start and a powerful outflow of 52 LPH (13.7 GPH). It can also be custom built to fit customer's specific requirements. More technical information on page 13.

## TROLLY MOUNTED THERMAL FOGGER H400 SF



Tank Capacity	Fuel	Engine	Droplet Size	Net Weight	Dimensions
30 Litres (6.1 gal.)	Petrol	Pulse Jet	5 - 30 microns	36 kg (79.4 lb)	165 x 110 x 58 cm (65 x 43.3 x 23 inch)

The Vectorfog H400 SF trolley mounted thermal fogger is ideal for medium size fogging applications and it's perfect in locations where access to vehicles is limited. Features include a 23 litre (6.1 gal.) stainless steel tank, a flow rate of 50-80 LPH (13.2 - 21.1 GPH) and automatic start. Thanks to its large chemical tank, this thermal fogger can be used for long periods at a time without the need to refill. More technical information on page 13.

## TRUCK MOUNTED THERMAL FOGGER H500 SF

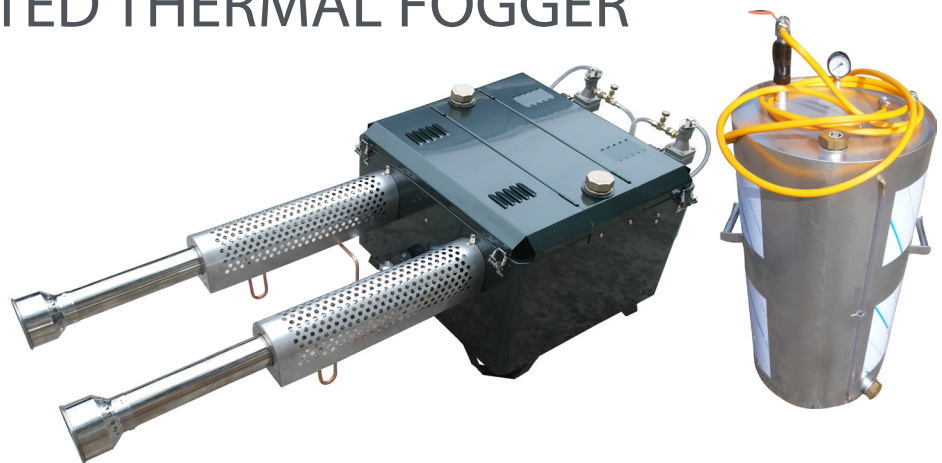

Tank Capacity	Fuel	Flow Rates	Droplet Size	Net Weight	Dimensions
150 Litres (40 gal.)	Petrol	200-300 LPH(53-80 GPH)	5 - 30 microns	120 kg (265 lb)	165 x 72 x 80 cm (65 x 28.3 x 31.5 inch)

The Vectorfog H500 SF truck mounted thermal fogger is ideal for large fogging applications including vector control and agricultural fumigation. Features include a large 150 litre (40 gal.) stainless steel tank, duel resonator, remote control and a flow rate of 200 – 300LPH (53 - 80 GPH). Thanks to its powerful flow rate, this thermal fogger can quickly cover a large area in the minimum amount of time. More technical information on page 13.

# PORTABLE THERMAL FOGGER BY100









Tank Capacity	Fuel	Type	Droplet Size	Net Weight	Dimensions
2.8 Litres (0.74 Gal.)	Gas/Propane	Cartridge	5 - 30 microns	1.7 kg (3.75 lb)	61 x 17.5 x 40 cm (24 x 6.9 x 15.7 inch)



**VectorFog™ Mini Foggers** are powered by a standard propane or butane gas cartridge. The water or oil dilutant is heated and then mixed with the chemical at the last moment to create a fog or mist. Features include a 2.8 Litre tank, flow rate of 2 LPH and strap for portability. The Mini fogger is ideal for fogging pesticides and disinfectants in locations with no access to electricity including patios, parks, silos, chicken coops and greenhouses. More technical information on page 13.

## TECHNICAL DATA

							
	<b>BY100</b>	<b>H100/H100SF</b>	<b>H200/H200SF</b>	<b>H300SF</b>	<b>H400SF</b>	<b>H500SF</b>	
<b>Type</b>	Portable	Portable	Portable	Quad/Bike Mounted	Trolley Mounted	Truck Mounted	
<b>Application</b>	Oil & Water based Chemicals	H100: Oil Based Chemicals only H100SF: Water & Oil based chemicals	H200: Oil Based Chemicals only H200SF: Water & Oil based chemicals	Water & Oil based Chemicals	Water & Oil based Chemicals	Water & Oil based Chemicals	
<b>Maximum flow rate of oil based solutions</b>	2 lph (0.53 gph)	40 lph	50 lph	60 lph	80 lph	200 - 300 lph	
<b>Average flow rate with water (SF Models only)</b>	N/A	30 lph	40 lph	45 lph	50 lph	110 lph	
<b>Solution Tank Capacity</b>	2.8 L (0.47 gal.)	4.5 L	6.5 L	15 L	30 L	150 L	
<b>Solution Tank Capacity (oz.)</b>	95	152	220	507	1014	5072	
<b>Solution tank pressure</b>	0.15 kgf / cm <sup>2</sup> (2.13 PSI, 0.147 bar)	0.15 kgf / cm <sup>2</sup> (2.13 PSI, 0.147 bar)	0.15 kgf / cm <sup>2</sup> (2.13 PSI, 0.147 bar)	0.15 kgf / cm <sup>2</sup> (2.13 PSI, 0.147 bar)	0.15 kgf / cm <sup>2</sup> (2.13 PSI, 0.147 bar)	0.15 kgf / cm <sup>2</sup> (2.13 PSI, 0.147 bar)	
<b>Droplet size</b>	5 - 30 microns	5 - 30 microns	5 - 30 microns	5 - 30 microns	5 - 30 microns	5 - 30 microns	
<b>Motor</b>	N/A	Pulse Jet Engine	Pulse Jet Engine	Pulse Jet Engine	Pulse Jet Engine	Pulse Jet Engine	
<b>Fuel tank capacity</b>	Butane Gas Cartridge	1.2 L (0.32 Gal.)	1.2 L (0.32 Gal.)	2.4 L (0.64 Gal.)	3.2 L (0.85 Gal.)	15 L (7.5 L x 2)	
<b>Fuel consumption</b>	N/A	1.2 lph	1.2 lph	1.8 lph	1.8 lph	4.3 lph	
<b>Fuel type</b>	Gas/Propane Gas	Unleaded Petrol	Unleaded Petrol	Unleaded Petrol	Unleaded Petrol	Unleaded Petrol	
<b>Performance of combustion chamber<sup>1</sup></b>	N/A	19 kW / 25.5 hp	19 kW / 25.5 hp	21 kW / 28.2 hp	23 kW / 30.8 hp	46 kW / 61.7 hp	
<b>Spray distance (horizontal)<sup>2</sup></b>	8 - 10 metres (26.2 - 32.8 ft.)	15 - 20 metres (49.2 - 65.6 ft.)	20 - 25 metres (65.6 - 82 ft.)	25 - 30 metres (82 - 98.4 ft.)	30 - 40 metres (98.4 - 131.2 ft.)	20 - 40 metres	
<b>Spray distance with water base (horizontal)<sup>2</sup></b>	8 metres (26.2 ft.)	8 metres (26.2 ft.)	9 metres (29.5 ft.)	11 metres (36.1 ft.)	12 metres (39.4 ft.)	15 metres	
<b>Power supply</b>	6V Rechargeable Battery	6V Rechargeable Battery	6V Rechargeable Battery	6V Rechargeable Battery	6V Rechargeable Battery	12V Rechargeable Battery	
<b>Dimension (cm)</b>	61 x 17.5 x 40	115 x 34 x 25	133 x 28 x 38	Build to fit Customer's requirements	165 x 110 x 58	162 x 72 x 80	
<b>Dimension (inch)</b>	24 x 6.9 x 15.7	45.3 x 13.4 x 9.8	52.4 x 11 x 15	Build to fit Customer's requirements	65 x 43.3 x 22.8	63.8 x 28.3 x 31.5	
<b>Net Weight (kg)</b>	1.7	8.5	10.8	15	36	150	
<b>Net Weight (lb)</b>	3.75	18.7	23.8	33	79.4	330.7	

<sup>1</sup> Theoretical value based on the energy of consumed fuel

<sup>2</sup> In conditions with no and chemical dependent

<sup>3</sup> Excluding tank

# BACKPACK MOTORISED MIST SPRAYER

## BM100

<b>Tank capacity</b>	16 Litres (4.2 gal.)
<b>Engine</b>	Air-cooled 2-stroke Gasoline engine
<b>Displacement</b>	40cc
<b>Spray distance</b>	20 Metres (65.6 ft)
<b>Starting system</b>	Standard recoil
<b>Dimension (cm)</b>	41.5 x 50.5 x 71
<b>Dimension (inch)</b>	91.5 x 111.3 x 156.5
<b>Weight</b>	10.6 kg (23.4 lb)
<b>Application range</b>	2600m <sup>2</sup>



## Backpack Motorised Mist Sprayer

The BM 100 mist blower is ideal for plant and crop protection as well as pest control applications. Powered by specially designed air cooled 2 stroke 40 cc engine manufactured in Korea, this mist blower has a powerful fan achieving a spray distance of 20 metres. The BM 100 mist sprayer produces droplet sizes below 60 microns ideal for insect control. Thanks to its large 16 litre tank, the BM 100 can cover an area of 1600 m<sup>2</sup> (outdoors) and 2600m<sup>2</sup> (indoors). This light weight mist blower features include ergonomic back and padded shoulder straps, anti-vibration mounts, recoil start, and an electronic transistorized ignition module.



# VECTORTRAP

## FLY TRAP T21&T22 UV Glue Board Fly Killer

<b>BL Lamps</b>	T21: 2 x Osram Ultraviolet 36W T22: 3 x Osram Ultraviolet 36W
<b>Consumption</b>	T21: 72W T22: 108W
<b>Effective Area</b>	45 m <sup>2</sup> - 60 m <sup>2</sup>
<b>Electricity</b>	110V/220V, 60Hz
<b>Application</b>	Indoor Use
<b>Dimension (cm)</b>	53 x 32 x 12
<b>Dimension (inch)</b>	21x 12.6 x 4.7

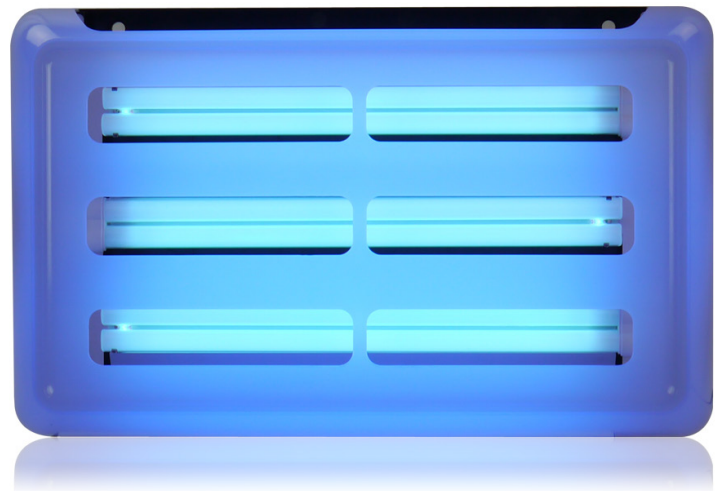

### Superb, Compact Fly Killer

The VectorTrap T21 & T22 flying insect traps are one of the most powerful glue traps on the market today. Thanks to their high power Osram UV lights, translucent cover, and specially engineered aluminum reflectors to increase UV light intensity. These traps will lure any flying insect to the trap in a matter of seconds. This trap is FDA compliant and assists with HACCP monitoring.

### Osram UV Lamp

With an optimized UVA spectrum matching the eye sensitivity of the housefly, Actinic BL lamps are perfect for attracting insects.



# MOSQUITO FLY RACKET

## TR01

<b>Body Material</b>	ABS
<b>Mesh Wire</b>	Good rust resistance
<b>Input Voltage</b>	3V DC
<b>Output Voltage</b>	7000 V
<b>Power</b>	1.5V-2xAAA battery
<b>Static Voltage of Net</b>	0 V
<b>Size</b>	51.5 x 20 x 20 cm 20.3 x 7.9 x 7.9 inch
<b>Racket Size</b>	25 x 20 cm 10 x 8 inch
<b>Weight</b>	295 g (0.65 lb.)
<b>Colour</b>	White-Pink/ Red-Black



## Battery Powered, Intelligent Vectorfog Mosquito Fly Racket

Vectorfog Mosquito Fly Racket is a new, highly efficient fly killing swatter. This fly racket is ideal to kill any size of insects including mosquitoes, flies, moths, spiders, cockroaches, etc. without the need of chemicals, sprays or electric power supply. This swatter is made using high quality ABS for the handle and galvanised wire for the net layers.

## Features

This battery powered fly zapper uses its double-layered electric wire screens to absorb pests instantly without dropping and leaving any mess. Features include a power indicator light, a LED light with its switch and a cleaning brush to limit contact with mess on the net.

- **High Voltage:** At least 3,000 Voltage of instant electric shock is required to kill mosquitoes and this swatter with 7,000V can kill cockroaches, spiders, moths, flies and mosquitoes.
- **Safe To Touch:** Two layers of positive and negative electrode make safe product for children and pets. The power automatically stops with no residual electricity in the net.
- **Easy Control:** Batteries are easily replaced and light weight of 295g (0.65 lb.) helps users to carry and control the racket easily.
- **Durability:** The body is made of ABS material with ultrasonic welding technology. Unique two layered nets are galvanized for rust resistance.
- **LED Light:** The super bright LED light gives you a focus light and you can also use it in dark.







## INSECT TRAP

### VT001

<b>Type</b>	Glue Roll Insect Trap
<b>Dimension (cm)</b>	Ø 20, 100m roll
<b>Dimension (inch)</b>	Ø 8, 328ft roll
<b>Colour</b>	Yellow
<b>Applications</b>	Green houses, Livestock farms, Orchards

Designed for use in greenhouses, livestock farms and orchards, this double sided sticky roll trap is ideal for attracting and trapping small flying insects including whiteflies, aphids, sciarids and phorids. The yellow colour it emits is irresistible to these flying insects and acts as a powerful attractant. Made with a special hi-tech glue, this trap is also water resistant and guaranteed to remain sticky for up to 1 year. This trap is 100 meters (328 ft.) long and should be hung horizontally above the crop just after crop emergence. Fit around the sides of the greenhouse or between row.



## INSECT TRAP

### T10

<b>Size (cm)</b>	Ø 24 x 32
<b>Size (cm)</b>	Ø 9.5 x 12.6
<b>Consumption</b>	22W
<b>Effective Area</b>	100m <sup>2</sup> ~ 150m <sup>2</sup>
<b>Electricity</b>	220V, 60Hz
<b>BL Lamps</b>	4W x 2 (Quartz)
<b>Material</b>	ABS

Ideal for indoor as well as outdoor applications the Vectortrap™ T10 trap works by luring the flying insects to the trap via UV light & CO2 gas. Once the insects are in catching distance, an electric fan sucks the insects into a mesh cage which contains a glue board. This UV system is also less noisy and cleaner than conventional ultraviolet zappers. Our trap is ideal for restaurants, patio areas and greenhouses.

# SAFETY EQUIPMENT

## RESPIRATOR MASK

### M20

<b>Type</b>	Full Face Mask
<b>Environment</b>	Medium Gas Density
<b>Material</b>	Elastomeric Silicon
<b>Cartridges Available</b>	Organic gas, multi-purpse, ammonia, halogen, sulphurous acid, hydrogen sulphide
<b>Certificates</b>	KOSHA, EN136, EN141
<b>Dimension (cm)</b>	24 x 13 x 32
<b>Dimension (inch)</b>	9.5 x 5.1 x 12.6



## Solid, Durable Fullface Mask

Suitable for protecting in medium gas density environments, the M20 Full Face Mask can be used to protect against most common pesticides as well as more toxic fumigants such as Methyl Bromide, Sulphuryl Flouride, Methyl Iodide and Phosphine gas (PH3).

## Vectorfog Mask **Features**



01.  
180° Wide Angle Lens



02.  
Anti-Mist Function



03.  
Heavy Duty Canister



04.  
Non-Toxic Silicon

## RESPIRATOR MASK

### M10

<b>Type</b>	Full Face Mask
<b>Environment</b>	Low Gas Density
<b>Material</b>	Elastomeric Silicon
<b>Cartridges Available</b>	Organic gas, multi-purpse, ammonia, halogen, sulphurous acid, hydrogen sulphide
<b>Certificates</b>	KOSHA, EN136, EN141
<b>Dimension (cm)</b>	24 x 13 x 32
<b>Dimension (inch)</b>	9.5 x 5.1 x 12.6



Suitable for protecting in low gas density environments, the M10 Full Face respirator mask can be used to protect against most common organic pesticides such as Pyrethroids. Note: This respirator mask is not suitable for protecting against more toxic fumigants such as Aluminium and Magnesium Phosphide which produce Phosphine gas (PH<sub>3</sub>). For protection against PH<sub>3</sub>, please use our M20 or M25 mask with a halogen filter.

## RESPIRATOR MASK

### M25

<b>Type</b>	Full Face Mask
<b>Environment</b>	Medium Gas Density
<b>Material</b>	Elastomeric Silicon
<b>Cartridges Available</b>	Organic gas, multi-purpse, ammonia, halogen, sulphurous acid, hydrogen sulphide
<b>Certificates</b>	KOSHA, EN136, EN141
<b>Dimension (cm)</b>	24 x 13 x 32
<b>Dimension (inch)</b>	9.5 x 5.1 x 12.6



Suitable for protecting in medium gas density environments, the M25 Full Face Mask can be used to protect against most common pesticides and agro-chemical fumigants as well as more toxic fumigants such as Methyl Bromide, Sulphuryl Flouride, Methyl Iodide and Phosphine gas (PH<sub>3</sub>).

# RESPIRATOR MASK

## M30

<b>Type</b>	Half Face Mask
<b>Environment</b>	Low Gas Density
<b>Material</b>	Elastomeric Silicon
<b>Cartridges Available</b>	Dust and Organic vapours
<b>Certificates</b>	KOSHA, EN136, EN141
<b>Dimension (cm)</b>	24 x 13 x 32
<b>Dimension (inch)</b>	9.4 x 5.1 x 12.2



This mask is a dual purpose mask suitable for protecting against dust and low volume organic vapours. It is suitable for protecting against most disinfectants and organic pesticides such as Pyrethroids in low concentrations.

# RESPIRATOR MASK



## M51

<b>Type</b>	Air Supplied
<b>Environment</b>	High gas density & Dust
<b>Material</b>	Elastomeric Silicon
<b>Cartridges Available</b>	Air Purifying
<b>Certificates</b>	KOSHA, EN136, EN141



Suitable for protecting in high gas density environments, the M51 Air Line supplied Full Face Mask can protect when high concentrations toxic gases are present, such as Phosphine gas (Ph<sub>3</sub>) and Carbon Monoxide (CO). Features of this mask include a 180° wide angle lens, anti-mist technology and a elastomeric head strap and mouth piece for a comfortable and secure fit. This kit includes a filter cartridge, vest, air supply tube and a compressor. This mask and canisters are certified by the Korean Occupational Safety Agency (KOSHA). Other standards include EN136 and EN141.

# TECHNICAL DATA

					
	<b>M10</b>	<b>M20</b>	<b>M25</b>	<b>M30</b>	<b>M51</b>
Eye protection	Yes	Yes	Yes	N/A	Yes
Canister type	Dual	Isolated	Isolated	Dual	Isolated
Environment	Low Gas Density	Medium Gas Density	Medium Gas Density	Low Gas Density	High Gas Density & Dust
Cartridge available	<ul style="list-style-type: none"> <li>- Organic Gas</li> <li>- Ammonia</li> <li>- Sulphurous</li> <li>- Acid Halogen</li> <li>- Multi-Purpose</li> </ul>	<ul style="list-style-type: none"> <li>- Organic Gas</li> <li>- Ammonia</li> <li>- Sulphurous Acid</li> <li>- Halogen</li> <li>- Hydrogen Sulphide</li> <li>- Multi-Purpose</li> </ul>	<ul style="list-style-type: none"> <li>- Organic Gas</li> <li>- Ammonia</li> <li>- Sulphurous Acid</li> <li>- Halogen</li> <li>- Hydrogen Sulphide</li> <li>- Multi-Purpose</li> </ul>	Dust & Organic Vapours	Air Purifying
Breathe in resistance Minimum requirement	30 L/min : less than 50 Pa 95 L/min : less than 150 Pa	30 L/min : less than 50 Pa 95 L/min : less than 150 Pa	30 L/min : less than 50 Pa 95 L/min : less than 150 Pa	30 L/min : less than 50 Pa 95 L/min : less than 150 Pa	50 L/min
Breathe out resistance	9Pa 41.2 Pa	9.6 Pa 73.2 Pa	11 Pa 80.9 Pa	2.7 Pa 8.2 Pa	71 L/min
Breathe out resistance Minimum requirement	160 L/min: less than 300 Pa	160 L/min: less than 300 Pa	160 L/min: less than 300 Pa	160 L/min: less than 300 Pa	100 L/min
Breathe out resistance	246 Pa	101.4 Pa	161.6 Pa	189 Pa	100 L/min
Power	N/A	N/A	N/A	N/A	220V
Power consumption	N/A	N/A	N/A	N/A	600 W / 60HZ
Lens	180 wide angle	180 wide angle	180 wide angle	N/A	180 wide angle
Face seal material	Elastomeric Silicon	Elastomeric Silicon	Elastomeric Silicon	Elastomeric Silicon	Elastomeric Silicon
Certificates	KOSHA, EN136, EN141	KOSHA, EN136, EN141	KOSHA, EN136, EN141	KOSHA, EN136, EN141	KOSHA, EN136, EN141
Dimension (cm)	24 x 13 x 31	24 x 13 x 31	24 x 13 x 31	24 x 13 x 31	24 x 13 x 31
Dimension (inch)	9.5 x 5.1 x 12.6	9.5 x 5.1 x 12.6	9.5 x 5.1 x 12.6	9.5 x 5.1 x 12.6	9.5 x 5.1 x 12.6
Speaking diaphragm	Yes	Yes	Yes	N/A	Yes
Six-point head harness	Yes	Yes	Yes	N/A	Yes
Net weight (kg)	0.9	0.8	1.2	0.3	1.5
Net weight (lb)	2	1.8	2.6	0.7	3.3
Features	<ul style="list-style-type: none"> <li>- Non-toxic silicon Mask</li> <li>- Double cushion for secure fit</li> <li>- Anti-Fog Vision</li> </ul>	<ul style="list-style-type: none"> <li>- Non-toxic silicon Mask</li> <li>- Double cushion for secure fit</li> <li>- Anti-Fog Vision</li> </ul>	<ul style="list-style-type: none"> <li>- Non-toxic silicon Mask</li> <li>- Double cushion for secure fit</li> <li>- Anti-Fog Vision</li> </ul>	<ul style="list-style-type: none"> <li>- Non-toxic silicon Mask</li> </ul>	<ul style="list-style-type: none"> <li>- Non-toxic silicon Mask</li> <li>- Vest, Air Hose</li> <li>- Compressor</li> <li>- Anti-Fog Vision</li> </ul>
Application	For most common organic pesticides and agro-chemical fumigants, e.g . Pyrethrin and Methil Bromide	For most halogen, organic, ammonia and sulfurous acid gas, e.g. Meththyl Bromide, Sulfuryl Fluoride, Methyl Iodine and Phosphine gas (PH3)	For most halogen, organic, ammonia and sulfurous acid gas, e.g. Meththyl Bromide, Sulfuryl Fluoride, Methyl Iodine and Phosphine gas (PH3)	For organic compound in low concentration and dust of first grade	For most high concentrations toxic gases, e.g. Phosphine gas (PH3) and Carbon Monoxide (CO)

## COVERALL

<b>Material</b>	SMS
<b>Colour</b>	Blue
<b>Size</b>	Large
<b>Application</b>	Pest control, Cleaning etc.

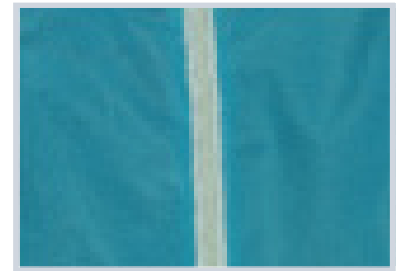

Resistant to punctures and tears. Vectorfog disposable coverall creates a barrier against chemical splashes in low concentrations. Thanks to its specially designed spunbonded-meltblown-spunbonded (SMS) three layer fabric, this coverall will give you ultimate protection without sacrificing mobility and comfort. Features include elasticated hood, wrists and ankles. Our coveralls conform to EN13892-1 and EN13034 standards.

## GOGGLES

<b>Type</b>	Safety Goggles
<b>Lens</b>	Anti-fog, Anti-scratch, Anti-UV
<b>Weight</b>	100g (0.035 oz.)
<b>Size</b>	Adjustable with headband



Vectorfog safety goggles offer the ultimate in comfort and eye protection against impact, dust, gases, UV rays and chemical splashes. Thanks to its curved design, ventilation system and anti-scratch/anti-fog coated polycarbonate lens, these lightweight goggles will provide the user with a superb distortion free field of view. With a fully adjustable elastic headband, these versatile goggles can also be worn in combination with a helmet. These goggles conform to EU CE EN166 standards.

## GLOVES

<b>Materials</b>	High quality nitrile
<b>Length (cm)</b>	33
<b>Length (inch)</b>	13
<b>Application</b>	Industrial, Housework etc.
<b>Feature</b>	Sun-proof, Anti-friction



Vectorfog chemical resistant nitrile gloves are made from 100% high-quality nitrile and provide excellent protection against most agricultural chemicals, solvents, acids and caustics. Resistant to punctures, abrasions and cuts, these reusable, sun-proof, anti-friction gloves are ergonomically moulded, improving comfort and fit. These gloves can be used for the home as well as for agricultural, pest-control, gardening and industrial applications.

# PEST CONTROL EQUIPMENT

## BAIT GUN DH1

<b>Capacity</b>	35 g (1.23 oz.)
<b>Materials</b>	PP
<b>Weight</b>	160 g (0.4 lb)
<b>Dimension (cm)</b>	18 x 14.5 x 3
<b>Dimension (inch)</b>	7.1 x 5.7 x 1.2



The VectorGel™ bait gun DH1 is a durable and easy to use precision applicator compatible with most standard 35 gram (1.23 oz.) gel bait cartridges used in pest control applications. Simply place the cartridge from Maxforce or Dupont and start applying immediately to eradicate your pest problem.

## BAIT GUN SET DH2

<b>Capacity</b>	70 g (2.5 oz.)
<b>Materials</b>	PP
<b>Weight</b>	640 g (1.4 lb)
<b>Dimension (cm)</b>	31 x 20 x 6.5
<b>Dimension (inch)</b>	12.2 x 7.9 x 2.6
<b>Contents</b>	Applicator, 3x Cartridges, Squeeze tool, 3x Tips



The VectorGel™ bait gun DH2 is a durable and easy to use precision applicator compatible with most standard 70 gram (2.5 oz.) gel bait cartridges used in pest control applications. This bait gun set is designed for people who are looking for a larger capacity applicator. This set comes an applicator, extra capacity cartridges, holder, squeeze tool and spare tips.

# COMPACT RAT BAIT BOX

## B100

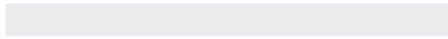

<b>Type of Pest</b>	Rat or similar sized rodents
<b>Material</b>	Polypropylene
<b>Dimension (cm)</b>	24 x 22 x 7
<b>Dimension (inch)</b>	9.5 x 8.7 x 2.8
<b>Colour</b>	Black



The Vectortrap secure rat bait box is a robust, easy to use, low-profile bait station. Equipped with child tamper resistant locks, this compact box includes a fixed tray for loose bait and a bar for securing bait blocks. A snap trap for this bait box is also available on request.

# MOUSE BAIT BOX

## B101

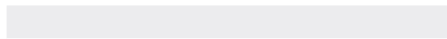

<b>Type of Pest</b>	Mouse or similar sized rodents
<b>Material</b>	Polypropylene
<b>Dimension (cm)</b>	10 x 13 x 4
<b>Dimension (inch)</b>	4 x 5.1 x 1.6
<b>Colour</b>	Black



The Vectortrap mouse box is a durable and practical mouse box. Equipped with a child tamper resistance lock and lid, this easy to service box has enough space for 1 large bait block or 2 smaller ones on either side. This bait box is ideal for indoor and outdoor mouse control.



# INSECT MONITOR

## B102

<b>Type of Pest</b>	Cockroach or similar sized crawling insects
<b>Material</b>	Polypropylene
<b>Dimension (cm)</b>	14.7 x 10.7 x 3
<b>Dimension (inch)</b>	5.8 x 4.2 x 1.2
<b>Colour</b>	Black



The new Vectortrap insect monitor is a reusable insect monitor for the detection and location of crawling insect pests. With a selection of different glue boards and lure options available for different target pests, this versatile low-profile plastic monitor can be positioned under beds or kitchen appliances for discreet monitoring. This monitor also has a large smooth lid ideal for placing a monitoring record sticker.

# TUBE RAT BAIT BOX

## B103

<b>Type of Pest</b>	Rat or similar sized rodents
<b>Material</b>	Polypropylene
<b>Dimension (cm)</b>	34 x 10 x 9.2
<b>Dimension (inch)</b>	13.4 x 4 x 3.6
<b>Colour</b>	Black



Designed in the shape of a drain pipe, the Vectortrap secure rat bait box is a robust and durable bait station. Equipped with child tamper resistance locks, this bait box also features ramped entrances allowing the bait to stay dry in water-prone areas. This bait station includes a fixed tray for loose bait and a bar for securing bait blocks.

# DUAL TECHNO BAIT BOX

## B105



<b>Type of Pest</b>	Rat or similar sized rodents
<b>Material</b>	Polypropylene
<b>Dimension (cm)</b>	24 x 19 x 7
<b>Dimension (inch)</b>	9.5 x 7.7 x 2.8
<b>Colour</b>	Black

This Dual Function Bait Box combines our bestselling compact bait station with a traditional snap trap. Depending on the type of control desired, the set includes rod made of galvanized steel for attaching poison cubes and a place inside to put the snap. This trap is made using high quality polypropylene, child tamper resistant locks and it's easy to use and clean.

# MULTIBOX RAT BAIT STATION

## B112



<b>Type of Pest</b>	Rat or similar sized rodents
<b>Material</b>	Polypropylene
<b>Dimension (cm)</b>	25.4 x 17.5 x 11.4
<b>Dimension (inch)</b>	10 x 7 x 4.5
<b>Colour</b>	Black

This Multibox Rat Bait Station is based on our popular Techno Bait Box but roomier. The set includes two rods made of galvanized steel for attaching poison cubes for maximum kill or enough space to put two full sized rat snap traps. You can also use one of each. This trap is made using high quality polypropylene, child tamper resistant locks, and it's easy to use and clean.

# DISC FOR INSECT BAIT

## B113

<b>Type of Pest</b>	Ants or similar sized crawling insects
<b>Material</b>	Polypropylene
<b>Dimension (cm)</b>	4 x 4 x 1.5
<b>Dimension (inch)</b>	1.6 x 1.6 x 0.6
<b>Colour</b>	Black



Designed to house insect poison (not included) securely, this easy to use, easy to clean bait disk can be fixed to walls, floors and small gaps where insects are frequent. This disk is great where you want to control an infestation but providing protection to pets and children.

# METAL SNAP RAT TRAP

## B106

<b>Type of Pest</b>	Rat or similar sized rodents
<b>Material</b>	Metal
<b>Dimension (cm)</b>	17.8 x 10 x 4
<b>Dimension (inch)</b>	7 x 4 x 1.6
<b>Colour</b>	Silver

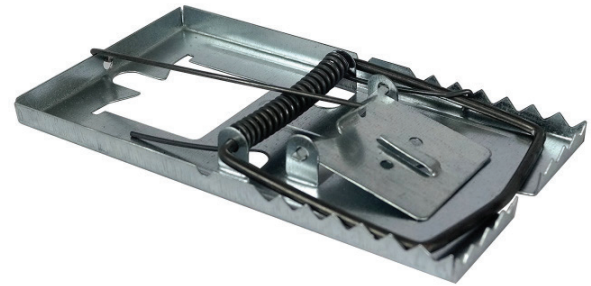

Made of galvanized steel, this robust and powerful trap is manufactured to stand the test of time, perfect for the discerning pest controller. Thanks to its paddle design, strong spring and serrated teeth this trap will ensure a quick and fast kill.

# PLASTIC RAT SNAP TRAP

## B107

<b>Type of Pest</b>	Rat or similar sized rodents
<b>Material</b>	Polypropylene
<b>Dimension (cm)</b>	14 x 7.5 x 5.5
<b>Dimension (inch)</b>	5.5 x 3 x 2.2
<b>Colour</b>	Black



This Rat snap is easy and safe use compared to traditional wooden traps. With a large bait cup, the trap allows you to bait the trap prior to setting it, enhancing safety.

# PLASTIC MOUSE SNAP TRAP

## B108

<b>Type of Pest</b>	Mouse or similar sized rodents
<b>Material</b>	Polypropylene
<b>Dimension (cm)</b>	10 x 6 x 4.5
<b>Dimension (inch)</b>	4 x 2.4 x 1.8
<b>Colour</b>	Black



This Mouse snap is easy and safe use compared to traditional wooden traps. With a large bait cup, the trap allows you to bait the trap prior to setting it, enhancing safety.

## METAL MOUSE CATCHER

### B109

<b>Type of Pest</b>	Mouse or similar sized rodents
<b>Material</b>	Metal
<b>Dimension (cm)</b>	48 x 9 x 9
<b>Dimension (inch)</b>	19 x 3.5 x 3.5
<b>Colour</b>	Silver



Made of galvanized steel for maximum resistance to rust and corrosion, the metal mouse catcher B-109 has been designed to trap up to two mice without killing them. Specifications include side breathing holes, two entrances, bait hooks and a top access panel.

## METAL MOUSE CATCHER

### B110

<b>Type of Pest</b>	Mouse or similar sized rodents
<b>Material</b>	Metal
<b>Dimension (cm)</b>	26 x 11.5 x 11
<b>Dimension (inch)</b>	10.2 x 4.5 x 4.3
<b>Colour</b>	Silver

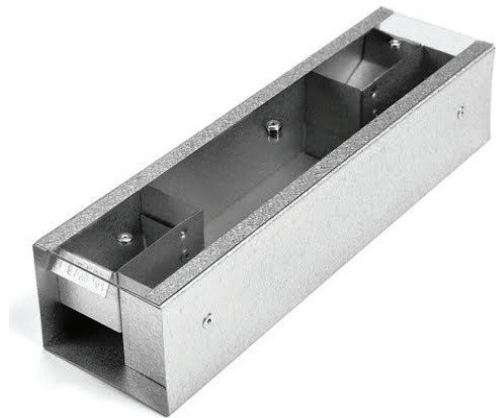

Made of galvanized steel for maximum resistance to rust and corrosion, the metal mouse catcher B-110 has been designed to trap up to two mice without killing them. Specifications include two entrances, bait area and a top access panel with view port.

## METAL RAT CATCHER

### B111

<b>Type of Pest</b>	Rat or similar sized rodents
<b>Material</b>	Metal
<b>Dimension (cm)</b>	48.3 x 9 x 9
<b>Dimension (inch)</b>	19 x 3.5 x 3.5
<b>Colour</b>	Silver



Made of galvanized steel for maximum resistance to rust and corrosion, the metal mouse catcher B-111 has been designed to trap up to two rats without killing them. Specifications include side breathing holes, two entrances, bait hooks and a top access panel with view port.

## LIVE ANIMAL CAGE TRAP

### B115

<b>Type of Pest</b>	Rodents includes chipmunks, mice, rats, etc.
<b>Material</b>	Metal
<b>Dimension (cm)</b>	51 x 20.3 x 20.3
<b>Dimension (inch)</b>	20 x 8 x 8
<b>Colour</b>	Silver



Made of galvanized steel for maximum resistance to rust and corrosion, the live animal cage trap B-115 has been designed to trap chipmunks, red squirrels, ground squirrels, flying squirrels, rats & other similar-size nuisance animals. Specifications include a spring loaded door, sensitive trigger and a handle to limit contact with the animal.

## LIVE ANIMAL CAGE TRAP

### B116

<b>Type of Pest</b>	Rodents includes chipmunks, mice, rats, etc.
<b>Material</b>	Metal
<b>Dimension (cm)</b>	86.3 x 30.5 x 20.3
<b>Dimension (inch)</b>	34 x 12 x 8
<b>Colour</b>	Silver

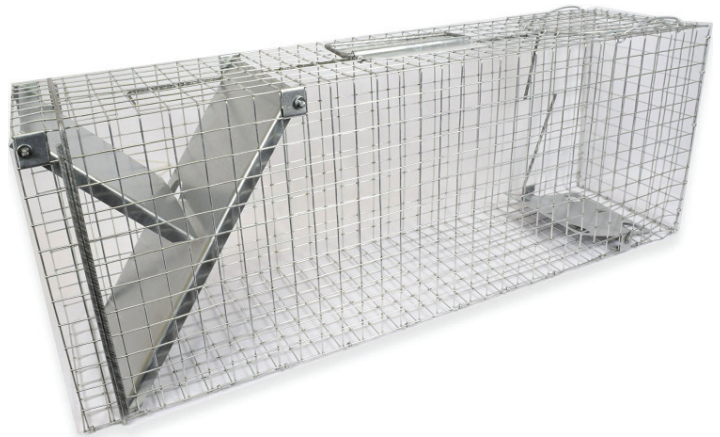

Made of galvanized steel for maximum resistance to rust and corrosion, the live animal cage trap B-116 has been designed to trap larger animals including stray cats, rabbits, skunks, Minks, large squirrels & other similar-size nuisance animals. Specifications include a spring loaded door, sensitive trigger and a handle to limit Contact with the animal.

## LIVE ANIMAL CAGE TRAP

### B117

<b>Type of Pest</b>	Rodents includes chipmunks, mice, rats, etc.
<b>Material</b>	Metal
<b>Dimension (cm)</b>	50 x 20 x 17
<b>Dimension (inch)</b>	19.7 x 7.9 x 6.7
<b>Colour</b>	Silver

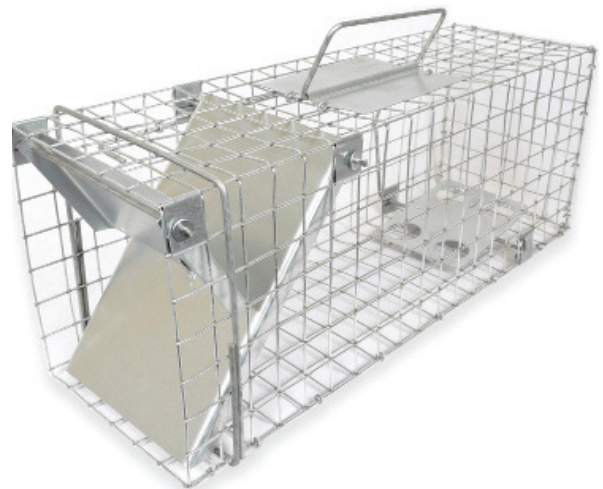

Made of galvanized steel for maximum resistance to rust and corrosion, the live animal cage trap has been designed to trap chipmunks, red squirrels, ground squirrels, flying squirrels, rats & other similar-size nuisance animals. Specifications include a spring loaded door, sensitive trigger and a handle to limit contact with the animal.

# BIRD REPELLENT

## BG250

Type	Bird repellent gel
Ingredients	Polypropylene
Box Dimensions (cm)	14.7 x 10.7 x 3
Box Dimensions (inch)	x x x
Contents included	1 unit with 15 dishes and 1 nozzle



## Natural, High Efficient Vectorfog Bird Gel

Vectorfog Bird Repellent is a new, highly efficient long lasting bird repellent gel. Proven to deter many bird including Pigeons and Sea Gulls without harming them. Vectorfog Bird Repellent comes in a 250gr tube for use with a caulking gun.

## How does our bird repellent work?

This completely natural, non-toxic 4in1 gel, has been specially formulated to work on four of the animal senses: Sight, Smell, Taste and Tough.

- **Sight:** This new high-tech gel emits strong Ultra Violet Rays which startles the birds when they try to approach it. A feeling of warning/danger keeps them away.
- **Taste:** Made with a special blend of oils this gel has a disgusting taste to birds. Once eaten, it causes the birds to leave immediately and learn over time never to return to the same spot.
- **Smell:** Made with natural herbal extracts. VectorFree™ Bird Gel, has a specially formulated smell which creates an unfamiliar and distressing environment for the birds to perch on. With olfactory enhancers, this smell repellent makes it one of the most efficient in the market.
- **Touch:** Thanks to its sticky consistency, this gel prevents birds landing because of their "tacky" feel. They learn over time never to return to the same spot.

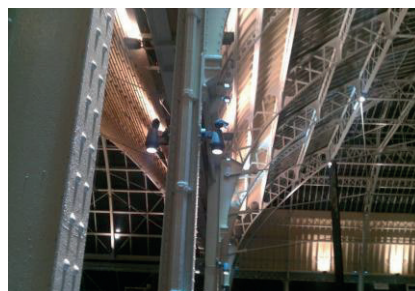
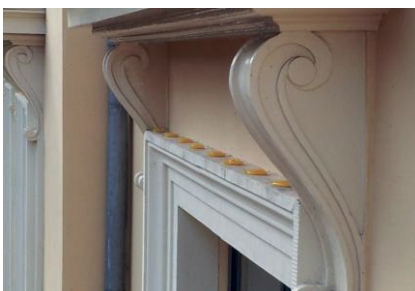

# HISTORY



## 1991

Founded in South Korea by Gyu Jo Yeom, an engineer in molecular technology.

## 1995

The company becomes OEM for Samsung Electronics.

## 2008

The company launches its first ULV cold fogger.

## 2009

A global sales office and European distribution centre is established in the United Kingdom.

## 2011

Gains key supply contracts from international Organisations including the UNDP (United Nation Development Program) and FAO (Food and Agriculture Organization).

## 2012

Vectorfog launches a global market penetration initiative on its pest control equipment line. By the end of 2012, exports increase to over 70 countries and over 30 countries worldwide are represented.

## 2013

Vectorfog opens a new global logistics centre in Jangsung, South Korea and adds a new line of fly traps and safety equipment lines are introduced to its range.

## 2015

Vectorfog opens a new sales office and logistics centre in Miami, sales office and logistics centre in Miami, Florida, USA





# **VECTOR FOG™**

EXPERTS IN FOGGING TECHNOLOGY™

## **VECTORFOG**

Miami, FL, USA, TEL: +1 305 479 230 1  
Basingstoke, U.K., TEL: +44 (0)20 3808 5797  
Jang Seong, S Korea, TEL: +82 (0)70 4694 2490

[info@vectorfog.com](mailto:info@vectorfog.com)  
[www.vectorfog.com](http://www.vectorfog.com)