

## Camera Body Temperature

If your camera is used for prolonged periods, the camera body may become warm. Please be aware of this and take care when operating the camera for an extended period.

## About the LCD Monitor

The LCD monitor is produced with extremely high-precision manufacturing techniques. More than 99.99% of the pixels operate to specification. Less than 0.01% of the pixels may occasionally misfire or appear as red or black dots. This has no effect on the recorded image and does not constitute a malfunction.

## Video Format

Please set the camera's video signal format to the one used in your region before using it with a TV monitor (p. 175).

## Language Setting

Please see page 29 to change the language setting. Please read through the "Read This First" section (p. 6) before using your camera.

### Disclaimer







- While every effort has been made to ensure that the information contained in this guide is accurate and complete, no liability can be accepted for any errors or omissions.
- Canon reserves the right to change the specifications of the hardware and software described herein at any time without prior notice.
- No part of this guide may be reproduced, transmitted, transcribed, stored in a retrieval system, or translated into any language in any form, by any means, without the prior written permission of Canon.
- Canon makes no warranties for damages resulting from corrupted or lost data due to a mistaken operation or malfunction of the camera, the software, the CompactFlash™ cards (CF cards), personal computers, peripheral devices, or use of non-Canon CF cards.

### Trademark Acknowledgments

- Canon and PowerShot and Bubble Jet are trademarks of Canon, Inc.
- CompactFlash is a trademark of SanDisk Corporation.
- iBook and iMac are trademarks of Apple Computer, Inc.
- Macintosh, PowerBook, Power Macintosh and QuickTime are trademarks of Apple Computer, Inc, registered in the United States and other countries.
- Microsoft, Windows, and Windows NT are either registered trademarks or trademarks of Microsoft Corporation in the United States and/or other countries.
- Other names and products not mentioned above may be registered trademarks or trademarks of their respective companies.

# About this Camera User Guide

## Symbols Used

Icons under title bars show the operations mode. As in the example below, the mode dial should be set to **AUTO**, **P**, **Tv**, **Av**, **M**, **C1**, **C2**, , , , ,  or .

### Using the Flash

Available in the following modes.



: This mark denotes issues that may affect the camera's operation.



: This mark denotes additional topics that complement the basic operating procedures.

## Question? Look here first.

- What settings are available under each function?
- Will my settings remain in effect even after I've turned the camera off?

**Functions Available in Each Shooting Mode (p. 212)**

- What functions are available through the menus?

**FUNC. Menu (p. 165)**

**Rec. Menu (p. 167)**

**Play Menu (p. 170)**

**Set up Menu (p. 172)**

**My Camera Menu (p. 176)**

- What do the icons listed in the *Camera User Guide* mean?

**Information Displayed on the LCD Monitor (p. 37)**

**Menu Settings and Default Settings (p. 52)**

The above sections are shaded on the right edges to make them easy to find.

**Quick Start**

**Preparing the Camera,  
Basic Functions**

**Shooting**

**Playback, Erasing**

**Print Settings,  
Transferring**

**Connecting**







**My Camera Settings**



**Menu and Message Lists**

**Appendix**

# Table of Contents

 : These pages include summaries of the functions or operation of the camera.



<b>Read This First</b>	<b>6</b>
<b>Quick Start</b>	<b>14</b>
<b>Components Guide</b>	<b>16</b>
<b>Preparing the Camera</b>	<b>20</b>
Installing the Batteries .....	20
Installing a CF Card .....	24
Setting the Date/Time .....	26
Setting the Language .....	29
<b>Basic Functions</b>	<b>31</b>
Turning the Power On .....	31
Switching between Shooting and Playback .....	33
Using the LCD Monitor .....	34
Using the Viewfinder to Shoot .....	42
Using the Zoom .....	43
Pressing the Shutter Button .....	44
<b>Selecting Menus and Settings</b> .....	<b>47</b>
<b>Shooting-Letting the Camera Select Settings</b>	<b>56</b>
 Auto Mode .....	56
Reviewing an Image Right After Shooting .....	58
Changing the Resolution and Compression .....	60
 Using the Flash .....	64
 Portrait Mode .....	67
 Landscape Mode .....	68
 Night Scene Mode .....	69
 Fast Shutter .....	70
 Slow Shutter .....	71

 Panoramic Images (Stitch Assist Mode) .....	72
 Movie Mode .....	76
 Macro Mode .....	78
Self-Timer .....	80
Digital Zoom .....	82
Continuous Shooting .....	84

## **Shooting-Selecting Particular Effects 86**

<b>P</b> Program AE .....	86
<b>Tv</b> Setting the Shutter Speed .....	88
<b>Av</b> Setting the Aperture .....	91
<b>M</b> Manually Setting the Shutter Speed and Aperture .....	94
Switching Between Autofocus Modes .....	96
Switching Between Light Metering Modes .....	97
Adjusting the Exposure .....	99
Adjusting the Tone (White Balance) .....	102
Changing the Photo Effect .....	107
Changing the ISO Speed .....	109
Adjusting the Flash Output .....	111
Shooting Problem Subjects for the Autofocus .....	112
<b>C1 C2</b> Saving Custom Settings .....	116
Setting the Auto Rotate Function .....	118
Resetting the File Numbers .....	120

## **Playback 122**

Displaying Images Individually .....	122
 Magnifying Images .....	123
 Viewing Images in Sets of Nine (Index Playback) .....	124
Jumping Between Images .....	125
Viewing Movies .....	126
Editing Movies .....	128
Rotating Images in the Display .....	131
Attaching Sound Memos to Images .....	132
Auto Play .....	134
Protecting Images .....	135

<b>Erasing</b>	<b>136</b>
Erasing Images Individually .....	136
Erasing All Images .....	137
Formatting a CF Card .....	138
<b>Print Settings</b>	<b>140</b>
About Printing .....	140
Print Settings (DPOF Print Settings) .....	142
<b>Image Transfer Settings (DPOF Transfer Order)</b>	<b>148</b>
Selecting Images for Transferring .....	148
<b>Downloading Images to a Computer</b>	<b>150</b>
Connecting the Camera to a Computer	
Via the USB Cable .....	150
Downloading Directly from a CF Card .....	154
<b>Viewing Images on a TV Set</b>	<b>155</b>
<b>Customizing the Camera (My Camera Settings)</b>	<b>157</b>
Changing My Camera Settings .....	157
Registering My Camera Settings .....	160
<b>List of Menu Options and Messages</b>	<b>165</b>
<b>FUNC. Menu</b> .....	<b>165</b>
<b>Rec. Menu</b> .....	<b>167</b>
<b>Play Menu</b> .....	<b>170</b>
<b>Set up Menu</b> .....	<b>172</b>
<b>My Camera Menu</b> .....	<b>176</b>
Resetting the Settings to Default .....	178
List of Messages .....	180
<b>Appendix</b>	<b>182</b>
Using the Battery Kits (Sold Separately) .....	182
Using the Lenses and Lens Adapter (Sold Separately) .....	186

Camera Care and Maintenance ..... 191

**Troubleshooting 192**

**Specifications 199**

**Index 208**

**Functions Available in Each Shooting Mode 212**

**COPY**

# Read This First

## Please Read

### Test Shots

Before you try to photograph important subjects, we highly recommend that you shoot several trial images to confirm that the camera is operating and being operated correctly. Please note that Canon, its subsidiaries and affiliates, and its distributors are not liable for any consequential damages arising from any malfunction of a camera or accessory, including CompactFlash™ cards, that results in the failure of an image to be recorded or to be recorded in a format that is machine readable.

### Warning Against Copyright Infringement

Please note that Canon digital cameras are intended for personal use and must be used in a manner that respects international and domestic copyright laws and regulations. Please be advised that in certain cases the copying of images from performances, exhibitions, or commercial properties by means of a camera or other device may contravene copyright or other legal rights even if the image was recorded for personal use.

### Warranty Limitations

This camera's warranty is only effective in the country of sale. If a problem arises while the camera is in use abroad, please convey it back to the country of sale before proceeding with a warranty claim to a Canon Customer Support Help Desk.

**For Canon Customer Support contacts, please see the Canon Limited Warranty supplied with your camera.**



## Safety Precautions

- Before using the camera, please ensure that you have read and understood the safety precautions described below. Always ensure that the camera is operated correctly.
- The safety precautions noted on the following pages are intended to instruct you in the safe and correct operation of the camera and its accessories to prevent injuries or damage to yourself, other persons and equipment.
- In the next few pages, the term “equipment” refers primarily to the camera, its power supply accessories and the separately sold compact power adapter.

COPY

## WARNINGS

- **Do not aim the camera directly into the sun or at other intense light sources which could damage your eyesight.**
- **Do not trigger the flash in close proximity to human or animal eyes.** Exposure to the intense light produced by the flash may damage eyesight. In particular, remain at least one meter (39 inches) away from infants when using the flash.
- **Store this equipment out of the reach of children and infants.** Accidental damage to the camera or batteries by a child could result in serious injury. In addition, placement of the strap around a child's neck could result in asphyxiation.
- **Do not attempt to disassemble or alter any part of the equipment that is not expressly described in this guide.** Disassembly or alteration may result in high-voltage electrical shock. Internal inspections, alterations and repairs should be conducted by qualified service personnel authorized by your camera distributor or a Canon Customer Support Help Desk.
- **To avoid the risk of high-voltage electrical shock, do not touch the flash portion of the camera if it has been damaged.** Similarly, never touch internal portions of the equipment that become exposed as a result of damage. There is a risk of high-voltage electrical shock. Please take the first opportunity to consult your camera distributor or a Canon Customer Support Help Desk.
- **Stop operating the equipment immediately if it emits smoke or noxious fumes. Failure to do so may result in fire or electrical shock.** Immediately turn the camera's power off, remove the camera batteries and unplug the power cord from the power outlet. Confirm that smoke or fume emissions have ceased. Please consult your camera distributor or the closest Canon Customer Support Help Desk.

- 
- **Stop operating the equipment if it is dropped or the casing is damaged.** Failure to do so may result in fire or electrical shock. **Immediately turn the camera's power off, remove the camera batteries or unplug the power cord from the power outlet.** Please consult your camera distributor or the closest Canon Customer Support Help Desk.
- 
- **Do not allow the equipment to come into contact with, or become immersed in, water or other liquids.** Do not allow liquids to enter the interior. The camera has not been waterproofed. If the exterior comes into contact with liquids or salt air, wipe it dry with a soft, absorbent cloth. In the event that water or other foreign substances enter the interior, immediately turn the camera's power off and remove the camera batteries or unplug the power cord from the electrical outlet. Continued use of the equipment may result in fire or electrical shock. Please consult your camera distributor or the closest Canon Customer Support Help Desk.
- 
- **Do not use substances containing alcohol, benzene, thinners or other flammable substances to clean or maintain the equipment.** The use of these substances may lead to fire.
- 
- **Remove the power cord on a regular periodic basis and wipe away the dust and dirt that collects on the plug, the exterior of the electrical outlet and the surrounding area.** In dusty, humid or greasy environments, the dust that collects around the plug over long periods of time may become saturated with humidity and short-circuit, leading to fire.
- 
- **Do not cut, damage, alter or place heavy items on the power adapter cord.** Any of these actions may cause an electrical short circuit, which may lead to fire or electrical shock.
- 
- **Do not handle the power cord if your hands are wet.** Handling it with wet hands may lead to electrical shock. When unplugging the cord, ensure that you hold the solid portion of the plug. Pulling on the flexible portion of the cord may damage or expose the wire and insulation, creating the potential for fires or electrical shocks.
-

- 
- **Use of power sources not expressly recommended for this equipment may lead to overheating, distortion of the equipment, fire, electrical shock or other hazards.** Use only the recommended power accessories.
- 
- **Do not place the batteries near a heat source or expose them to direct flame or heat.** Neither should you immerse them in water. Such exposure may damage the batteries and lead to the leakage of corrosive liquids, fire, electrical shock, explosion or serious injury.
- 
- **Do not attempt to disassemble, alter or apply heat to the batteries.** There is serious risk of injury due to an explosion. Immediately flush with water any area of the body, including the eyes and mouth, or clothing, that comes into contact with the inner contents of a battery. If the eyes or mouth contact these substances, immediately flush with water and seek medical assistance.
- 
- **Avoid dropping or subjecting the batteries to severe impacts that could damage the casings.** It could lead to leakage and injury.
- 
- **Do not short-circuit the battery terminals with metallic objects, such as key holders.** It could lead to overheating, burns and other injuries.
- 
- **Before you discard a battery, cover the terminals with tape or other insulators to prevent direct contact with other objects.** Contact with the metallic components of other materials in waste containers may lead to fire or explosions. Discard the batteries in specialized waste facilities if available in your area.
- 
- **Use of batteries not expressly recommended for this equipment may cause explosions or leaks, resulting in fire, injury and damage to the surroundings.** Use only recommended batteries and accessories.
- 
- **If using AA-size NiMH batteries, use only Canon AA-size NiMH batteries and charger recommended for use with these batteries.** Use of another charger may cause batteries to overheat or deform, posing risk of fire or electric shock.
-

- 
- **Disconnect the battery charger or the compact power adapter from both the camera and power outlet after recharging and when the camera is not in use to avoid fires and other hazards.**

---

  - **The camera terminal of the battery charger cord and the compact power cord is designed for exclusive use with your camera.** Do not use it with other products or batteries. There is a risk of fire and other hazards.

---

  - **Exercise due caution when screwing on the separately sold wide converter, tele-converter, close-up lens and conversion lens adapter.** If they loosen, fall off and shatter, the glass shards may cause an injury. Never aim the lenses at the sun or strong light sources. There is a risk of damage to eyesight.
- 

## CAUTIONS

- 
- **Avoid using, placing or storing the equipment in places subject to strong sunlight or high temperatures, such as the dashboard or trunk (boot) of a car.** Exposure to intense sunlight and heat may cause the batteries to leak, overheat or explode, resulting in fire, burns or other injuries. High temperatures may also cause deformation of the casing. Ensure that there is good ventilation when using the compact power adapter to charge the battery pack or power the camera.

---

  - **Do not store the equipment in humid or dusty areas.** Storage in such areas could lead to fire, electrical shock or other damage.

---

  - **Be careful not to bang the camera or subject it to strong impacts or shocks that could lead to injury or damage the equipment when wearing or holding it by the strap.**

---

  - **Be careful not to cover the flash with your fingers or clothing when shooting.** The flash may be damaged and emit smoke or noise. In addition, do not touch the surface of the flash after taking several pictures in rapid succession. Either action could result in burns.
-

- 
- **Do not operate the flash with dirt, dust or other items stuck to its lens.** The resulting heat build-up could damage the flash.
  - **If your camera is used for prolonged periods, the camera body may become warm.** Please take care when operating the camera for an extended period as your hands may experience a burning sensation.
- 

COPY

## Preventing Malfunctions

### **Avoid Strong Magnetic Fields**

Never place the camera in close proximity to electric motors or other equipment generating strong electromagnetic fields. Exposure to strong magnetic fields may cause malfunctions or corrupt image data.

### **Avoid Condensation Related Problems**

Moving the equipment rapidly between hot and cold temperatures may cause condensation (water droplets) to form on its external and internal surfaces.

You can avoid this by placing the equipment in an airtight, resealable plastic bag and letting it adjust to temperature changes slowly before removing it from the bag.

### **If Condensation Forms Inside the Camera**

Stop using the camera immediately if you detect condensation. Continued use may damage the equipment. Remove the CF card and batteries or power cord (if connected) from the camera and wait until the moisture evaporates completely before resuming use.

### **Extended Storage**

When not using the camera for extended periods of time, remove the batteries from the camera or battery charger and store the equipment in a safe place. Storing the camera for extended periods with batteries installed will run down the batteries and may damage the camera.

However, the date, time and other camera settings may reset to default settings if the batteries have been removed for more than three weeks.

# Quick Start

## 1 Install the batteries (p. 20).

Slide the battery cover lock, then open the cover and insert the batteries.

- For important information about batteries, see *Proper Battery Handling* (p. 21).

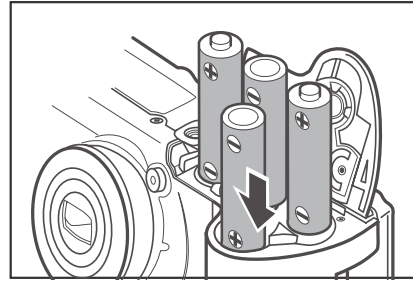

## 2 Install the CF card (p. 24).

Open the CF card slot cover and insert a CF card.

- Push the CF card all the way into the slot, so that the CF card eject button pops all the way out.

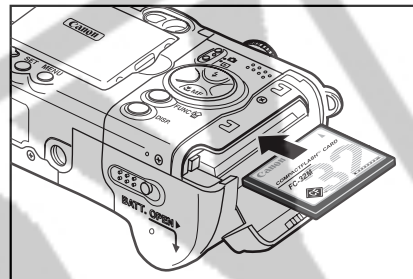

## 3 Open the LCD monitor (p. 34) and press the ON/OFF button to turn the camera on (p. 31).

Hold the ON/OFF button down until the power indicator next to the ON/OFF button lights green.

- If the LCD monitor displays the Date/Time menu, set the date and time (p. 26).
- For information about how to change the language, see *Setting the Language* (p. 29).

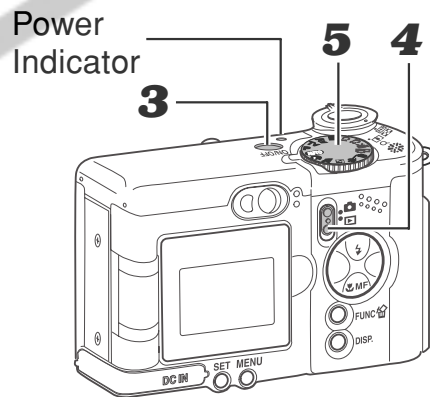

## 4 Slide the mode switch to (Shooting) (p. 33).



**5** Turn the mode dial to **AUTO** (p. 56).

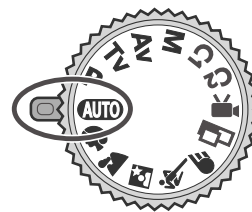

**6** Focus (p. 44).

Aim the camera at the subject, and lightly press and hold the shutter button halfway down. The camera beeps twice when the focus is set.

**7** Shoot (p. 45).

Press the shutter button all the way. You will hear the sound of the shutter close when the shot is complete.

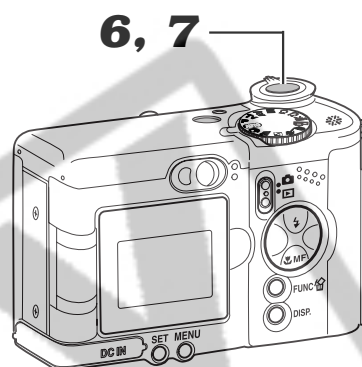

**8** View the recorded image.

The recorded image displays on the LCD monitor for approximately 2 seconds (p. 58).

For information about how to view other images that you have already taken, see *Playback* (p. 122).



#### To Immediately Erase the Displayed Image

- 1** Press the  button while the image is displayed.
- 2** Confirm that [Erase] is selected and press the **SET** button.



# Components Guide

Zoom Lever (p. 43, 82, 123, 124, 125)

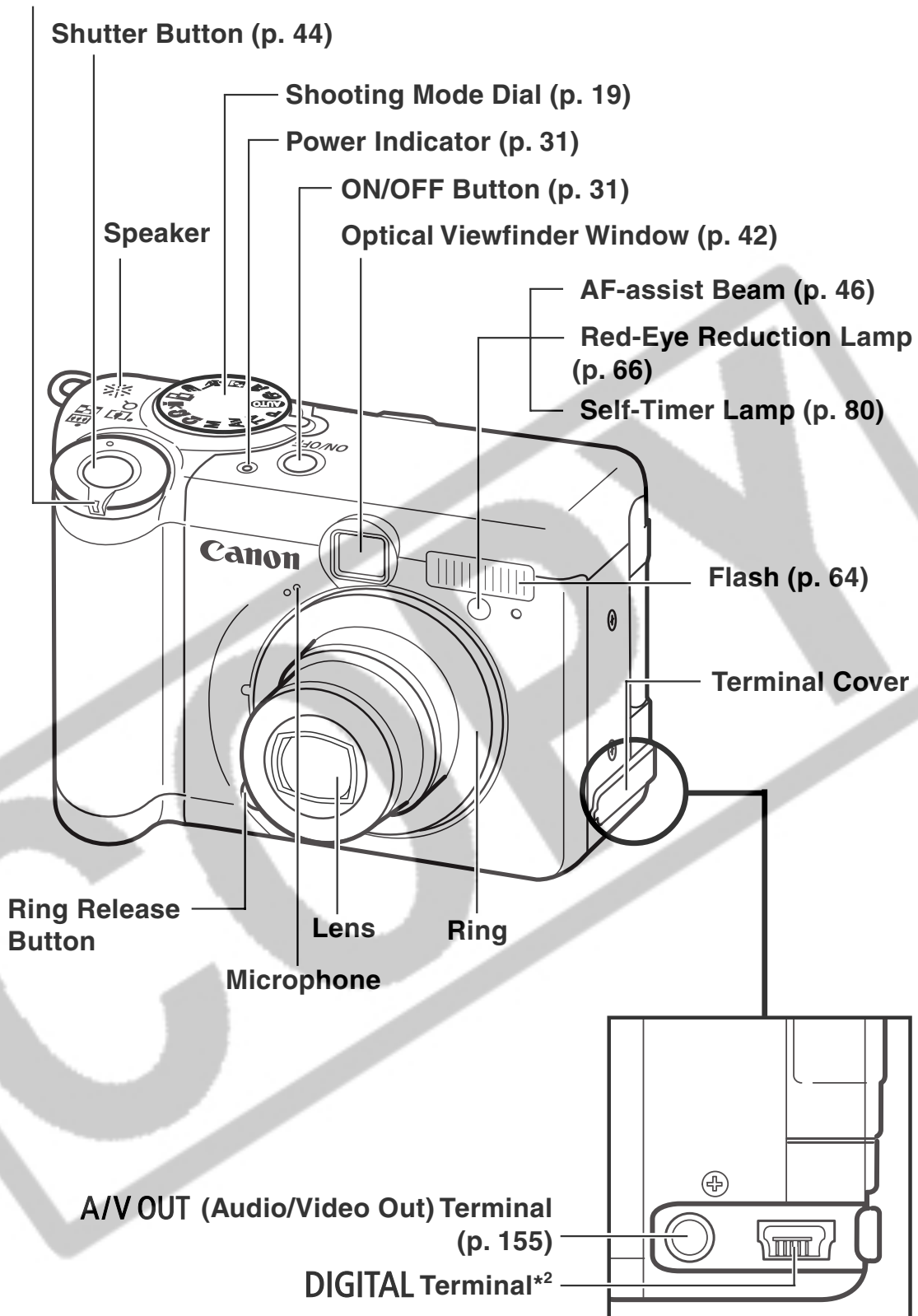

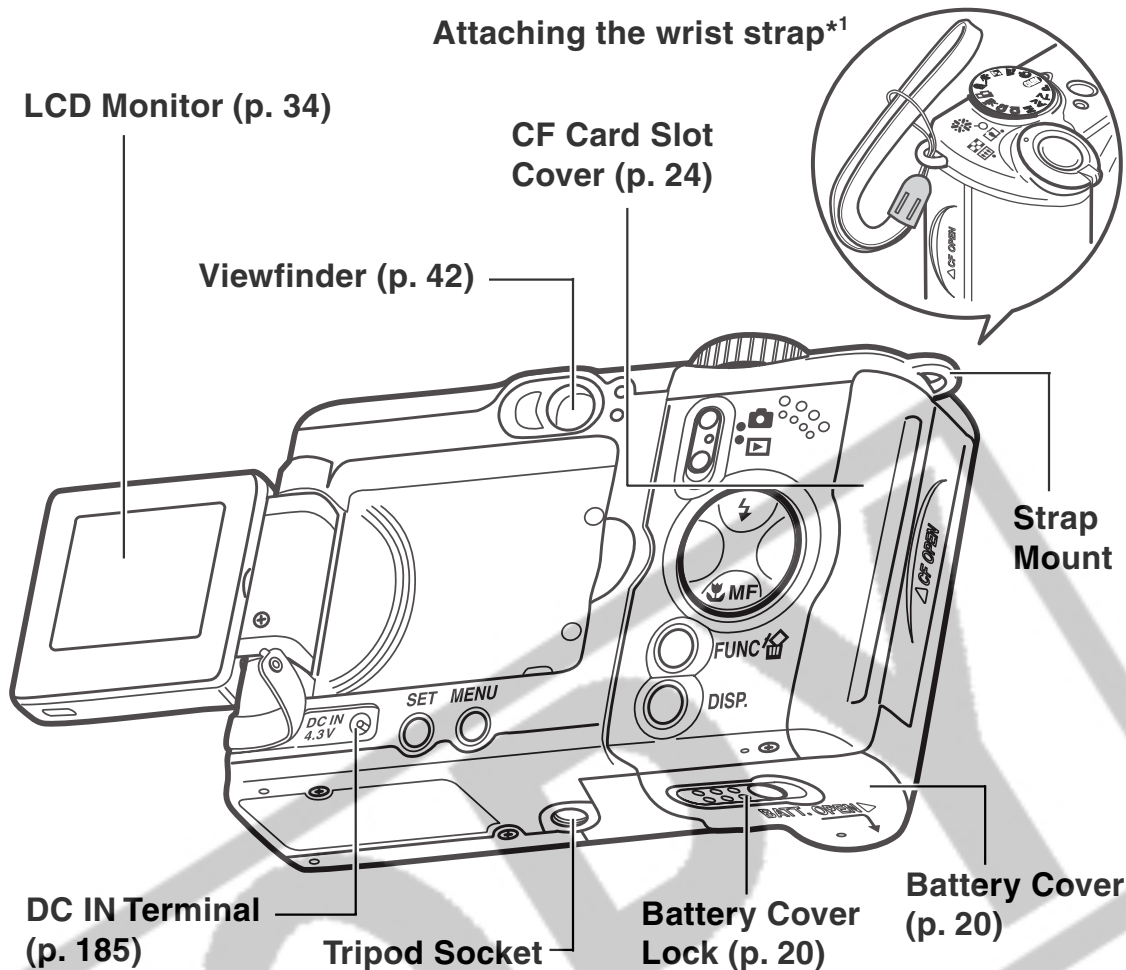

### Attaching the wrist strap\*1

\*1 Be careful not to wave the camera about or catch it on other items when dangling it from the wrist strap.

\*2 To connect the camera to a computer or printer, use one of the following cables.

- **Computer:** USB interface Cable IFC-300PCU (supplied with the camera)
- **Direct Print Compatible Printers (Sold Separately)**
  - CP Printers  
USB Interface Cable IFC-300PCU (supplied with the camera) or the Direct Interface Cable DIF-100 (supplied with the printer).
  - BJ Printers
    - *Canon Direct Print* Compatible Printers:  
Please refer to your Bubble Jet printer user guide.
    - *PictBridge* Compliant Printers:  
USB Interface Cable IFC-300PCU (supplied with the camera)
  - *PictBridge* Compliant Non-Canon Printers:  
USB Interface Cable IFC-300PCU (supplied with the camera)

Please refer to the *System Map* or the *Direct Print User Guide* supplied with the camera for direct print compatible printer information.

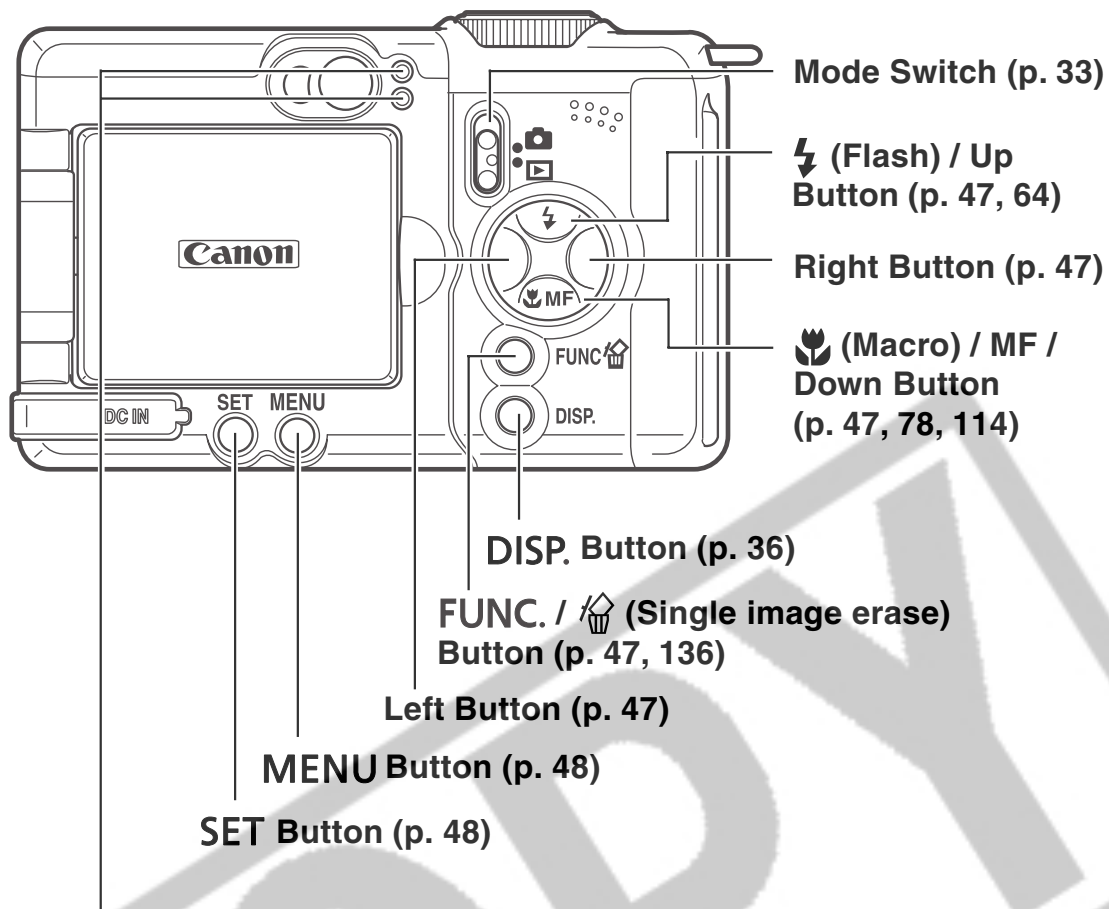

## Indicators

The indicators light or blink when the ON/OFF button or the shutter button is pressed.

### Upper Indicator

Green:	Ready to shoot
Blinking Green:	Recording to CF card / Reading CF card / Erasing from CF card / Transmitting data (during a computer connection) / Low battery
Orange:	Ready to shoot (flash on)
Blinking Orange:	Ready to shoot (camera shake warning)

### Lower Indicator

Yellow:	Macro mode / Manual focus mode
Blinking Yellow:	Focusing difficulty (although you can press the shutter button, try using focus lock (p. 112))

## Shooting Mode Dial

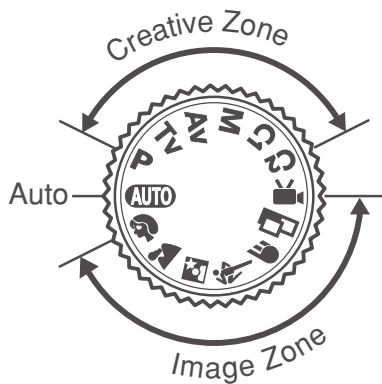

Use the shooting mode dial to select a shooting mode.

- **AUTO : Auto (p. 56)**

The camera automatically selects settings.

- **Image Zone**

The camera automatically selects settings according to the image composition type.

-  : Portrait (p. 67)
-  : Landscape (p. 68)
-  : Night Scene (p. 69)
-  : Fast Shutter Speed (p. 70)
-  : Slow Shutter Speed (p. 71)
-  : Stitch Assist (p. 72)
-  : Movie (p. 76)

- **Creative Zone**

The user selects exposure, aperture or other settings to achieve special effects.

- **P** : Program AE (p. 86)
- **Tv** : Shutter-priority AE (p. 88)
- **Av** : Aperture-priority AE (p. 91)
- **M** : Manual Exposure (p. 94)
- **C1** : Custom1 (p. 116)
- **C2** : Custom2 (p. 116)

# Preparing the Camera

## Installing the Batteries

The camera uses four AA-size alkaline batteries supplied with the camera. You may also use separately sold nickel metal hydride (NiMH) batteries.

- 1** Be sure that the camera power is off.
- 2** Slide the battery cover lock in the direction of the arrow, and push the battery cover slightly forward. Then open the cover.

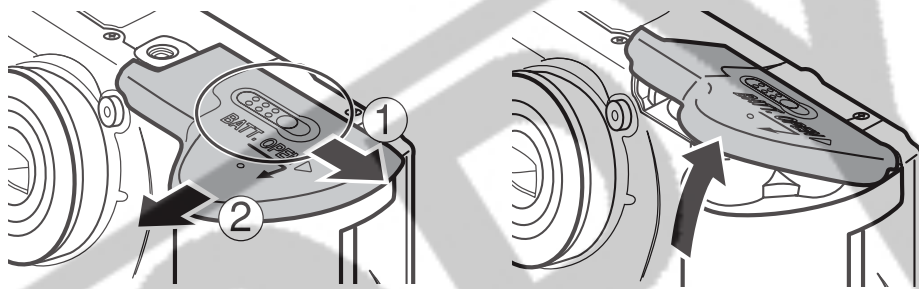

- 3** Insert the batteries as shown.

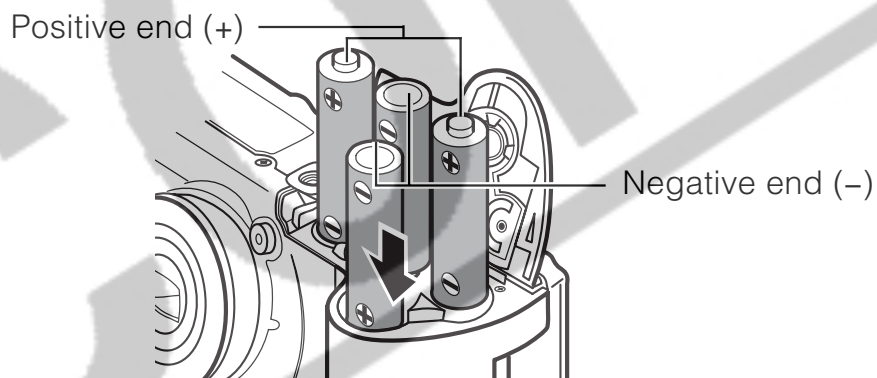

- 4** Close the battery cover.

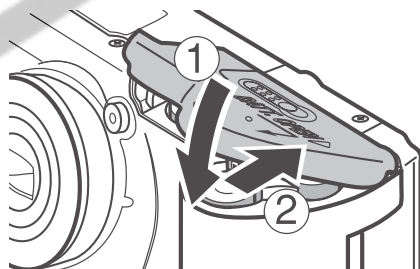



When the indicator next to the viewfinder blinks green, do not turn off the power or open the battery cover. The camera is writing, reading, erasing or transmitting an image to or from the CF card.



- We recommend that you use the separately sold AC Adapter Kit ACK600 to power the camera during long usage sessions (p. 184).
- The separately sold battery charger kit lets you use rechargeable NiMH batteries to power the camera (p. 182).
- For important information, see *Battery Performance* (p. 202).
- For information about the Battery and Charger Kit and AA-size rechargeable NiMH batteries, see the *System Map* (separate from this guide).

## Proper Battery Handling

- Use AA-size alkaline or Canon AA-size NiMH batteries (sold separately) only. For information on handling the AA-size rechargeable NiMH batteries, see *Using Rechargeable Batteries* (p. 182).
- Never use manganese or lithium batteries, as these battery types may overheat in the camera.
- Since the performance of alkaline batteries may differ according to brand, the operating time of the batteries you purchase may not be as long as the batteries that came with the camera.
- Camera operating time may shorten at low temperatures when alkaline batteries are used. Also due to their specifications, alkaline batteries may expire faster than NiMH batteries. If you are using the camera in cold areas or for a long time, we recommend using Canon AA-size NiMH Battery Kit (a four-piece set).
- While it is possible to use AA-size nickel-cadmium batteries, performance is unreliable and their use is not recommended.
- **Never mix unused and partially used batteries. Always load four fresh (or fully recharged) batteries at the same time.**



- **Be careful to load the batteries with their positive (+) and negative (-) ends in the right direction.**
- **Never mix batteries of different types or from different manufacturers. All four batteries should be identical.**
- Before inserting the batteries, wipe the battery terminals well with a dry cloth. Oil from one's skin or other dirt may cause a considerable reduction in the number of recordable images or reduced usage time.
- Battery performance deteriorates at low temperatures (especially with alkaline batteries). If you are using the camera in cold areas and batteries are running down faster than they should, you may be able to restore performance by placing batteries in an inner pocket to warm them up prior to use. But be careful that you don't put the batteries into a pocket together with a metal key chain or other metallic objects, as these objects may cause batteries to short-circuit.
- If you do not plan to use the camera for a long time, remove the batteries from the camera and store them in a safe place. Batteries may leak and damage the camera if left installed during prolonged periods of non-use. Please note that the date, time and other camera settings may reset to their default settings if the batteries have been removed for more than three weeks.

 **WARNING**

Never use damaged batteries or batteries whose outer seal is completely or partially missing or peeled off, as there is risk that such batteries may leak, overheat, or burst. Always check the seals on store-bought batteries before loading them, as some batteries may come with defective seals. Do not use batteries with defective seals.



## Never use batteries that look like this.



Batteries with all or part of the seal (electrical insulation sheath) peeled off.

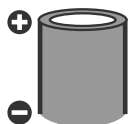

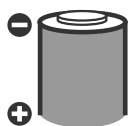

The positive electrode (plus terminal) is flat.



The negative terminal is correctly formed (protruding from the metal base), but the seal does not extend up over the edge of the metal base.

## Battery Status Indications

The indicators blink as explained below, and the LCD monitor displays an icon or message to let you know when batteries are low or depleted.

Power indicator blinks green.	Batteries are beginning to run low. Replace or recharge the batteries if you wish to continue using the camera.
	If the LCD monitor is off, this icon will appear when you press any of the following buttons: <b>DISP.</b>  or  / <b>MF.</b>
Change the batteries	Batteries are fully depleted and the camera can no longer operate. You should replace the batteries immediately.

## Installing a CF Card

- 1** Be sure that the camera is turned off.
- 2** Slide the CF card slot cover in the direction of the arrow, and open it.

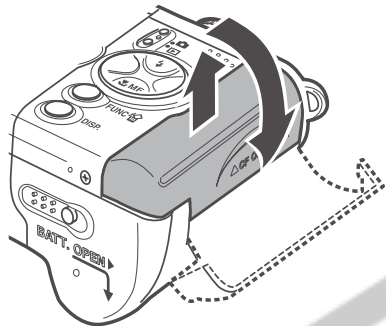

- 3** Insert the CF card with the label facing out and the arrow pointing in.

- Insert the CF card all the way into the slot, so that the CF card eject button pops all the way out.

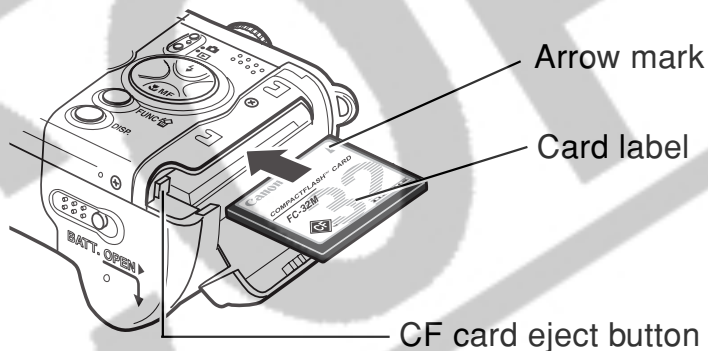

- To remove the CF card, press the CF card eject button.

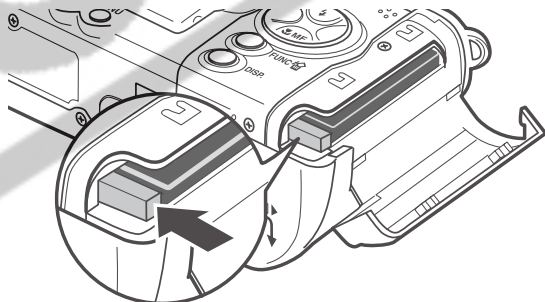

## 4 Close the CF card slot cover securely.



- When the indicator on the left side of the viewfinder blinks green, the camera is writing, reading, erasing or transmitting an image to or from the card. Do not perform the following, for image data may be lost or corrupted:
  - Do not shake the camera.
  - Do not turn off the power or open the CF card slot cover.
- Be aware that use of CF cards whose contents have been edited with another camera or with another company's software may cause the camera to operate incorrectly.
- You are recommended to use CF cards that have been formatted in your camera (p. 138). The card supplied with the camera may be used without further formatting.



For more information on CF cards, see *CF Cards and Estimated Capacities (Recordable Images)* (p. 203).

### About CF Cards...

- CF cards are high-precision electronic devices. Do not bend them, apply force to them, or subject them to shocks or vibration.
- Do not attempt to disassemble or alter a CF card.
- Moving a CF card rapidly between temperature extremes will cause condensation to form in the card and lead to a malfunction. To avoid condensation, place the CF card in a sealed plastic bag before moving it into a different temperature zone and allow it to adjust slowly to the new temperature. If condensation forms on the CF card, store it at room temperature until the water droplets have evaporated naturally.
- Do not use or store CF cards in the following locations.
  - Locations subject to dust or sand
  - Locations subject to high humidity and high temperatures

## Setting the Date/Time

The Date/Time menu will appear the first time the camera power is turned on or whenever the built-in rechargeable lithium date/time battery charge is low. Start from Step 5 to set the date and time.

- 1** Press the **ON/OFF** button to turn on the camera (p. 31).
- 2** Open the **LCD** monitor (p. 34) and press the **MENU** button.

The [  (Rec.) ] or [  (Play) ] menu appears.



[  (Rec.) ] menu in Auto mode shown.

- 3** Select the [  (Set up) ] menu using the left or right button.



- 4** Press the up or down button to select  (Date/Time), and then press the **SET** button.



- 5** Set the date and time.

- Use the up or down button to change the value of the highlighted field.
- Press the left or right button to highlight another field.
- The date can be set up to the year 2030.

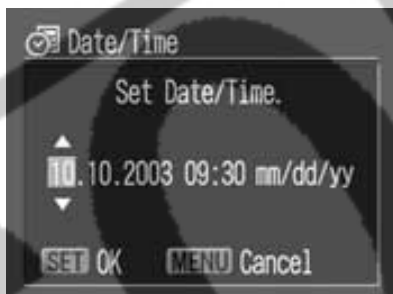

- 6** Press the **SET** button.

After adjusting the settings, press the **MENU** button to close the menu window.



- The date, time and other camera settings may reset to the default settings if the batteries have been removed for more than three weeks.
- Setting the date and time settings does not cause the date/time stamp to appear on images. For printing images with the date on them, refer to the *Direct Print User Guide* and *Software Starter Guide*.



### **Charging the date/time battery**

- The camera has a built-in rechargeable lithium battery for saving settings such as the date and time. This battery is recharged by the AA-size batteries while it is in the camera. Right after purchasing the camera, leave fully charged batteries in the camera, or plug in the AC Adapter Kit ACK600 (sold separately), for about 4 hours to charge the date/time battery. It will charge even when the camera power is turned off.
- If the Date/Time menu appears when the camera power is turned on, the date/time battery charge is low. Use the above method to recharge it.

## Setting the Language

Use this feature to select the language for the LCD monitor display.

**1** Press the ON/OFF button to turn on the camera (p. 31).

**2** Open the LCD monitor (p. 34) and press the MENU button.

The [  (Rec.) ] or [  (Play) ] Menu will display.



[  (Rec.) ] menu in Auto mode shown.

**3** Select the [  (Set up) ] menu using the left or right button.



- 4** Select  (Language) using the up or down button and press the **SET** button.



- 5** Select a language using the up, down, left or right button.



- 6** Press the **SET** button.

After adjusting the settings, press the **MENU** button.



#### Shortcut Operation

The Language menu can also be displayed in Playback mode by holding down the **SET** button and pressing the **MENU** button. This function cannot be used while a movie clip is played back, or a separately sold printer is connected to the camera.



# Basic Functions

## Turning the Power On

- 1** Press the ON/OFF button until the power indicator lights.

### Shooting Mode

If the LCD monitor is open, the current shooting mode settings appear for about 6 seconds.



If you slide the mode switch to , the lens will retract after approximately 1 minute.

### Playback mode

The LCD monitor displays an image.  
The LCD monitor must be opened (p. 34).

### Turning the Camera Off

Press the ON/OFF button again to turn the power off.



- You will hear a start-up sound and see the start-up image when the power is turned on. (To change the start-up sound and image, see below and pages 157 and 176.)
- The start-up image does not appear when the LCD monitor is off or the camera is connected to a TV.

### **Turning on the camera without the start-up sound and image**

Press and hold the **SET** button, then turn on the power.

### **Power Saving Function**

This camera is equipped with a power saving function. When this function is turned on and it activates, restore power by pressing the ON/OFF button.

### **Shooting Mode**

The power will automatically turn off approximately 3 minutes after the last function is accessed. The LCD monitor will turn off approximately 1 minute\* after the last function is accessed. Press any button other than the ON/OFF button to turn the LCD monitor back on.

\* This time can be changed (p. 173).

### **Playback Mode**

The power will automatically turn off approximately 5 minutes after the last function is accessed.

### **While Connected to a Printer**

The power will automatically turn off after approximately 5 minutes of inactivity for both the camera and the printer.

- The power saving function will not activate while the camera is in Auto Play mode or during a computer connection (p. 134, 150).
- You can turn off the power saving function in the [  (Set up)] menu (p. 173).

## Switching between Shooting and Playback

You can quickly switch between Shooting mode and Playback mode. This is convenient when you wish to shoot again after checking or deleting an image immediately after it is shot.

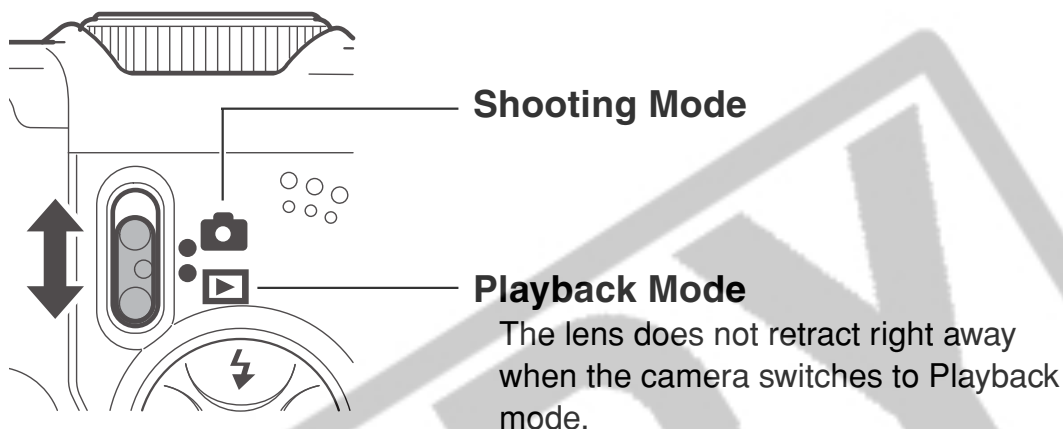



### When shooting (Shooting mode)

- Slide the mode switch to .

### When playing back (Playback mode)

- Open the LCD monitor and slide the mode switch to .
- When a printer (sold separately) is connected, images can be printed (refer to the *Direct Print User Guide*).
- When a camera is connected, recorded images can be downloaded to and viewed with a computer (p. 150).



- When a printer (sold separately) is properly connected, , , or  appears on the LCD monitor.
- When a computer is properly connected, the LCD monitor turns off.

## Using the LCD Monitor

The LCD monitor can be used to check an image during shooting, to play back recorded images or to adjust menu settings.

It can be opened to the following range of positions.

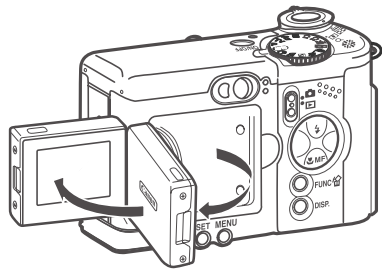

Opened right to left 180 degrees.

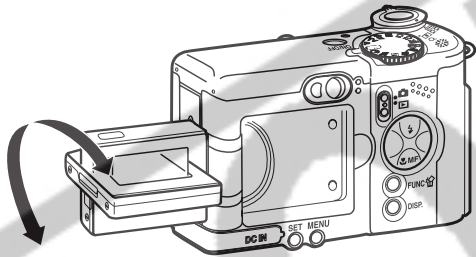

Tilted forward 180 degrees toward the lens or backward 90 degrees.

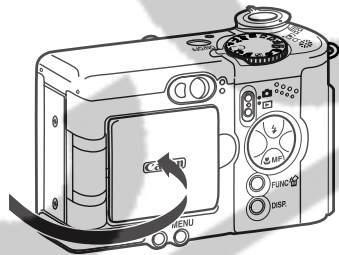

The LCD monitor will automatically turn off when it clicks shut against the camera body. For protection, always close the LCD monitor after use.

The LCD monitor can also be positioned as below.

**1** Open the LCD monitor left 180 degrees and tilt it 180 degrees toward the lens.

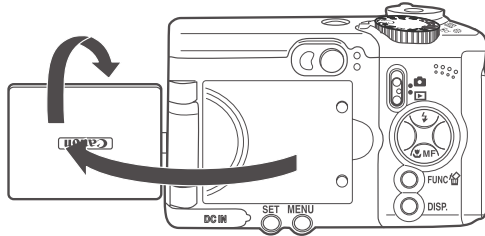

- In this position, icons and messages do not appear on the LCD monitor.
- The image shown on the LCD monitor is automatically flipped and reversed so that it appears correctly from in front of the lens. (This reverse display function can be turned off. (p. 169))

**2** Fold the LCD monitor back against the camera body.

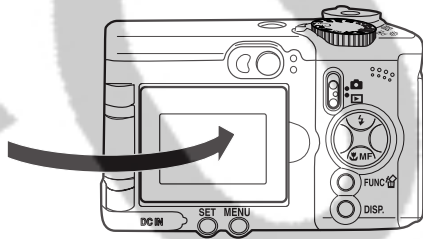

- Fold it until it clicks into place against the camera body. If it is not fully closed, the image will appear reversed and icons and messages will not display.
- Icons and messages will appear and images will show properly (not reversed) when the LCD monitor is folded right against the camera until it clicks.





The image in the LCD monitor may darken when the monitor is used under sunlight or other strong lighting. This is not a defect.

## Shooting Mode

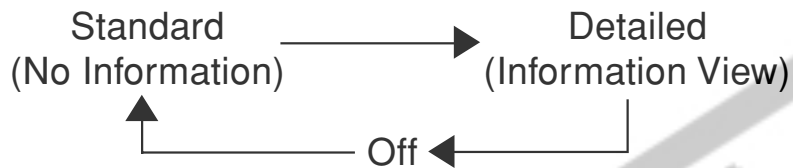
Pressing the **DISP.** button cycles the LCD monitor to the next mode each time the button is pressed.



- The on/off setting of the LCD monitor display mode is memorized when the camera is turned off. When the camera is turned on again it assumes the last mode. However, when the LCD monitor is turned on and the “Change the Batteries” message appears, the LCD monitor may not automatically turn on the next time the camera is started.
- Setting the mode dial to  or  modes turns the LCD monitor on regardless of whether it is set to on or off.

## Playback Mode

- The LCD monitor always comes on when you slide the mode switch to .
- Pressing the **DISP.** button cycles the information view mode each time the button is pressed.

### Single Image Playback



### Index Playback (9 images)





## Information Displayed on the LCD Monitor

### Shooting Mode

When a Shooting mode setting is changed, the settings appear on the LCD monitor for about 6 seconds even if the LCD monitor is set to Standard or No display. (The Shooting mode settings may not appear depending on the camera setting.)

**You can set the flash, Macro mode, and the manual focus settings while this information appears on the LCD monitor.**



A slow shutter speed has likely been selected because of insufficient lighting if the upper indicator beside the viewfinder blinks orange after the metering preparations are complete and the camera shake icon  displays in the LCD monitor. Set the flash to  or , or affix the camera to a tripod to shoot.



- After you press the shutter button and take a shot, the recorded image appears on the LCD monitor for 2 to 10 seconds (1-second increments). It will continue to display if you press the **SET** button while it is shown on the screen. See *Changing the Image Display Duration* (p. 59).
- While a recorded image is displayed on the LCD monitor, you can check the exposure with the graph (See *About the Histogram* (p. 41)). That shows the distribution of the brightness data. If the exposure requires adjustment, set the exposure compensation and reshoot (Press the **DISP.** button if the histogram and other information is not shown.).

The following displays in information view.

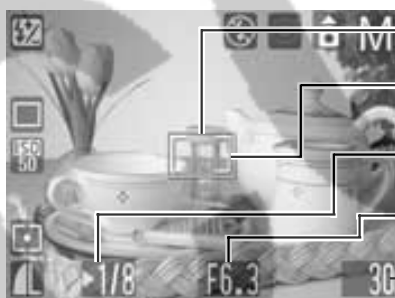

- AF Frame
- Spot AE Point Frame
- Shutter Speed
- Aperture Setting
- Shots Remaining or Remaining Movie Time (sec.)



	Shooting Mode	p. 19
-2 ... +2	Exposure Compensation	p. 99
	White Balance	p. 102
	Drive Mode	p. 80/84
	ISO Speed	p. 109
	Photo Effects	p. 107
	Light Metering Mode	p. 97
	Compression	p. 60
	Resolution	p. 60
	Flash	p. 64
	Red-Eye Reduction	p. 65
	Macro Mode	p. 78
	Auto Rotate Function	p. 118
	Manual Focus	p. 114
	Movie Recording Mode	p. 76
4.3x 5.3x 6.7x 8.2x 11x	Digital Zoom Setting*	p. 82
	Camera Shake Warning	p. 38
	Low Battery	p. 23

- The icons in the shaded boxes above appear even when the information view is turned off.
- In addition to the above, the AF frame, spot light metering frame (**P**, **Av** and **Tv** mode), shutter speed, aperture setting (**Av**, **Tv** and **M** mode), shots remaining or remaining movie time are displayed as in the example to the left.

\* Zoom powers reflect the combined optical and digital zoom effects. These figures appear when the digital zoom is activated.

## Playback Mode

In standard display mode, the following information appears.











File Number		Compression	p. 60
		Resolution (Still images)	p. 60
		Sound memo (WAVE file)	p. 132
		Movie	p. 126
		Protection status	p. 135

Image Number and Total (Display Image/Total)

In detailed display mode, the following information appears.

	Histogram	
	Shutter Speed	
	Aperture Value	
	Movie Length	

	Shooting Mode	p. 19
-2 ... ±0 ... +2	Exposure Compensation	p. 99
	White Balance	p. 102
	Photo Effects	p. 107
	ISO Speed	p. 109
	Flash	p. 64
	Macro Mode	p. 78
	Manual Focus	p. 114
	Light Metering Mode	p. 97
	Resolution (Movies)	p. 60

In addition to the above, the shutter speed, aperture setting, histogram, and recorded movie time are displayed.

The following information may also appear with some image files.

♪?	An audio file other than a wave file, or a file with an unrecognized format, is attached.
⚠	A JPEG file not supported by “Design rule for Camera File system” (DCF) standards.
RAW	RAW format file
?	A file with an unrecognized format.



Please note that image information recorded by this camera may not display correctly on other cameras and image information recorded by other cameras may not display correctly on this camera.

### About the Histogram

The histogram is a graph that allows you to judge the brightness of the shot image. The greater the bias toward the left in the graph, the darker the image. The greater the bias toward to the right, the brighter the image. If the image is too dark, adjust the exposure compensation to a positive value. Similarly, adjust the exposure compensation to a negative value if the image is too bright (p. 99).

### Sample histograms



Dark image



Balanced image

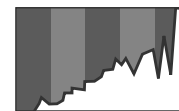

Bright image

## Using the Viewfinder to Shoot

Setting the LCD monitor to off (p. 36) and using the optical viewfinder can help conserve power while shooting.

- 1 Align the square brackets (autofocus metering field) inside the viewfinder on the primary subject to compose the image.**

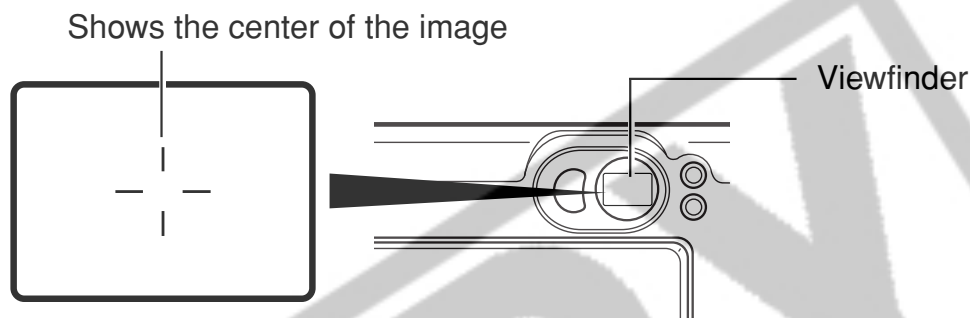

### About the Autofocus Function

This camera employs AiAF (artificial intelligence autofocus) technology which uses a broad metering field to calculate the focal distance with high precision. It delivers a crisp focus even when the photographic subject is slightly off-center.

### Image Seen in Viewfinder vs. Recorded Image

Usually the recorded image is wider than the image seen in the viewfinder. Confirm the actual image size with the LCD monitor.

The image recorded may differ from the image seen in the viewfinder due to the distance between the viewfinder and lens (especially with close-ups). If you use the viewfinder to take close-up shots, portions of the close-up subject may not appear in the recorded image. For this reason it is better to use the LCD monitor when taking close-up shots.

## Using the Zoom

The zoom can be adjusted from 38 mm to 114 mm in 35mm film equivalent terms.

### Wide/Telephoto Angle

 : **Wide-angle**  
Press the zoom lever left to zoom out for a wide-angle shot.

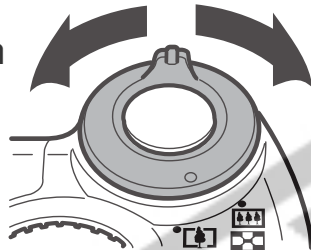

 : **Telephoto**  
Press the zoom lever right to zoom in for a telephoto shot.



Wide-angle



Telephoto

### Digital Zoom

When the LCD monitor is on you can digitally zoom in on a subject. The combined optical and digital zoom is approximately 11 times the wide angle setting (p. 82).



Digital zoom is unavailable in some modes (p. 212).



Images become coarser, the more they are digitally zoomed.

# Pressing the Shutter Button

The shutter button features a two-stage action.

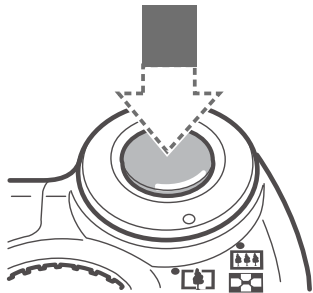

## Pressing Halfway

Pressing halfway automatically sets the exposure, focus and white balance.

The indicators light or blink as follows.

### Upper Indicator

- Green: Metering complete (two beeps sound)
- Orange: Flash will fire
- Blinking Orange: Camera shake warning / Insufficient exposure

### Lower Indicator

- Yellow: Macro Mode / Manual Focus
- Blinking Yellow: Focusing difficulty\* (single beep sounds)

\* When the indicator blinks yellow, lock the focus before shooting (p. 112).

The AF frame



The AF frame appears as follows when the LCD monitor is on.

When AiAF is on (p. 96)

- Green: Metering complete (Focused AF frame or frames)
- No AF frame: Focusing difficulty

When AiAF is off (p. 96)

(Center focus AF)

- Green: Metering complete
- Yellow: Focusing difficulty

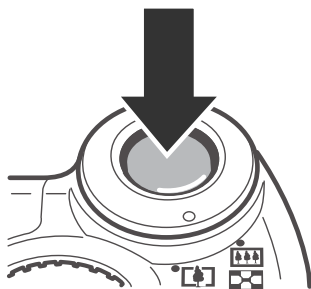

## Pressing Fully

Pressing fully releases the shutter.

- You will hear the shutter sound when the shot is complete. Do not move the camera until you hear this sound.
- The upper indicator blinks green while the image is recording onto the CF card.



- If the orange or yellow indicator blinks while you press halfway, you can still press fully to take the shot.
- Images are first saved into the camera's internal memory before being recorded onto the CF card, allowing the next images to be taken immediately as long as sufficient space is available in the internal memory.
- The beep and shutter sound can be set on/off in the Set up menu (p. 172).
- Even when the shutter sound is set to [1], [2], [3] (On) (p. 157) and [Mute] is set to [On], no sound will be heard.
- There is no shutter sound in movie mode.
- Shots cannot be taken while the flash is charging.

#### **AF-Assist Beam**

- The AF-assist beam will sometimes emit when the shutter button is pressed halfway to assist focusing in certain conditions, i.e. dark conditions.
- The AF-assist beam can be turned off (p. 168).  
For example, if animals are your subject, turn off the beam when shooting in the dark to avoid startling them. However, please keep in mind the following facts.
  - Turning the AF-assist beam off may make it more difficult for the camera to focus in a dark place.
  - The red-eye reduction lamp may emit when you press the shutter button halfway even if the AF-assist beam is turned off.

In order to prevent any lamp from emitting before the flash fires, set both the red-eye reduction function and the AF-assist beam to [Off] in the Shooting menu.



## Selecting Menus and Settings

Menus are used to adjust shooting, playback, date/time and electronic sound settings. Menus can be displayed by either pressing the **FUNC.** button or the **MENU** button. Watch the LCD monitor while performing the following procedures.

### Selecting Settings by Pressing the **FUNC.** Button (Only in Shooting Mode)

- 1** Open the LCD monitor and press the **FUNC.** button.



- Icons of the selectable settings appear on the left side of the LCD monitor.
- The current settings icons appear.

- 2** Select a menu item using the up or down button.

### 3 Select setting contents using the left or right button.

Some menu items can only be selected after pressing the **SET** button and displaying the next menu. Press the **SET** button again to confirm the setting.





### 4 Press the **FUNC.** button.

- The menu closes.
- Images can be shot immediately with the selected settings after Step 3 by pressing the shutter button.





## Selecting Settings by Pressing the **MENU** Button

### 1 Open the LCD monitor and press the **MENU** button.

In Shooting mode, the [  (Rec.)] menu appears. In Playback mode, the [  (Play)] menu appears.

### 2 Switch between menu tabs using the left or right button.



- The menu switches as follows:  
[  (Rec.) ] or [  (Play) ] ↔ [  (Set up) ] ↔ [  (My Camera) ]
- Pressing the zoom lever also switches between the menu tabs.

### 3 Select a menu item using the up or down button.



### 4 Select setting contents using the left or right button.



For the items followed by an ellipsis (...), press the **SET** button to show submenus and select a setting. After selecting, press the **SET** button again to confirm the setting. Some of the items followed by an ellipsis (...) may be selected by using the up and down buttons instead of the left and right buttons.

### 5 Press the **MENU** button.

- The menu closes.
- In Shooting mode, the menu can be closed by pressing the shutter button halfway.

## Selecting Menus and Settings (continued)

### Displaying a MENU

### Switching

#### Shooting Mode

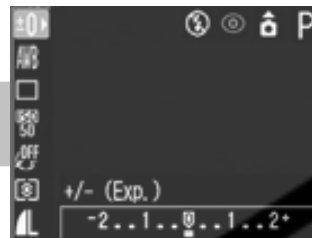
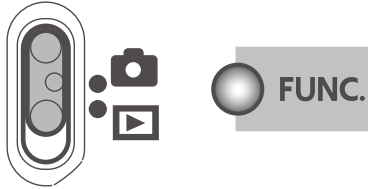

FUNC. Menu

#### Shooting Mode



Rec. Menu\*  
Selectable items vary according to each mode.

#### Playback Mode



Play Menu\*



between Menus	Setting Options	Completing the Procedure
---------------	-----------------	--------------------------



Set up Menu\*

My Camera Menu\*

\* Use the zoom lever to switch between menus anytime.

























Preparing the Camera, Basic Functions

## Menu Settings and Default Settings

This chart shows the options for each menu and the default settings.

















Some menu items are not available in certain Shooting modes (p. 212).

### FUNC. button

Menu Item	Available Settings	Reference Page
Exposure Compensation	-2 to $\pm 0^*$ to +2	99
Flash Output	Low* / Medium / Strong	111
White Balance	AWB* /  /  /  /  /  / 	102
Drive Mode	 * /  /  /  / 	80, 84
ISO Speed	AUTO / 50* / 100 / 200 / 400	109
Photo Effect	OFF* /  /  /  /  /  / 	107
Light Metering System	 * /  / 	97
Resolution, File Format, Compression	(Still picture) L* / M1 / M2 / S (Movie)  * /  (Compression)  /  * / 	60

\* Default setting

## MENU button



	Menu Item	Available Settings	Reference Page
 <b>Rec. Menu</b>	 AiAF	On*/Off	96
	 Red-eye	On*/ Off	65
	 MF-Point Zoom	On*/ Off	115
	 AF-assist Beam	On*/ Off	168
	 Digital Zoom	On / Off*	82
	 Review	Off / 2* to 10 sec.	59
	 Reverse Disp.	On*/ Off	169
	<b>C</b> Save Settings	Saves customized settings	116
 <b>Play Menu</b>	 Protect	Turns image protection on and off	135
	 Rotate	Rotates the image in the display	131
	 Sound Memo	Adds sound memos to images	132
	 Erase all	Erases all images on the CF card	137
	 Auto Play	Automatically plays back images in a slide show	134
	 Print Order	Sets the print settings	142
	 Transfer Order	Sets the transfer settings	148

\* Default setting

	Menu Item	Available Settings	Reference Page	
<b>Set up Menu</b>	Mute	On / Off*	172	
	Volume	Start-up Vol.	Off / 1 / 2* / 3 / 4 / 5	172
		Operation Vol.		
		Selftimer Vol.		
		Shutter Vol.		
		Playback Vol.		
	Power Saving	Auto Power Down	On* / Off	173
		Display Off	10sec/20sec/30sec/ 1min*/2min/3min	173
	Date/Time	Sets the date and time	26	
	Format	Formats the CF card	138	
File No. Reset	On / Off*	120		
Auto Rotate	On* / Off	118		
Distance Units	m/cm* / ft/in	174		
Language	English* / Deutsch / Français / Nederlands / Dansk / Suomi / Italiano / Norsk / Svenska / Español / Chinese / Japanese	29		
<b>My Camera Menu</b>	Video System	NTSC / PAL	175	
	Theme	/ <b>1</b> * /  /	157 176 177	
	Start-up Image	/ <b>1</b> * /  /		
	Start-up Sound	/ <b>1</b> * /  /		
	Operation Sound	/ <b>1</b> * /  /		
	Selftimer Sound	/ <b>1</b> * /  /		
	Shutter Sound	/ <b>1</b> * /  /		

\* Default values. Default video system settings vary between regions.



- You can apply a desired image and sound to  and  in the My Camera menu. For details, see *Registering My Camera Settings* (p. 160) or the *Software Starter Guide*.
- Various camera settings can be restored all at once (p. 178).

# Shooting-Letting the Camera Select Settings

See *Functions Available in Each Shooting Mode* (p. 212) at the end of this manual to find out which settings can be changed in which shooting modes.

## **AUTO** Auto Mode

Available in the following modes.

**AUTO**

In this mode, all you have to do is press the shutter button and let the camera do everything else.

- 1** Check that the camera is in Shooting mode (p. 33).
- 2** Turn the shooting mode dial to **AUTO**.

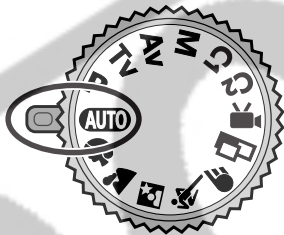

- 3** Aim the camera at the subject.
- 4** Use the zoom lever to achieve the desired composition (relative subject size in the viewfinder).

## 5 Press the shutter button halfway (p. 44).

- Press the button halfway to make the camera focus on a subject. Two beeps will sound when the camera has finished metering and the indicator next to the viewfinder will light green or orange. If the LCD monitor is on, the AF frame or frames will appear green.
- The indicator beside the viewfinder will blink yellow and one beep will sound if the subject is difficult to focus on.

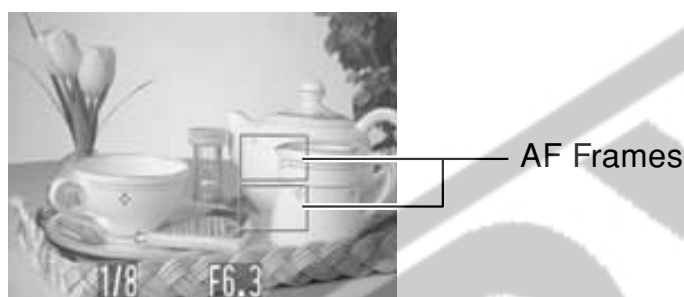

## 6 Press the shutter button all the way (p. 45).

- You will hear the sound of the shutter when the shutter releases.
- The picture appears for two seconds on the LCD monitor.



- For functions available in this mode, see page 212.
- You can change the length of time images show on the LCD monitor after shooting, or set it so they do not show at all (p. 58).

## Reviewing an Image Right After Shooting

Available in the following modes.



After a photo is taken, the image displays on the LCD monitor for two seconds. There are two ways to display the image for longer as explained below.

- **Keeping the shutter button pressed**

The image continues to appear on the LCD monitor as long as you keep the shutter button fully depressed.

- **Pressing the SET button while the image is displayed**

If you press the SET button while the image is displayed on the LCD monitor, it will continue to display even after the shutter button is released.

Press the shutter button halfway again to stop displaying it.



You can perform the following while images are displayed.

- Erasing Images Individually (p. 15, 136)
- Magnifying Images (p. 123)

## Changing the Image Display Duration

The length of time images are displayed after a photo has been taken can be changed from between 2 seconds to 10 seconds or turned off.

**1** In the [  (Rec.)] menu, select  (Review).

See *Selecting Menus and Settings* (p. 47)

**2** Select a Review setting and press the **MENU** button.



- With the [Off] option, the image will not automatically display.
- With the [2 sec.] to [10 sec.] options, the image will appear for the time selected.
- You can continue to display the image as long as the shutter button is fully held pressed regardless of the Review setting.
- Another picture can be taken even while the last is displayed.

## Changing the Resolution and Compression

Available in the following modes.





You can change the resolution and compression (excluding movies) settings to suit the purpose of the image you are about to shoot.

Resolution		Purpose	
<b>L</b> (Large)	2272 x 1704 pixels	High  Low	<ul style="list-style-type: none"> <li>• Print up to A4 size* 210 x 297 mm (8.3 x 11.7 in.) prints</li> <li>• Print up to Letter size* 216 x 279 mm (8.5 x 11 in.) prints</li> </ul>
	<b>M1</b> (Medium 1)		<ul style="list-style-type: none"> <li>• Print postcard size 148 x 100 mm (6 x 4 in.) prints</li> <li>• Print L-size 119 x 89 mm (4.7 x 3.5 in.) prints</li> </ul>
	<b>M2</b> (Medium 2)		<ul style="list-style-type: none"> <li>• Print card size 86 x 54 mm (3.4 x 2.1 in.) prints</li> </ul>
	<b>S</b> (Small)		<ul style="list-style-type: none"> <li>• Send images as e-mail attachments</li> <li>• Shoot more images</li> </ul>

\* Paper sizes vary according to region.

Compression			Purpose
	Superfine	High Quality  Normal	Shoot higher quality images
	Fine		Shoot normal quality images
	Normal		Shoot more images

Movies can be shot with the following resolutions.

Resolution	
	320 x 240 pixels
	160 x 120 pixels

- 1** Open the LCD monitor.
- 2** Set the shooting mode dial to the desired Shooting mode.
- 3** Press the **FUNC.** button.
- 4** Select  L\* (2272 x 1704) using the up or down button.



\* The current setting is displayed.

- 5** Select the resolution you wish to set using the left or right button.

Excluding 

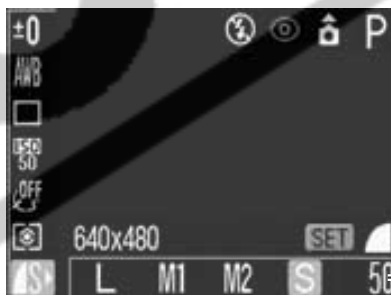

Number of shots remaining  
(Only displayed when the resolution,  
compression or file format is selected)

**6** Press the **SET** button.

**7** Select the compression you wish to set using the left or right button.



- You can shoot the image right after selecting settings by pressing the shutter button. This screen will appear again, once the image is shot.
- Pressing the **SET** button returns to Step 4 where you can change the resolution setting.

**8** Press the **FUNC.** button.

**9** Shoot the image.





- Some settings are not available with certain Shooting modes. Please refer to *Functions Available in Each Shooting Mode* (p. 212)
- Size of an image file (approximate) (p. 203)
- Types of CF cards and resolution (p. 203)
- The resolution and compression settings are affected by the shooting mode selection as follows (only the resolution is affected in **P** mode):
  - Ex.1: When changed from **AUTO** to **M**, the resolution and compression settings of **M** are used.
  - Ex.2: When changed from **P** to **Tv**, the resolution and compression settings of **P** are used.

Current Shooting Mode	Next Shooting Mode	Resolution and Compression after Change
<b>AUTO</b> C1 C2	<b>AUTO</b> <b>P Tv Av M C1 C2</b>	Settings change to those of the next mode
 	 <b>AUTO P Tv Av M C1 C2</b>	Settings do not change
<b>P Tv</b> <b>Av M</b>	<b>P Tv Av M</b>	Settings do not change
	<b>AUTO</b> <b>C1 C2</b>	Settings change to those of the next mode

## ⚡ Using the Flash

Available in the following modes.



Use the flash according to the guidelines below.

	Auto with red-eye reduction	The flash fires automatically as required by the lighting level, and the red-eye reduction lamp fires each time the main flash fires.
	Auto	The flash fires automatically as required by the lighting level.
	Flash on with red-eye reduction	The red-eye reduction lamp and the flash always fire.
	Flash on	The flash always fires.
	Flash off	The flash does not fire.

**1** Open the LCD monitor and press the ⚡ button to switch between flash modes.



- The selected flash mode appears on the LCD monitor.
- You can switch between settings by pressing the ⚡ button.

**When the red-eye reduction function is on**



When the red-eye reduction function is off

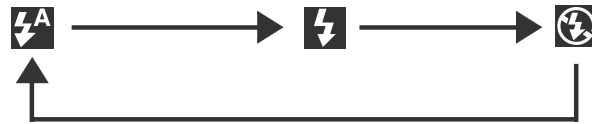

This operation may not work in certain shooting modes (p. 212).

## 2 Shoot the image.

- The flash will fire if the indicator beside the viewfinder lights orange when the shutter button is pressed halfway. (Does not fire in .)
- Shooting procedures are the same as for the **AUTO** mode (p. 56).

### Setting the Red-eye Reduction Function

The red-eye reduction lamp fires when the flash is used in dark areas. This prevents light from reflecting back from the eyes and making them appear red.

**1** In the [  (Rec.) ] menu, set  (Red-eye) to [On].



When shooting with a high ISO sensitivity and using the flash, there is more of a chance of overexposure the closer you are to the subject.



---

### • Red-Eye Reduction

When shooting with the red-eye reduction function, the subjects must look right at the red-eye reduction lamp for this mode to be effective. Try asking them to look directly at the lamp. Even better results can be obtained by shooting with the lens set to a wide angle, increasing the lighting in indoor settings or approaching closer to the subject.

- Some settings are not available with certain shooting modes. Please refer to *Functions Available in Each Shooting Mode* (p. 212).
  - The flash fires twice. A pre-flash will fire and will be followed by the main flash. The pre-flash is used by the camera to obtain the subject's exposure data so that the main flash can be set to the optimal intensity for the shot.
  - When shooting with the flash, the distance between the camera and the subject should be at least 45 cm (1.5 ft.) for normal shooting and 25 cm (10 in.) for Macro shooting.
  - The fastest shutter speed for flash synchronization is 1/500 second. The camera automatically resets the shutter speed to 1/500 second if a faster speed is selected.
  - The flash fires with automatic adjustments when shooting in modes other than the **M** mode. When shooting in **M** mode, the flash fires with the manually set adjustments.
  - In **M** mode, the [Flash Output] option can be changed (p. 111).
  - Shots cannot be taken while the flash is charging.
  - The flash may take up to approximately 10 seconds to charge in some cases. Actual times will vary according to usage and the battery charge.
  - The flash setting is saved when the camera is turned off in the **P**, **Tv**, **Av** and **M** Shooting modes.
-

## Portrait Mode

Available in the following modes.



Use this mode when you want the subject to appear sharp and the background to blur.

**1** Turn the shooting mode dial to .

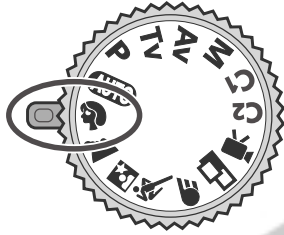

Shooting

Shooting procedures are the same as for the **AUTO** Mode (p. 56).



- For functions available in this mode, see page 212.
- To best achieve the effect of the background gradually blurring, compose the image so that the upper half of the subject's body fills most of the viewfinder or LCD monitor.
- The background gets increasingly blurred the more you adjust the focal length toward telephoto.

## Landscape Mode

Available in the following modes.



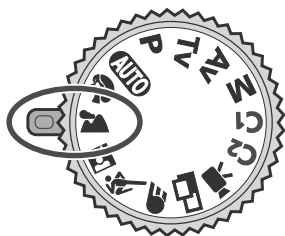

Use this mode to shoot spacious landscape scenes.

**1** Turn the shooting mode dial to .



Shooting procedures are the same as for the **AUTO** Mode (p. 56).



- For functions available in this mode, see page 212.
- Since a slow shutter speed is often selected in  mode, use a tripod to shoot if the  (camera shake warning) icon appears on the LCD monitor.

## Night Scene Mode

Available in the following modes.



Use this mode to capture human subjects against the backdrop of an evening sky or night scene. The subject is illuminated with light from the flash while the backdrop is captured at a slow shutter speed so that both appear correctly exposed.



Shooting

**1** Turn the shooting mode dial to .

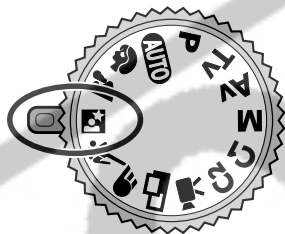

Shooting procedures are the same as for the **AUTO** mode (p. 56).

### **To shoot a night scene without a subject**

To shoot a night scene without any subject in the foreground, set the flash to . (A night scene usually consists of light sources in the night. When shooting with the flash, the light of the flash will wash out these lights, so it is better to turn the flash off.)

This mode uses a slow shutter speed so always use a tripod to prevent camera shake.



Always use a tripod to prevent camera shake in this mode.



- For functions available in this mode, see page 212.
- Warn people to stay still for a few seconds after the flash fires because of the slow shutter speed.
- Using the  mode in daylight will produce an effect similar to that of the **AUTO** mode.

## Fast Shutter

Available in the following modes.



Use this mode to shoot fast moving objects.

**1** Turn the shooting mode dial to  .

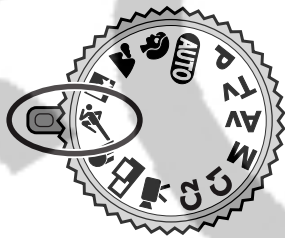

Shooting procedures are the same as for the **AUTO** mode (p. 56).



- For functions available in this mode, see page 212.
- Noise in the recorded image may increase if you shoot dark subjects.



## Slow Shutter

Available in the following modes.



Use this mode to shoot moving objects to make them appear blurred, such as river rapids.

**1** Turn the shooting mode dial to .

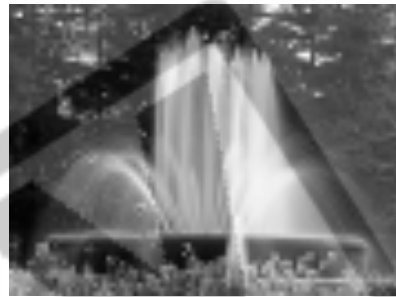
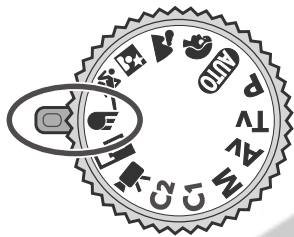

Shooting

Shooting procedures are the same as for the **AUTO** mode (p. 56).



Always use a tripod to prevent camera shake in this mode.



For functions available in this mode, see page 212.

## Panoramic Images (Stitch Assist Mode)

Available in the following modes.



Use this mode when taking shots that you want to combine into a panorama. To create the panorama itself, you must stitch the images together with your computer.

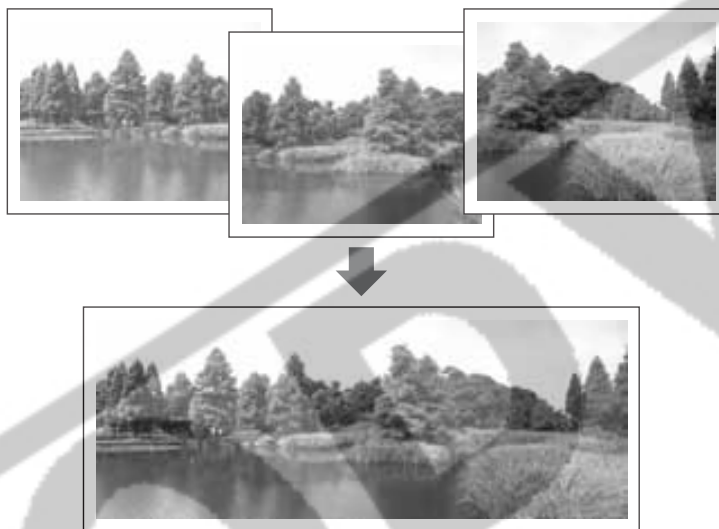

To create the panorama with your computer, use the PhotoStitch software that came with your camera.

### **Framing a Subject**

The PhotoStitch program detects the overlapping portions of adjoining images and merges them. When shooting, try to include a distinctive item (landmark) in the overlapping portions.





- Compose each frame so that it overlaps 30 to 50% of the adjoining image. Try to keep the vertical misalignment to within 10% of the image height.
- Do not include moving items in the overlap.
- Do not try to stitch images that include both distant and close items. Objects may appear warped or doubled up.
- Make the brightness in each image consistent. The final image will appear unnatural if the difference in brightness is too great.
- For good results, pan (swivel) the camera to take successive shots.
- To shoot close-ups, slide the camera over the subject, keeping it parallel as you move.

## Shooting

- 1** Open the LCD monitor and turn the shooting mode dial to .

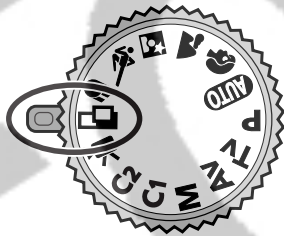

The LCD monitor will be on.

## 2 Select the shooting sequence using the left or right button and press the SET button.



You can also press the shutter button directly to shoot without pressing SET.

## 3 Shoot the first image.

The exposure and white balance settings are set and locked with the first image.

## 4 Compose and shoot the second image so that it overlaps the first.



- Minor discrepancies in the overlap can be corrected with the software.
- An image can be retaken. Press the left or right button to return to that frame.

## 5 Use the same procedures to shoot the remaining frames.

A maximum of 26 images can be recorded either horizontally or vertically.

## 6 Press the **SET** button after the last shot.



- A custom white balance setting (p. 104) cannot be set in  mode. To use a custom white balance setting, first set it in another shooting mode.
- The settings in place for the first image are locked in and cannot be changed for subsequent shots.
- A TV cannot be used as the monitor for shooting in this mode.





For functions available in this mode, see page 212.

## Movie Mode

Available in the following modes.



Use this mode to shoot movies. The resolution can be set to either [  (320 × 240)] or [  (160 × 120)] (p. 60).

- 1** Open the LCD monitor and turn the shooting mode dial to .

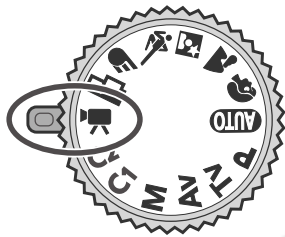

The LCD monitor will be on and displays the maximum recording time (in seconds).

- 2** Press the shutter button all the way.

- Shooting and sound recording starts simultaneously.
- During the shooting a red circle appears in the upper right of the LCD monitor.

- 3** Press the shutter button all the way to stop recording the movie.

- The maximum length of individual movie clips (approximately 15 frames/second) is about 3 minutes. These times may vary with the subject and shooting conditions. Recording will automatically stop when the maximum is reached or when the CF cards runs out of free capacity.



- Although the recording time may not display properly during shooting, the movie will be recorded correctly.
- Recording may stop unexpectedly with certain types of CF cards (slow recording cards, cards formatted on a different camera or a computer, or cards which have had images recorded and erased repeatedly).
- You are recommended to use a CF card that has been formatted in your camera to shoot movies (p. 138). The card supplied with the camera may be used without further formatting.
- Be careful not to touch the microphone while shooting.
- The AE, AF, white balance and zoom settings are set and locked to the settings of the first frame.
- If the indicator on the left side of the viewfinder blinks green after a shot, this indicates that the movie is being written to the CF card. You cannot shoot again until it stops blinking.



- For functions available in this mode, see page 212.
- Sound is recorded monaurally.
- There is no shutter sound in movie mode.
- QuickTime 3.0 or higher is required to playback movie files (AVI/Motion JPEG) on a computer. (QuickTime (for Windows) is bundled on the supplied Digital Camera Solution Disk. On the Macintosh platform, QuickTime 3.0 or later is generally bundled with the Mac OS 8.5 or later operating system.)

## Macro Mode

Available in the following modes.





Use the macro mode to shoot close-ups of subjects in the range of 5 to 45 cm (2.0 in. to 1.5 ft.) at wide angle end and 25 to 45 cm (10 in. to 1.5 ft.) at telephoto end. Use to take close-up shots of flowers or small objects.

**1** Open the LCD monitor and press the **DISP.** button to turn the LCD monitor on.

**2** Press the  button.

- The  icon appears on the LCD monitor.



- Pressing the  button until the  icon on the LCD monitor disappears cancels the macro mode.

**3** Shoot the image.

- The indicator beside the viewfinder will light yellow when the shutter button is pressed halfway.
- Shooting procedures are the same as for the **AUTO** Mode (p. 56).



### Advanced technique for the macro mode

Macro mode can make unique images when used with the zoom function. For example, shooting a flower at maximum wide angle in Macro mode allows the camera to bring both the flower and the background into focus. However, shooting at maximum telephoto can throw the background out of focus to make the flower stand out.



Macro with the wide angle zoom

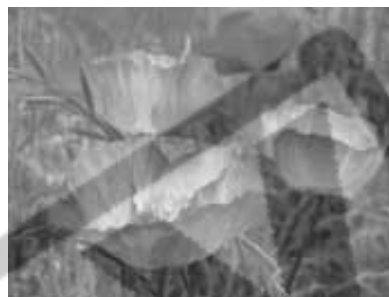

Macro with the telephoto zoom



- Some settings are not available with certain shooting modes. Please refer to *Functions Available in Each Shooting Mode* (p. 212).
- Always use the LCD monitor to compose images in macro mode. Shooting with the viewfinder is possible, though images composed with the optical viewfinder may be off-center (p. 42).
- When the lens is zoomed out to the wide angle end, the recordable area is 56 × 42 mm (2.2 in. × 1.6 in.)\*<sup>1</sup>, and at telephoto end, it is 87 × 65 mm (3.4 in. × 2.6 in.)\*<sup>2</sup>. When the zoom is set between the telephoto end and the wide-angle end, the distance from lens to subject is the same as when the zoom is set to the telephoto end.
- The exposure may not be optimal when the flash is used in macro mode.

\*<sup>1</sup> Maximum wide angle setting.

\*<sup>2</sup> Maximum optical telephoto setting.

## Self-Timer

Available in the following modes.



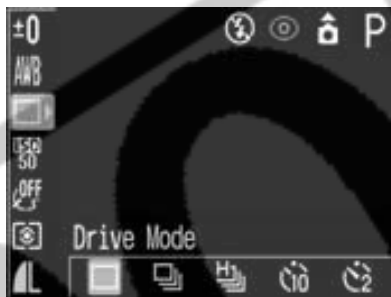

With this function, images are shot 10 or 2 seconds after the shutter button is pressed. This is useful when you want to take a memorable photo with everyone including yourself in the picture. The self-timer can be used in any shooting mode.

- 1** Open the LCD monitor and press the **FUNC.** button.
- 2** Select □\* (Drive Mode) using the up or down button.





\* The current setting is displayed.

- 3** Select  or  using the left or right button and press the **FUNC.** button.

When  is selected, the shutter release will be delayed for 10 seconds, and when  is selected, the shutter release will be delayed for 2 seconds, after you press the shutter button.

## 4 Shoot the image.

- When  is selected and the shutter button is pressed fully, the self-timer lamp starts blinking and the self-timer begins to beep. The blinking gets faster two seconds before the shutter releases.
- When  is selected, the self-timer lamp blinks fast from the beginning. The shutter releases in two seconds.
- Shooting procedures are the same as for the **AUTO** mode (p. 56).

### Tip for using the self-timer

Normally the camera shakes a little when you press the shutter button.

Setting the self-timer to  delays the shutter release for two seconds and allows the camera to stop shaking, thus preventing a blurred image.



You can change the self-timer sound by changing the setting in [Selftimer Sound] in the [  (My Camera)] menu (p. 177).



## Digital Zoom

Available in the following modes.

**AUTO P Tv Av M C1 C2**     

The digital zoom can be zoomed through the following range:

4.3x, 5.3x, 6.7x, 8.2x, and 11x



- 1** Open the LCD monitor and press the **DISP.** button to turn the LCD monitor on.
- 2** In the [  (Rec.) ] menu, select  (Digital Zoom).

See *Selecting Menus and Settings* (p. 47).



- 3** Select [On] using the left or right button and press the **MENU** button.

## 4 Press the zoom lever toward and hold it.

- The lens will zoom to the maximum optical telephoto setting and stop. Release the lever and press it toward  again to further zoom the image digitally.
- Press the lever toward  to zoom back out.



The combined magnifications of the optical zoom and digital zoom are displayed.

## 5 Shoot the image.

Shooting procedures are the same as for the **AUTO** mode (p. 56).



The digital zoom cannot be used when the LCD monitor is off.





- Images become coarser the more they are digitally zoomed.
- Using digital zoom tends to increase the effect of camera shake and blurring of the image. Using a tripod is recommended.

# Continuous Shooting

Available in the following modes.

**P Tv Av M C1 C2**     

Use this mode to shoot successive frames while the shutter button is fully pressed.

	Standard Continuous Shooting	Use this mode to view the images on the LCD monitor as you shoot continuously. The shutter interval is longer in this mode than in  mode.
	High-speed Continuous Shooting	Use this mode to shoot continuously with a short shutter interval. You cannot check images while shooting continuously.

**1** Open the LCD monitor and press the **FUNC.** button.

**2** Select \*(Drive Mode) using the up or down button.



\* Current settings appear.

**3** Select  or  using the left or right button and press the **FUNC.** button.

**4 Press the shutter button halfway to lock the focus.**

**5 Press the shutter button all the way to shoot.**

- Shooting will stop when the shutter button is released.
- The shooting speed is as follows.

When  is selected: Approx. 1.6 frames per second\*

When  is selected: Approx. 2.4 frames per second\*

\* Large/Fine, LCD monitor off mode.

(These figures reflect Canon's testing standard. The actual figures will vary according to the shooting conditions and settings.)



- The shutter interval may lengthen somewhat when the internal memory becomes full.
- The built-in flash can be used, but the shutter interval will lengthen to accommodate the flash recharge time.

# Shooting-Selecting Particular Effects

Camera settings such as shutter speed and aperture can be freely changed for shooting.

See *Functions Available in Each Shooting Mode* (p. 212) at the end of this manual to find out which settings can be changed in which shooting modes.



Please see **AUTO** Mode (p. 56) for shooting procedures once you have changed a setting.

## P Program AE

Available in the following modes.

**P**

Use the program AE mode to have the camera automatically set the shutter speed and aperture value to match the brightness of the scene.

**1** Open the LCD monitor and turn the shooting mode dial to **P**.

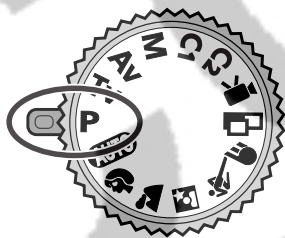



## 2 Shoot the image.



- The shutter speed and aperture value will automatically appear on the LCD monitor.
- The correct exposure has been set if the shutter speed and aperture value show in white.



- For functions available in this mode, see page 212.
- If a correct exposure cannot be obtained, the shutter speed and aperture value show in red on the LCD monitor. Use the following methods to obtain the correct exposure and make them show in white.
  - Use the flash.
  - Change the ISO speed setting.
  - Change the light metering mode.

### Differences and Similarities between the **P** and **AUTO** Modes.

- Both modes automatically select the shutter speed and aperture value.
- The following settings can be adjusted in **P** mode, but not in **AUTO** mode.
 

- Exposure Compensation	- White Balance
- ISO Speed	- Flash (Flash on)
- Photo Effects	- Continuous Shooting
- Light Metering Mode	- Manual Focus
- Auto Focus	
- For the correlation between aperture value and shutter speed, see page 90.

## Tv Setting the Shutter Speed

Available in the following modes.

**Tv**

When you set the shutter speed in the shutter-priority AE mode, the camera automatically selects an aperture value to match the brightness. Faster shutter speeds allow you to catch an instantaneous image of a moving subject while slower speeds create a flowing effect and allow you to shoot without a flash in dark areas.

- 1** Open the LCD monitor and turn the shooting mode dial to Tv.

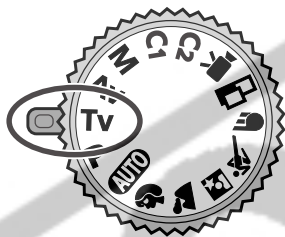

The shutter speed appears on the LCD monitor.

- 2** Select a speed using the left or right button.



### 3 Shoot the image.



The correct exposure has been set if the shutter speed and aperture value show in white.

Shooting



- If the aperture value shows in red, the image is under exposed (insufficient light) or overexposed (too much light). Adjust the shutter speed using the left and right buttons until the aperture value display turns to white.
- The nature of CCD image sensors is such that noise in the recorded image increases at slow shutter speeds. This camera, however, applies special processing to images shot at shutter speeds slower than 1.3 seconds to eliminate the noise, thereby producing high-quality images. Nevertheless, a certain amount of processing time may be required before the next image can be shot.



- For functions available in this mode, see page 212.
- Please note that camera shake becomes a factor at low shutter speeds. If the camera shake warning  appears on the LCD monitor, secure the camera to a tripod before shooting.
- The aperture value and shutter speed change according to the zoom state as follows.

	Aperture	Shutter Speed (seconds)
Wide Angle	F 2.8	to 1/1000
	F 3.2 – 4.0	to 1/1250
	F 4.5 – 8.0	to 1/2000
Telephoto	F 4.9	to 1/1000
	F 5.6 – 7.1	to 1/1250
	F 8.0	to 1/2000

- The fastest shutter speed for flash synchronization is 1/500 second. The camera automatically resets the shutter speed to 1/500 second if a faster speed is selected (p. 66).

### Shutter Speed Display

The numbers in the table below indicate the shutter speed in seconds. For slower speeds, quote marks indicate the decimal place, so that 0"3 indicates 0.3 second and 2" indicates 2 seconds.

1/2000	1/1600	1/1250	1/1000	1/800	1/640				
1/500	1/400	1/320	1/250	1/200	1/160				
1/125	1/100	1/80	1/60	1/50	1/40	1/30			
1/25	1/20	1/15	1/13	1/10	1/8	1/6	1/5		
1/4	0"3	0"4	0"5	0"6	0"8	1"	1"3	1"6	
2"	2"5	3"2	4"	5"	6"	8"	10"	13"	15"

## Av Setting the Aperture

Available in the following modes.

**Av**

The aperture adjusts the amount of light that passes through the lens.

Selecting a lower aperture value (opening the aperture) allows you to blur the background. A higher aperture value (closing it) brings the entire range from foreground to background into focus.

Shooting

- 1** Open the LCD monitor and turn the shooting mode dial to Av.



The aperture value appears on the LCD monitor.

- 2** Select a value using the left or right button.



### 3 Shoot the image.



The correct exposure has been set if the shutter speed and aperture value show in white.



- If the shutter speed shows in red on the LCD monitor, the image is under exposed (insufficient light) or overexposed (too much light). Adjust the aperture value using the left and right buttons until the shutter speed display turns white.
- Some aperture values may not be available with certain zoom positions (p. 90).



- For functions available in this mode, see page 212.
- Please note that camera shake becomes a factor at low shutter speeds. If the camera shake warning  appears on the LCD monitor, secure the camera to a tripod before shooting.
- In this mode, the shutter speed range with synchronized flash is 1/60 second to 1/500 second. The aperture value setting may therefore be changed automatically to match the synchronized flash speed even if its value was set previously.

### **Aperture Value Display**

The larger the aperture value, the smaller the lens aperture.

F2.8 F3.2 F3.5 F4.0 F4.5 F4.9 F5.0 F5.6 F6.3 F7.1 F8.0

## M Manually Setting the Shutter Speed and Aperture

Available in the following modes.

**M**

You can manually set the shutter speed and aperture to achieve a particular effect. This is convenient for shooting fireworks and other images where it is difficult to set the correct exposure automatically.

- 1** Open the LCD monitor and turn the shooting mode dial to M.

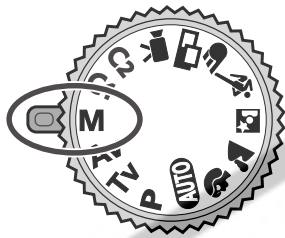

The shutter speed and aperture value appears on the LCD monitor.

- 2** Select the setting (the shutter speed or the aperture value) by pressing the **SET** button.

Pressing the **SET** button toggles the selection.

- 3** Select a shutter speed or an aperture value using the left or right button.



A green ▶ appears next to the adjustable item.





## 4 Shoot the image.

When you press the shutter button halfway, a number indicating the difference between the standard exposure\* and the selected exposure appears on the LCD monitor. If the difference is more than  $\pm 2$  stops, “-2” or “+2” appears in red.

\* The standard exposure is calculated by the AE function according to the selected metering mode.



- For functions available in this mode, see page 212.
- If you wish to change the exposure, select the shutter speed or the aperture with the **SET** button and change the value using the left or right button.
- The LCD monitor's brightness matches the selected shutter speed and aperture value. When you select a fast shutter speed or shoot a subject in a dark place and set the flash to  (Flash on with red-eye reduction) or  (Flash on) the LCD monitor will always brighten.
- When the flash is on, the output of the flash can be adjusted.
- For the correlation between aperture value and shutter speed, see page 90.

## Switching Between Autofocus Modes

Available in the following modes.

**P Tv Av M C1 C2**     

You can change the auto focus frame (AF frame) selection method. The AF frame will appear when the LCD monitor is turned on (p. 44).

<input type="checkbox"/> <input type="checkbox"/> <input type="checkbox"/> <input type="checkbox"/> <input type="checkbox"/> <input type="checkbox"/> <input type="checkbox"/> <input type="checkbox"/> <input type="checkbox"/>	On (Auto Selection)	The camera automatically selects between nine AF frames to focus according to the shooting conditions.
<input type="checkbox"/> <input type="checkbox"/> <input type="checkbox"/> <input type="checkbox"/> <input checked="" type="checkbox"/> <input type="checkbox"/> <input type="checkbox"/> <input type="checkbox"/> <input type="checkbox"/>	Off (Center)	Of nine AF frames, the middle one is selected to focus. This is convenient for making sure the focus is exactly where you want it.

indicates the AF frame which appears on the monitor

### 1 In the [ (Rec.) ] menu, select **AiAF** (AiAF).

See *Selecting Menus and Settings* (p. 47).

### 2 Select [On] or [Off] using the left or right button.



### 3 Press the **MENU** button.

You can immediately shoot the image using the selected AF frame by pressing the shutter button instead of pressing the **MENU** button.





The autofocus locks to center when using the digital zoom.

## Switching Between Light Metering Modes

Available in the following modes.

**P Tv Av M C1 C2**

You can switch between metering modes to shoot.

	Evaluative Light Metering	Appropriate for standard shooting conditions, including backlit scenes. The camera divides images into several zones for light metering. The camera evaluates complex lighting conditions, such as the position of the subject, the brightness, the background, the direct light, and the backlighting, and adjusts the settings to the correct exposure for the main subject.
	Center-Weighted Averaging	Averages the exposure from the entire image, but places more weight on the subject at the center. Use this mode when the subject is backlit or surrounded by bright light.
	Spot AE Point	Meters the area within the spot AE point frame at the center of the LCD monitor. Use this setting when you want to set the exposure on the subject in the center of the monitor.

Shooting

**1** Press the **FUNC.** button.



- 2** Select \* (Evaluative) using the up or down button.

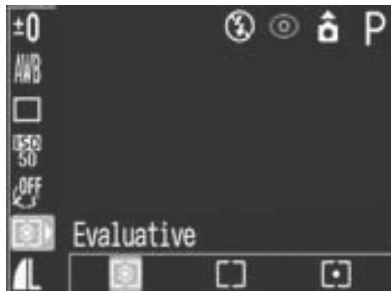

\* The current setting is displayed.

- 3** Select a light metering mode using the left or right button.

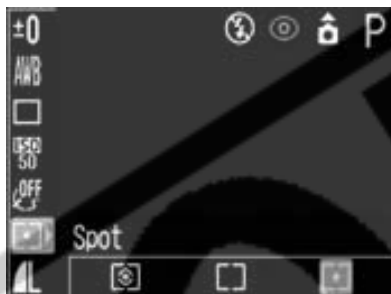

- 4** Press the **FUNC.** button.

- 5** Shoot the image.



Some settings are not available with certain Shooting modes. Please refer to *Functions Available in Each Shooting Mode* (p. 212)

# Adjusting the Exposure

Available in the following modes.



Adjust the exposure compensation setting to avoid making the subject too dark when it is backlit or shot against a bright background.

**1** Press the **FUNC.** button.



**2** Select **±0\*** (+/- (Exp.)) using the up or down button.



\* The current setting is displayed.

### 3 Select a setting using the left or right button.



- The settings can be adjusted in 1/3 stops in the range of -2EV to +2EV.
- The result of adjustment can be checked on the LCD monitor when it is on.
- You can shoot the image right after selecting settings by pressing the shutter button. This screen will appear again, once the image is shot.

### 4 Press the FUNC. button.

To cancel the exposure compensation, return the setting to  using the left or right button.

### 5 Shoot the image.

## How to adjust the exposure

This camera automatically adjusts the exposure to shoot images with the optimal brightness. However, recorded images may sometimes be brighter or darker than the actual image depending on the shooting conditions. If this happens, adjust the exposure compensation manually.



### Underexposure

The whole recorded image is dark, which makes white elements of the image appear gray. Shooting bright subjects or in backlit conditions may cause the image to be underexposed. Adjust the exposure compensation towards the + end.



### Optimal Exposure



### Overexposure







The whole recorded image is bright, which makes black elements of the image appear gray. Shooting dark subjects or in dark places may cause the image to be overexposed. Adjust the exposure compensation towards the - end.

## Adjusting the Tone (White Balance)

Available in the following modes.

**P Tv Av M C1 C2**       

When the white balance mode is set to match the light source, the camera can reproduce colors more accurately.

	Auto	The camera sets the white balance automatically according to shooting conditions.
	Day Light	Use when shooting outdoors in sunlight on a clear day.
	Cloudy	Use when shooting outdoors and the sunlight is not enough such as under cloudy skies, in shade or at dusk.
	Tungsten	For recording under tungsten and bulb-type 3-wavelength fluorescent lighting.
	Fluorescent	For recording under warm-white, cool-white or warm-white (3-wavelength) fluorescent lighting.
	Fluorescent H	For recording under daylight fluorescent, or daylight fluorescent-type 3-wavelength fluorescent lighting.
	Custom	For setting a custom value with a white sheet of paper, etc., to obtain the optimal white balance for the conditions.

**1** Press the **FUNC.** button.



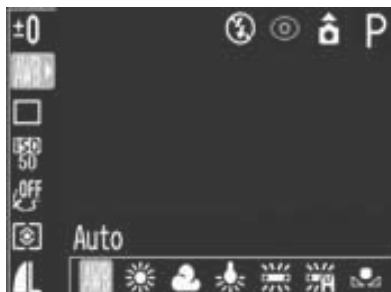

## 2 Select **AWB\*** (Auto) using the up or down button.

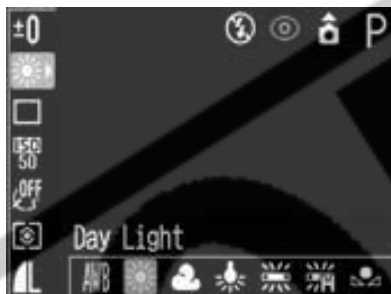

\* The current setting is displayed.

## 3 Select the desired setting using the left or right button.





- Please see the next page regarding the  custom setting.
- When the LCD monitor is on, you can check the setting on the display.
- You can shoot the image right after selecting settings by pressing the shutter button. This screen will appear again, once the image is shot.

## 4 Press the **FUNC.** button.

## 5 Shoot the image.



The white balance cannot be adjusted when the photo effect is set to  (Sepia) or  (B/W).

## ☑ Setting a Custom White Balance

You can set a custom white balance to obtain optimal settings for your particular shooting conditions by having the camera evaluate a subject such as a white piece of paper, cloth or a photo-quality gray card. In the following three situations the white balance may not be correctly adjusted in the AWB (Auto mode). Always shoot after reading and setting the white balance data in ☑ (Manual mode).

- Shooting at close distances (Macro mode)
- Shooting monotone subjects (such as the sky, sea, forest, and so on)
- Shooting under special light sources such as mercury lamps

**1** Press the FUNC. button.

**2** Select **AWB\*** (Auto) using the up or down button.

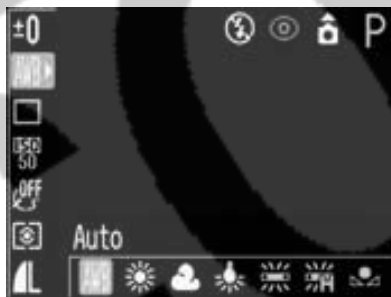

\* The current setting is displayed.

- 3 Select  (Custom) using the left or right button.



- 4 Aim the camera at the white paper, cloth or gray card and press the **SET** button.







- Aim the camera so that the white paper, cloth or gray card, completely fills the frame on the LCD monitor screen or the entire viewfinder before pressing the **SET** button. When you press the **SET** button, the camera reads the white balance data.
- You can shoot the image right after selecting settings by pressing the shutter button. This screen will appear again, once the image is shot.

- 5 Press the **FUNC.** button.

- 6 Shoot the image.









- Some settings are not available with certain Shooting modes. Please refer to *Functions Available in Each Shooting Mode* (p. 212)
- To set and use a custom white balance setting, it is advisable to select the **P** shooting mode and set the exposure compensation and flash exposure compensation to zero ( $\pm 0$ ). The correct white balance may not be obtained when the exposure is incorrect (image is completely black or white).
- It is also advisable to use the LCD monitor to compose the shot and to zoom in to the telephoto end setting. Turn the digital zoom off.
- Since the white balance data cannot be read in  mode, preset the white balance in another shooting mode first before selecting  mode.
- Shoot with the same settings as when reading the white balance data. If the settings differ, the optimal white balance may not be set.  
Especially the following should not be changed.
  - Flash  
Setting the flash to on or off is recommended. If the flash fires when reading the white balance data with the flash set to   or , make sure that you also use the flash when you shoot.
  - ISO Speed
- The custom white balance setting is not cancelled even if settings are reset to default settings (p. 178)

## Changing the Photo Effect

Available in the following modes.

**P Tv Av M C1 C2**        

You can shoot with different photo effects.

	Photo Effect Off	Records with no effect.
	Vivid	Emphasizes the contrast and color saturation to record in bold color.
	Neutral	Tones down the contrast and color saturation to record neutral hues.
	Low Sharpening	Records subjects with softened outlines.
	Sepia	Records in sepia tones.
	B/W	Records in black and white.

Shooting

- 1** Press the **FUNC.** button.
- 2** Select \* (Effect Off) using the up or down button.

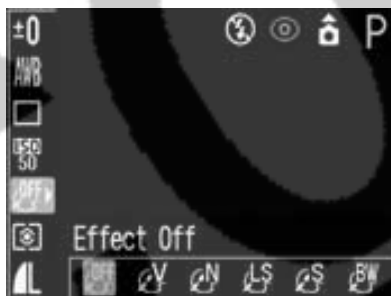

\* The current setting is displayed.

**3** Select the desired setting using the left or right button.



- If the LCD monitor is on, you can check the results by viewing the image on the LCD monitor.
- A shot can be taken immediately after by pressing the shutter button. The menu will reappear after the shot, allowing you to adjust the setting.

**4** Press the **FUNC.** button.

**5** Shoot the image.

## Changing the ISO Speed

Available in the following modes.

**P Tv Av M C1 C2**

Raise the ISO speed when you wish to reduce camera shake, when turning the flash off for use in dark conditions, or when a fast shutter speed is required.

- 1 Press the FUNC. button.**
- 2 Select \* (ISO Speed) using the up or down button.**



\* The current setting is displayed.

- 3 Select the desired setting using the left or right button.**

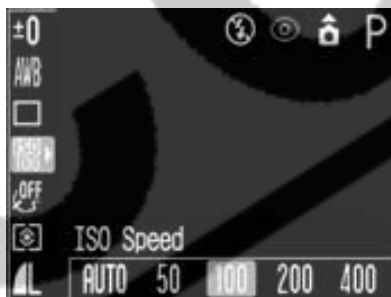

You can shoot the image right after selecting settings by pressing the shutter button. This screen will appear again, once the image is shot.

**4** Press the **FUNC.** button.

**5** Shoot the image.

### ISO speed

The ISO speed is the numeric representation of the camera's sensitivity to light. The higher the ISO speed, the higher the sensitivity. A high ISO speed allows you to shoot images in dark indoor or outdoor conditions without a flash and also helps prevent blurred images due to camera shake. This is convenient when shooting images in places where flash photography is prohibited. The ISO speed setting makes full use of the available light, resulting in images that convey the feel of the place they were shot.



ISO 50 equivalent



ISO 400 equivalent



- Higher ISO speeds increase the image noise. To take clean images, use as low an ISO speed as possible.
- The AUTO setting selects the optimal speed. It will automatically raise the speed when the light from the flash is insufficient to illuminate the subject matter.



## Adjusting the Flash Output

Available in the following modes.

**M**

In **M** mode, the flash output can be controlled in three steps, starting from FULL, when shooting. When the flash output is low, less shadow appears in the image. However, when shooting a wide scene or area, the image will likely be darker due to insufficient light. When adjusting the flash output, consider all the shooting conditions, including the distance to the subject.

Shooting

- 1** Press the **FUNC.** button.
- 2** Select  (Flash Output) using the up or down button.



- 3** Adjust the flash output using the left or right button.

You can shoot the image right after selecting settings by pressing the shutter button. This screen will appear again, once the image is shot.

- 4** Press the **FUNC.** button.
- 5** Shoot the image.

## Shooting Problem Subjects for the Autofocus

Available in the following modes.



The autofocus may not work well on the following types of subjects.

- Subjects with extremely low contrast to the surroundings
- Subjects mixing close and far objects
- Subjects with extremely bright objects at the center of the composition
- Subjects that are moving quickly

To shoot these subjects, first aim the camera at an object at a similar distance, lock the focus and recompose the image with the desired subject, or use manual focus.

### Shooting with Focus Lock

- 1** Press the **DISP.** button to turn on the LCD monitor.
- 2** Aim the **AF** frame at an object at a similar distance to the subject you wish to shoot.
- 3** Press the shutter button halfway to lock the focus.

The AE setting will also lock when you do this. The exposure may occasionally be incorrect if the difference between the two items is too great. Use AF lock when this happens.

- 4** Keep it pressed while you recompose the image and press the shutter button all the way to shoot the image.

## Shooting with AF Lock

- 1** Press the **DISP.** button to turn on the LCD monitor.

- 2** Press the shutter button halfway to lock the focus. Keep it pressed and press the **MF** button.

- The **MF** icon appears on the LCD monitor.
- The focus setting will lock even if the shutter button and the **MF** button are released.
- The manual focus setting will cancel if the **MF** button is pressed again.

- 3** Recompose the image and press the shutter button all the way to shoot the image.



---

AF lock cannot be used while the shooting mode is set to **AUTO** or .

---



- AF lock is convenient because you can let go of the shutter button to recompose the image. The focus remains locked after the shutter is released, so the same focus is used in subsequent shots.
  - When shooting through glass, get as close as possible to avoid reflection off the glass.
-

## Shooting in Manual Focus Mode

The focus can be manually set.

**1** Press the **DISP.** button to turn on the LCD monitor.

**2** Press the **MF** button until **MF** appears.



MF indicator

- The **MF** indicator appears.
- The **MF** indicator shows approximate figures. Use them as a shooting guideline only.
- In the **Tv**, **Av**, or **M** modes, pressing the **SET** button cycles the selection between the shutter speed, the aperture value, and the MF indicator. (A green ► appears next to the selected item).

**3** Use the left or right button to focus.

- Adjust the focus using the left or right button until the image appears focused on the LCD monitor.
- Pressing the **MF** button a second time cancels the manual focus mode.



**4** Shoot the image.



---

Manual focus cannot be used while the shooting mode is set to .



- 
- When the  (MF-Point Zoom) setting in the [ (Rec.)] menu is [On], the AF frame is magnified.\*
    - \* Enlargement does not occur when shooting in  or when using the digital zoom.
    - \* You can choose not to have the AF frame magnified (p. 168).
  - In manual focus, the AF frame locks on the center frame.
  - You can use manual focus in the macro focal distance 5 to 45 cm (2.0 in. to 1.5 ft.) at wide angle end and 25 to 45 cm (10 in. to 1.5 ft.) at telephoto end. In this case, the fine scale is adopted.
  - You can change the **MF** indicator displayed distance units (p. 174).
-

## C1 C2 Saving Custom Settings

Available in the following modes.

**P Tv Av M C1 C2**

You can save frequently used shooting modes and various shooting settings to the **C** (custom) mode. This camera is equipped with two modes ([**C1**] and [**C2**]), allowing you to save two types of custom settings. When necessary, you can then shoot images with previously saved settings by simply turning the mode dial to **C1** or **C2**. Settings that are usually forgotten when the shooting mode is changed or when the power is turned off (such as Macro mode or Drive mode) are also remembered.

### Settings that can be saved to the C1/C2 mode

- Shooting mode (**P**, **Tv**, **Av**, **M**)
- **P**, **Tv**, **Av** and **M** mode items that can be saved (p. 212)
- Shooting menu settings
- Zoom location
- Manual Focus location

**1** Turn the mode dial to **P**, **Tv**, **Av** or **M**.

**2** Set the settings you wish to save.

### 3 In the [ ] (Rec.) menu, select [C] (Save Settings).

See *Selecting Menus and Settings* (p. 47).

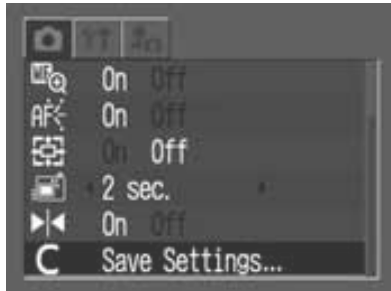

### 4 Select [C1] or [C2] and press the SET button.

Selects a save destination (**C1** or **C2**).

### 5 Press the MENU button.



- When you wish to re-save partially modified settings (except shooting mode) that were previously saved in the **C1** / **C2** mode, select **C1** / **C2** in Step 1.
- The settings do not influence other shooting modes.
- Saved settings can be reset (p. 178).

## Setting the Auto Rotate Function

This camera is equipped with an Intelligent Orientation sensor that detects the orientation of an image shot with the camera held vertically and automatically rotates it to the correct viewing orientation in the display. You can set this function on/off.



### **1** In the [**⏏**] (Set up)] menu, select **⏏** (Auto Rotate).

See *Selecting Menus and Settings* (p. 47).



### **2** Select [**On**] and press the **MENU** button.

When this function is on, an icon showing the orientation of the camera appears at the upper right corner of the LCD monitor display (when information display is on).

	Normal
	Right end down
	Left end down





- This function may not operate correctly when the camera is pointed straight up or down. Check that the arrow is pointing in the right direction and if it is not, then set the Auto Rotate function to [Off].
- Even if the Auto Rotate function is set to [On], the orientation of images downloaded to a computer will depend upon the software used to download the images.



- When the camera is held vertically to shoot, the Intelligent Orientation sensor judges the upper end to be “up” and the lower end to be “down”. It then regulates the optimal white balance and exposure for vertical photography. This function operates regardless of the on/off status of the Auto Rotate function.
- When changing the camera’s orientation between the horizontal and vertical positions, you may hear noise coming from the orientation detection mechanism. This is not a malfunction.

## Resetting the File Numbers

You can select the way file numbers are assigned.

On	The file numbers are reset to the start (100-0001) each time a new CF card is inserted. New images recorded on CF cards with existing files are assigned the next available number.
Off	The file number of the last image to be shot is memorized so that images recorded to a new CF card start from the next number.

- 1** In the [  (Set up)] menu, select  (File No. Reset).

See *Selecting Menus and Settings* (p. 47).



- 2** Select [On] or [Off] using the left or right button.
- 3** Press the **MENU** button.



Setting the [File No. Reset] to [Off] is useful for avoiding file name duplication when images are downloaded to a computer.

### About File and Folder Numbers

Images are assigned file numbers from 0001 to 9900, and folders are assigned folder numbers from 100 to 998 (Folder numbers cannot contain 99 in the last two digits).

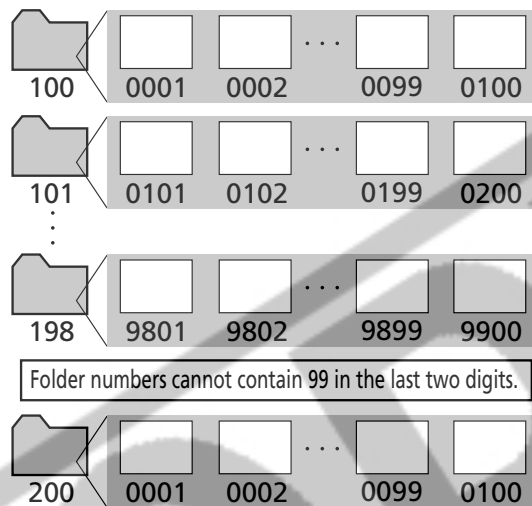

### Folder File Capacity

Each folder usually contains up to 100 images. However, since images shot in Continuous mode and Stitch Assist mode are always saved into the same folder, a folder may contain more than 100 images. The number of images may also exceed 100 if a folder contains images copied from a computer or images shot with other cameras.

Please note, however, that the images in folders containing 2001 or more images cannot be played back in this camera.

# Playback

## Displaying Images Individually

You can view the recorded images on the LCD monitor.

### 1 Open the LCD monitor.

The position of the LCD can be adjusted to suit your viewing position.

### 2 Slide the mode switch to .

The last recorded image appears (single image playback).



### 3 Move between images using the left or right button.

Use the left button to move to the previous image and the right button to move to the next. Holding the left or right button moves more rapidly between images, but the images will not appear as clearly.



- Press the **DISP.** button to show the data for the displayed image (p. 37).
- Press the  button to quickly delete the displayed image (p. 136).

## 🔍 Magnifying Images

Images can be magnified up to approximately 10 times.

**1** Slide the mode switch to .

**2** Press the zoom lever toward .



— Approximate position

- You can move around the magnified image using the left, right, up or down button.
- Hold the **SET** button down and press the zoom lever toward  to cycle through each setting, approximately 2.5 times, to approximately 5 times and 10 times.

## Canceling the Magnified Display

**1** Press the zoom lever toward .



Movie frames and index playback images cannot be magnified.



You can magnify an image while it is displayed on the LCD monitor in Shooting mode immediately after the image is shot (p. 58).

## Viewing Images in Sets of Nine (Index Playback)

Up to nine images can be viewed at once in index playback.

**1** Slide the mode switch to .

**2** Press the zoom lever toward .

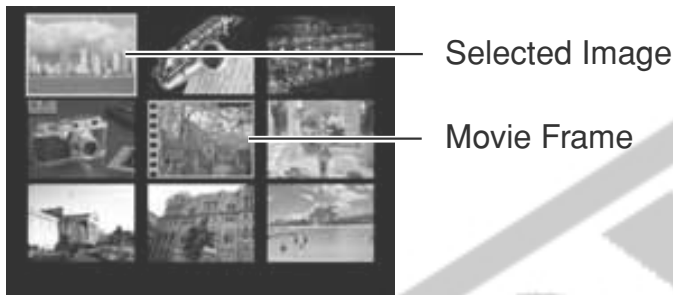

Nine images appear at once (index playback).

**3** Change the image selection using the left, right, up or down button.

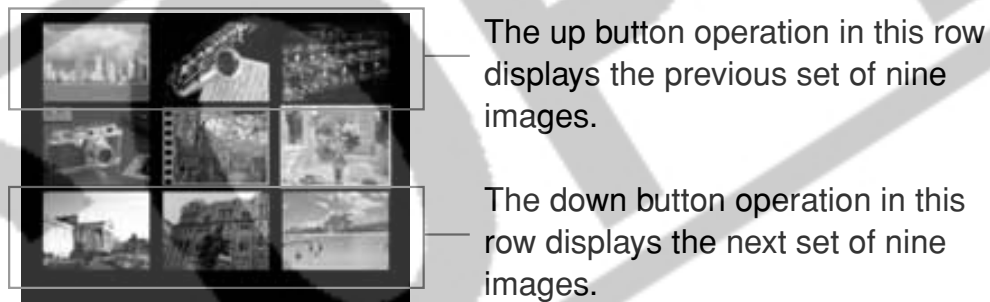

**4** Press the zoom lever toward .

Index playback cancels and the display reverts to single image playback.



Press the **DISP.** button to show the data for the displayed image (p. 37).

## Jumping Between Images

The display can be advanced or set back 9 images when in index playback.

**1** Press the zoom lever once toward  while in index playback (p. 124).

**2** Change the displayed images.

- Jump 9 images back or forward using the left and right buttons.
- Holding down the **SET** button and pressing the left or right button jumps to the first set or the last set of 9 images.



Jump bar

**3** Press the zoom lever toward .

- The jump bar disappears and the camera returns to index playback.
- If you press the zoom lever once more toward , the camera returns to single image playback.

## Viewing Movies

You can playback the images shot in  mode.

### 1 Slide the mode switch to .

Movies cannot be viewed in index playback.

### 2 Select a movie using the left or right button and press the **SET** button.



- A movie displays with the **SET**  icon on it.
- The movie playback panel appears.

### 3 Select (Play) using the left or right button and press the **SET** button.



Movie playback panel

Volume

- The movie and sound will play.
- You can adjust the volume using the up or down button.
- When a movie has finished playing, it will display the last frame. If the **SET** button is pressed in this state, the camera will revert to the movie playback panel. If the **SET** button is pressed again, the movie will start playing from the first frame.







## Pausing and Resuming Play

Press the **SET** button to pause the movie. Press it again to resume.

## Fast Forwarding/Rewinding

Select one of the following operations using the left or right button and press the **SET** button.

-  (Exit): Return to single image playback
-  (First Frame): Show first frame
-  (Previous Frame): Show previous frame (Rewinds if the **SET** button is held down)
-  (Next Frame): Show next frame (Fast forwards if the **SET** button is held down)
-  (Last Frame): Show last frame

Playback, Erasing



You may experience frame dropping and audio breakup when playing back a movie on a computer with insufficient system resources.



- The volume can also be adjusted in the Set up menu (p. 172).
- Please adjust the audio sound level on the TV when viewing movies on a TV.

## Editing Movies

You can delete unwanted portions from the first or second half of a movie clip.

### 1 Select the movie you wish to edit and press the **SET** button.

See *Viewing Movies* (p. 126).

### 2 Select (Edit) using the left or right button and press the **SET** button.





The movie editing panel and the movie editing bar appear.

### 3 Select an editing method using the up or down button.



Movie edit panel

Movie edit bar

-  (Cut beginning): Deletes frames in the first half of the movie
-  (Cut end): Deletes frames in the second half of the movie
-  (Exit): Reverts to the movie playback panel

**4** Select the range you wish to edit using the left or right button.



**5** Select **▶** (Play) using the up or down button and press the **SET** button.

- The temporarily edited movie will start playing.
- The movie will stop if you press the **SET** button while it is playing.

**6** Select **⏮** (Save) using the up or down button and press the **SET** button.



When **⏮** is selected, the edited movie is not saved and the camera reverts to playback.

## 7 Select [Overwrite] or [New File] using the left or right button and press the SET button.



- [Overwrite] : Saves the edited movie under the same file name as the original movie. The original data is deleted.
- [New File] : Saves the edited movie under a new file name. The original data is not deleted.
- When there is not enough space left on the CF card, only the overwrite function is available.



- Protected movies cannot be edited.
- It may take approximately 3 minutes to save an edited movie. If the batteries run out of charge partway through, edited movie clips cannot be saved. When editing movies, use fully charged NiMH batteries, unused alkaline batteries or the separately sold AC Adapter Kit ACK600 (p. 184).



- Movies with an original length of 2 seconds or more can be edited.
- The minimum length for movie clips is 1 second.

## Rotating Images in the Display

Images can be rotated 90° and 270° clockwise on the LCD monitor.



0° (Original)

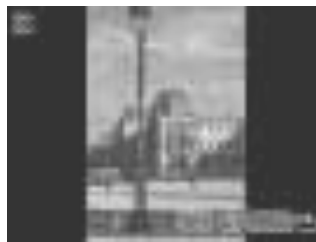

90°



270°

**1** In the [  (Play)] menu, select  (Rotate).

See *Selecting Menus and Settings* (p. 47).

**2** Select an image you want to rotate using the left or right button and press the **SET** button.

The image cycles to the next orientation (90° → 270° → original) each time the **SET** button is pressed.

**3** Press the **MENU** button.

The Play menu appears again. Press the **MENU** button again to close the menu.





- Movie images cannot be rotated.
- When images are downloaded to a computer, the orientation of images rotated by the camera will depend upon the software used to download the images.



Rotated images can be magnified (p. 123).

## Attaching Sound Memos to Images

In playback mode (including single image playback, index playback and magnifying playback) you can attach sound memos (up to 60 seconds) to an image. The sound data is saved in WAVE format.

- 1** In the [  (Play)] menu, Select  (Sound Memo).

See *Selecting Menus and Settings* (p. 47).



 appears.

- 2** Select the image to which you wish to add a sound memo using the left or right button, then press the SET button.





Sound memo panel

The sound memo panel appears.

- 3** Select  (Record) using the left or right button, then press the SET button.

- The recording starts and the elapsed time is displayed. Speak towards the microphone of the camera.
- To stop recording, press the **SET** button. To restart recording press the **SET** button again.
- You can add as many sound memos as you like until their total time for one image reaches 60 seconds.

### Playing back the Sound memos

- Select  (Play) in step 2 on the previous page. Images with sound memos are displayed with the  mark (simple display or detailed display).
- To stop playback, press the **SET** button. To resume playback, press the **SET** button again. You can adjust the volume using the up or down button.

### Erasing the Sound Memos

Select  (Erase) in step 2 on the previous page.

### Ending the Sound Memos Settings

Press the **MENU** button.



- You cannot attach sound memos to movies.
- You cannot record or playback sound memos for images that already have an incompatible sound file attached. If you attempt to record or play such images the “Incompatible Wave format” message will display. Incompatible sound files can be deleted with this camera.
- Sound memos for protected images cannot be erased. (p. 135).



The volume can be adjusted in the Setup menu (p. 172).

## Auto Play

Use this feature to automatically play back all of the images in the CF card (Auto Play). The LCD monitor displays each image for approximately 3 seconds.

### **1** In the [ (Play)] menu, select (Auto Play).

- See *Selecting Menus and Settings* (p. 47).
- Once you have selected it, Auto Play starts.
- As with the single image display mode, pressing the left or right button during auto play will advance through the images more rapidly.

### **Pausing and Resuming Auto Play**

You can pause Auto Play at any time by pressing the **SET** button. You can then restart it by pressing the **SET** button again.

### **Stopping Auto Play**

To stop Auto Play, press the **MENU** button.



- The display interval may vary for some images.
- Movies play for the length of time that they were recorded.
- The power saving function is disabled during Auto Play (p. 32).



## Protecting Images

You can protect important images from accidental erasure.

### 1 In the [ (Play)] menu, select (Protect).

See *Selecting Menus and Settings* (p. 47).

### 2 Select an image you want to protect using the left or right button and press the SET button.



Protected Icon

- The  icon appears on protected images.
- To remove the protection, press the SET button again (in protection mode).
- You can make the selection of images easier by toggling between single playback and index playback. (p. 124)

### 3 Press the MENU button.

The camera returns to the menu screen. Press the MENU button again to exit the menu screen.



Please note that formatting (initializing) a CF card erases all data, including protected images (p. 138). Please check the contents of a CF card before formatting it.

# Erasing



Please note that erased images cannot be recovered.  
Exercise caution before erasing a file.

## Erasing Images Individually

- 1** Select the image you wish to erase using the left or right button and press the  button.

A confirmation screen appears.



- 2** Select [Erase] using the left or right button and press the **SET** button.

To cancel instead of erasing, select [Cancel] and press the **SET** button.



Protected images cannot be erased with the erase function (p. 135).

## Erasing All Images

- 1** In the [  (Play)] menu, select  (Erase all) and press the **SET** button.

A confirmation screen appears.

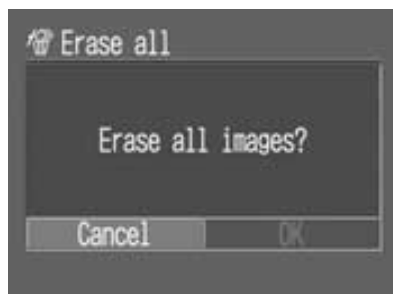

- 2** Select [OK] using the left or right button and press the **SET** button.

To cancel instead of erasing, select [Cancel] and press the **SET** button.

Playback, Erasing



Protected images cannot be erased with the erase function (p. 135).

## Formatting a CF Card

You should always format a new CF card or one from which you wish to erase all images and other data.



Please note that formatting (initializing) a CF card erases all data, including protected images and other file types. Please check the contents of the CF card before formatting it.

- 1** In the [  (Set up)] menu, select  (Format) and press the **SET** button.



- 2** Select [OK] using the left or right button and press the **SET** button.



- To cancel formatting instead, select [Cancel] and press the **SET** button.
- The capacity of the CF card displayed after formatting will be less than the rated capacity of the CF card. This is not a malfunction of the CF card or camera.



- 
- If the camera does not work properly, the inserted CF card may be malfunctioning. Reformatting the CF card may solve the problem.
  - When a non-Canon brand CF card is malfunctioning, reformatting it may solve the problem.
  - CF cards formatted in another camera, computer or peripheral device may not operate correctly. When that happens, reformat the CF card with this camera. If formatting in the camera does not work properly, turn the camera off and remove the CF card. Then try again.
-

# Print Settings

## About Printing

You can easily print images stored in the CF card by connecting the camera to a direct print compatible printer\*<sup>1</sup> with a cable and operating the camera buttons. In addition, you can specify the images on your CF card you want to print and how many copies you want (DPOF\*<sup>2</sup> Print Settings), and then take the CF card to a participating photo lab to have them printed out later.

\*<sup>1</sup> The direct print  icon appears for *Canon Direct Print* compatible CP series printers.

\*<sup>2</sup> Digital Print Order Format

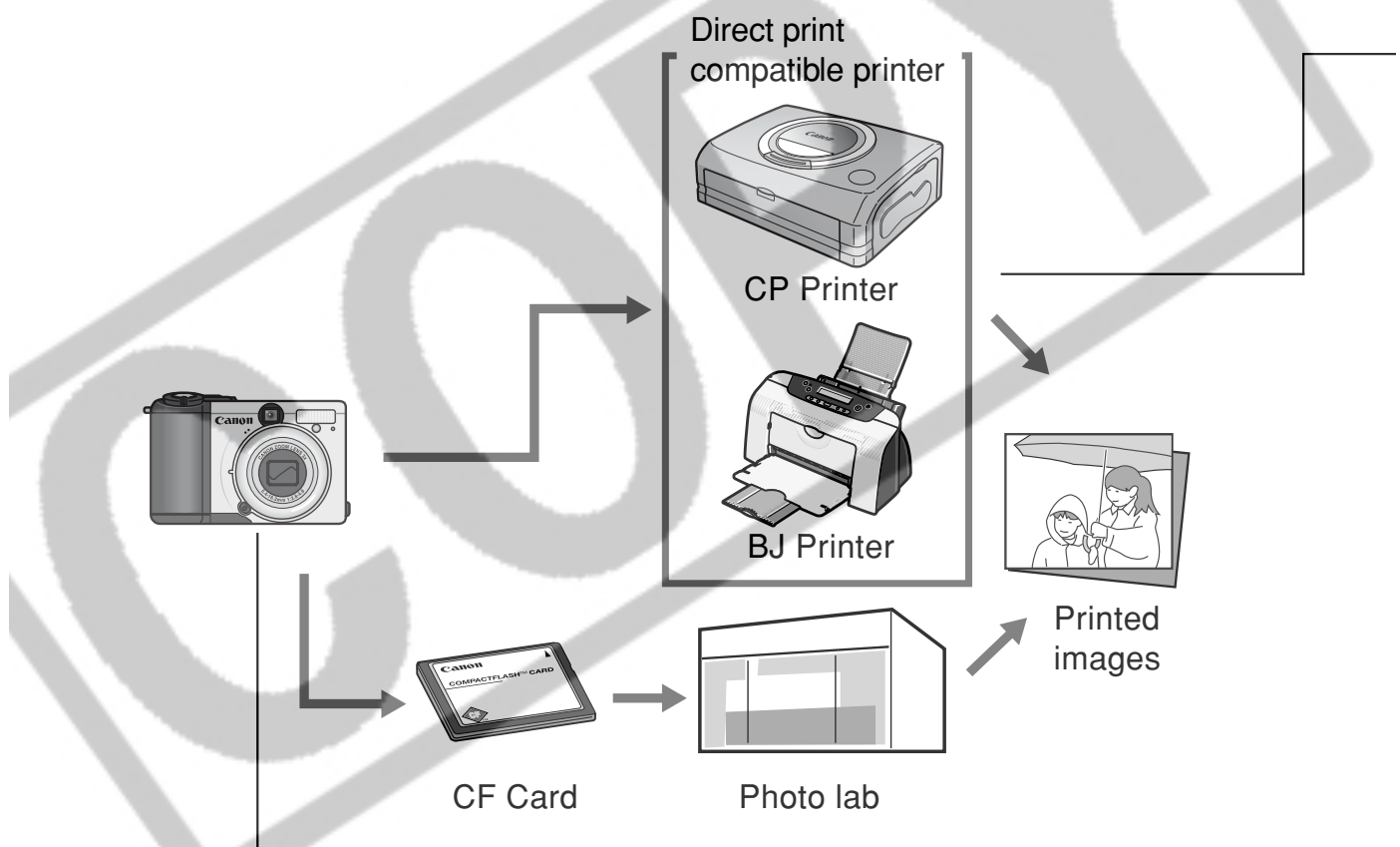

Please refer to the *System Map* supplied with your camera for direct print compatible printer (CP series or Bubble Jet printers) information.

### **Print for Direct Print Compatible Printing**

- Connect the camera to the printer
- Set various print settings (except DPOF print settings)
- Print



For printing instructions, see the *Direct Print User Guide*.

### **DPOF Print Settings**

- Select the image you want to print (p. 142)
- Select how many copies you want (p. 143)



- Select the print style (p. 145)
  - Standard/Index/Both
  - Date On/Off
  - File Numbers On/Off

For printing instructions, see the *Direct Print User Guide*.

### **DPOF Transfer Settings**

- Select the image you want to download to a computer (p. 148)



## Print Settings (DPOF Print Settings)

You can select images on a CF card for printing and specify the number of print copies in advance using the camera. This is extremely convenient for sending the images to a photo developing service, or for printing on a *Canon Direct Print* compatible CP printer or Bubble Jet printer, or on a *PictBridge* compliant printer.



- The  mark appears on images that have had print marks set by another DPOF camera. These settings will be overwritten by any print marks set by your camera.
- The output of some digital printers or photo labs may not reflect your specified print settings.
- Print settings cannot be set for movie images.

## Selecting Images for Printing

**1** In the [  (Play) ] menu, select  (Print Order) and press the **SET** button.

See *Selecting Menus and Settings* (p. 47).

**2** Select [Order] using the left or right button and press the **SET** button.





### 3 Select images for printing.

#### Single Images

- When the print type (p. 145) is set to [Standard] or [Both], select an image using the left or right button. You can set the number of copies (up to 99) to be printed using the up or down button.
- When the print type (p. 145) is set to [Index], select an image using the left or right button and mark or remove marks from images using the up or down button.
- You can use the same procedures to select images in index playback (three images).

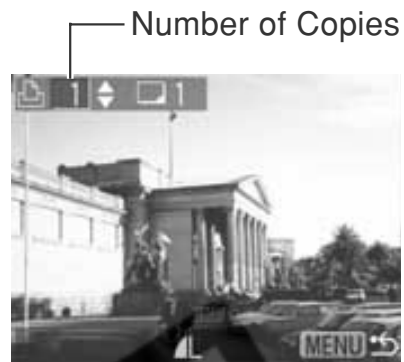

#### All the Images on a CF Card

- Switch to index playback (three images).
- You can set one copy of each image to print by pressing the **SET** button, then selecting [Mark all] using the up or down button, and pressing the **SET** button again.
- When the print type is set to [Standard] or [Both], the setting for the number of print copies can be changed for each image. When [Index] is selected, the print settings can be deleted. For the instructions on changing settings, please reread Step 3 from the beginning.
- You can cancel all the settings by selecting [Clear all].









## 4 Press the MENU button.





- Images are printed in order from oldest to newest by the shooting date.
- A maximum of 998 images can be marked per CF card.
- Press the zoom lever in step 3 to switch between single and 3-image index playback for selecting an image.
- When [Print Type] is set to [Both], the number of copies can be set. When it is set to [Index], the number of copies cannot be set (only one copy will be printed).
- Print settings can also be assigned to images with the supplied software programs on a computer.

## Setting the Print Style

The following print settings can be selected.



 Print Type	 Standard	Prints one image per page
	 Index	Prints index prints (multiple reduced-size images per page)
	  Both	Prints the images in both the standard and index formats
 Date		Adds the date to the print
 File No.		Adds the file number to the print

- 1** In the [  (Play) ] menu, select  (Print Order) and press the SET button.

See *Selecting Menus and Settings* (p. 47).

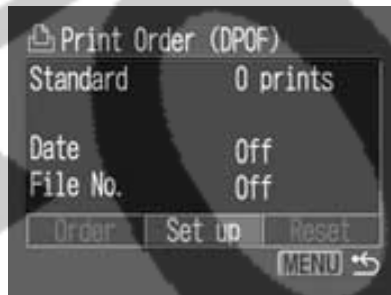
- 2** Select [Set up] using the left or right button and press the SET button.



- 3** Select  (Print Type),  (Date) or  (File No.) using the up or down button.

## 4 Select a setting using the left or right button.



 **(Print Type)**  
Select [Standard], [Index], or [Both].



 **(Date)**  
Select [On] or [Off].



 **(File No.)**  
Select [On] or [Off].

## 5 Press the MENU button.

The set up menu will close and the Print Order menu will reappear.



- When [Print Type] is set to [Index], the [Date] and [File No.] cannot be set to [On].
- If [Print Type] is set to [Both], both [Date] and [File No.] can be set to [On], however, only the file number is printed for the index print.



The date prints as the date and time in the format specified in the Date/Time menu (p. 26).

## Resetting the Print Settings

All the print settings can be reset to their defaults easily. The print type will be reset to [Standard] and the date and file number options set to [Off].

- 1** In the [  (Play)] menu, select  (Print Order) and press the **SET** button.

See *Selecting Menus and Settings* (p. 47).

- 2** Select [Reset] using the left or right button and press the **SET** button.

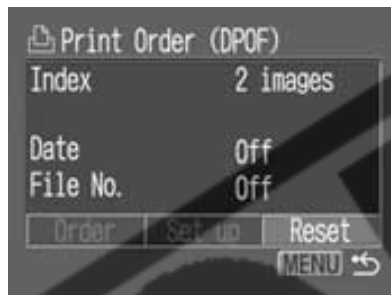

- 3** Select [OK] using the left or right button and press the **SET** button.

If you decide you don't want to reset the settings, select [Cancel] and press the **SET** button.

## Image Transfer Settings (DPOF Transfer Order)

You can mark the images you wish to transfer from the camera to a computer.

These settings are compatible with DPOF (Digital Print Order Format).



The  mark will display on images that have had transfer marks set by another DPOF-compliant camera. These settings will be overwritten by any marks set by your camera.

## Selecting Images for Transferring

- 1** In the [  (Play) ] menu, select  (Transfer Order) and press the **SET** button.

See *Selecting Menus and Settings* (p. 47).

- 2** Select [Order] using the left or right button and press the **SET** button.



Pressing [Reset] cancels the transfer settings for all images on the CF card.

### 3 Select images for transferring.

#### Single Images

- Select an image using the left or right button and mark or remove marks from images using the up or down button.
- You can use the same procedure when you switch to index playback (a set of three images) by pressing the zoom lever toward .



#### All the Images on a CF Card

- Switch to index playback (a set of three images) by pressing the zoom lever toward .
- Press the **SET** button, select [Mark all] using the up or down button and press the **SET** button again. (If you select [Clear all] instead of [Mark all], you can remove marks from all the images.)
- You can mark or remove a mark from each image after marking or removing marks from all the images.



### 4 Press the **MENU** button.

The selection mode will turn off and the Transfer Order menu will reappear.



- Images are transferred in order from oldest to newest by the shooting date.
- A maximum of 998 images can be marked per CF card.

# Downloading Images to a Computer

Download images taken with the camera to a computer in one of the following ways:

- **Connect the camera to a computer with the USB cable**

You can then download images directly from the camera to a computer.

- **Directly from the CF card**

Using a laptop computer or a card reader, you can download images directly from the CF card.

## Connecting the Camera to a Computer Via the USB Cable

After the software is installed, you can use it to easily download images and print them or send them by email.

### IMPORTANT

You must install the software and driver bundled on the supplied Canon Digital Camera Solution Disk onto your computer if you are using any of the following operation systems:

Windows 98 (including Second Edition)/Windows 2000/Windows Me  
Mac OS 9.0 - 9.2



The camera will not operate correctly if you connect it to your computer before installing the driver and software. If this happens, please refer to the *Troubleshooting* section of the *Software Starter Guide*.



# 1 Install the driver and the software applications bundled on the Canon Digital Camera Solution Disk.

Please see the *Software Starter Guide* for information on system requirements and installation instructions.

# 2 Connect the supplied USB interface cable to the computer's USB port and the camera's DIGITAL terminal.

- You do not need to turn off the computer or camera when making a USB connection.
- Please refer to your computer manual for information regarding the location of the USB port.

# 3 Slide the mode switch to . Press the ON/OFF button until the power indicator lights.

- A image appears on the LCD monitor.
- When the connection between the camera and a computer completes, the LCD monitor turns off and the power indicator lights green.

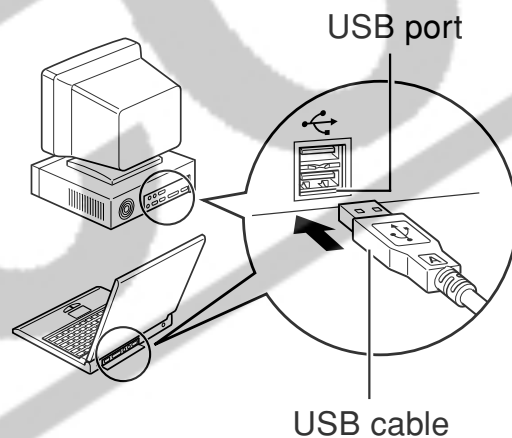

## DIGITAL terminal

1. Open the terminal cover with your fingernail.
2. Insert the connector until it clicks.

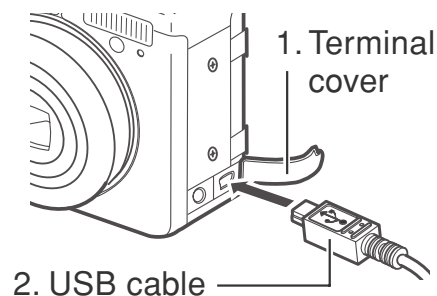

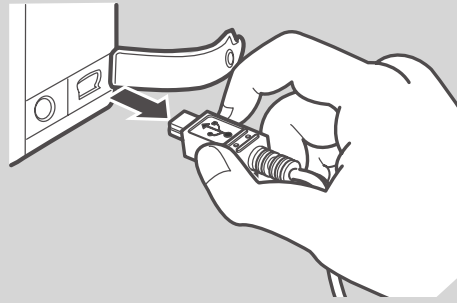

To disconnect the cable from the camera: Hold the cable connector firmly at both sides and pull it straight out.

**For information about what to do after making the connection, please see the *Software Starter Guide*.**

## Downloading Images without Installing the Software (Windows XP and Mac OS X (10.1 or 10.2) only)

If you are using Windows XP or Mac OS X (10.1 or 10.2), you can use the software distributed with these operating systems to download images (JPEG format only) without installing the software bundled on the Canon Digital Camera Solution Disk. This is useful for downloading images to a computer in which the software is not installed.

However, please note that there are certain limitations to downloading images with this method. For more details, please refer to the supplied *For Windows® XP and Mac OS X Users Leaflet*.

- 1** Connect the supplied USB interface cable to the computer's USB port and the camera's DIGITAL terminal. (Refer to step 2 on page 151)
- 2** Follow the onscreen instructions to download the images.



- It is recommended to power the camera with the separately sold AC Adapter Kit ACK600 when connected to a computer (p. 184).
- All procedures performed with a connection to a USB 2.0 compliant board are not guaranteed.

## Downloading Directly from a CF Card

- 1 Eject the CF card from the camera, and insert it into a CF card reader connected to the computer.**

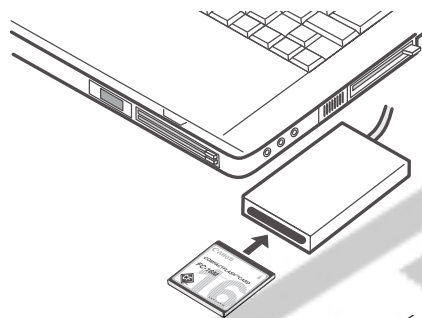

- If you are using a PC card reader or a PC card slot, first insert the CF card into a PC card adapter (sold separately).

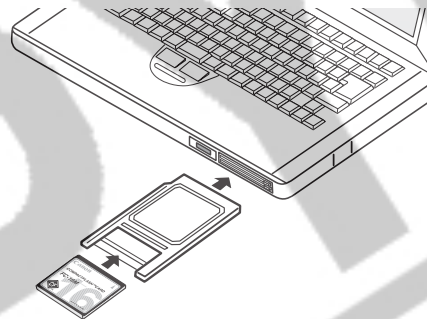

- 2 Double-click the icon of the drive with the CF card.**

Depending on the operating system, a window opens automatically.

- 3 Copy images from the card into a folder of your choice on the hard disk.**

The images are stored in the [xxxCANON] folders located under the [DCIM] folder (where xxx is a three-digit number from 100 to 998 (p. 121)).

# Viewing Images on a TV Set

A video-compatible television connected via the supplied AV cable AVC-DC100 can be used to view images as you shoot or play them back.

## 1 Turn off the camera (p. 31).

Turn off the television also.

## 2 Attach the AV Cable to the terminal on the camera.

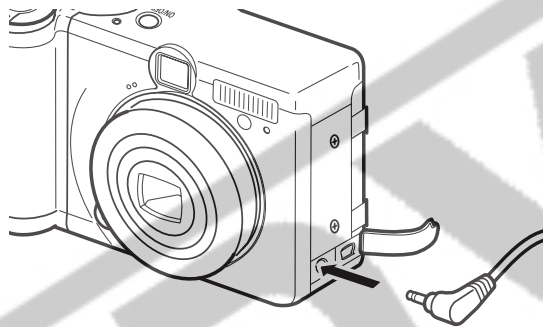

## 3 Plug the other ends of the AV cable to the video in and audio in jacks on the TV.

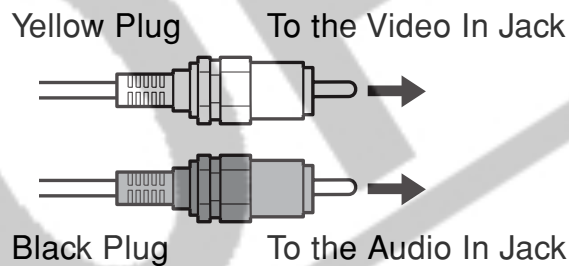

## 4 Turn on the TV and switch it to Video mode.

## 5 Turn on the camera in Shooting mode or Playback mode (p. 31).

- The image will appear on the TV. Shoot or playback images as usual.
- If the images are not appearing on the TV when shooting, press the **DISP.** button.



- No image will appear on the LCD monitor when the camera is connected to a TV monitor.
- The video output signal can be switched (NTSC or PAL) to accommodate different regional standards (p. 175). The default setting will vary between regions.  
NTSC: Japan, U.S.A., Canada, Taiwan, etc.  
PAL: Europe, Asia (excluding Taiwan), Oceania, etc.  
If an incorrect video system is set, the output image will not display properly.
- If the TV is a stereo model, you can plug the audio plug into either the left or right Audio In jack. Please refer to the TV's manual for details.
- A TV set cannot be used in  mode.

# Customizing the Camera (My Camera Settings)

My Camera allows you to customize the start-up image and start-up, shutter, operation and self-timer sounds. Each menu item has three choices.

e.g. Start-up image



[ 1 ]

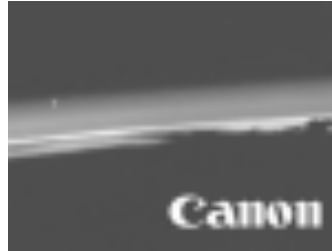

[ 2 ]



[ 3 ]

As default settings, My Camera setting [ 2 ] has a science fiction theme and My Camera setting [ 3 ] has an animal theme.

## Changing My Camera Settings

- 1** Turn on the camera (p. 31).
- 2** Press the **MENU** button.



The [  (Rec.) ] or [  (Play) ] menu appears.

- 3** Select the [  (My Camera)] menu using the left or right button.



- 4** Select a menu item using the up or down button.

- 5** Select setting content using the left or right button.









- 6** Press the **MENU** button.

- Pressing the **MENU** button closes the menu and makes the settings take effect.
- In Shooting mode, the menu can be closed by pressing the shutter button halfway.







- If you select [Theme] in Step 4, you can select a consistent theme for each of the My Camera settings.
- If  (Mute) in the [] (Set up) menu is set to [On], the beep does not sound even if each sound item such as [Start-up Sound], [Operation Sound], [Selftimer Sound] or [Shutter Sound] in the [] (My Camera) menu is set to [, , ] (On) (p. 172).



## Registering My Camera Settings

Images recorded onto the CF card and newly recorded sounds can be added as My Camera settings to the [  ] and [  ] menu items. You can also use the supplied software to upload your computer's images and sounds to the camera.

The following menu items can be saved to the camera.

- Start-up Image
- Start-up Sound
- Operation Sound
- Selftimer Sound
- Shutter Sound

## Registering CF Card Images and Sounds

**1** Turn on the camera (p. 31).

**2** Slide the mode switch to .

The camera switches to Playback mode.

**3** Press the **MENU** button.

The [  ] (Play) menu appears.

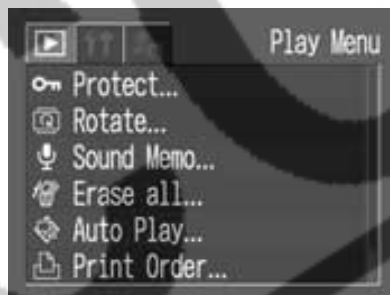

- 4** Select the [  (My Camera)] menu using the left or right button.



- 5** Select the menu item you wish to register using the up or down button.

- 6** Select  or  using the left or right button.

  appears.



- 7** Press the **DISP.** button.

An image appears.



[Start-up Image] → Step 8a, 9a  
[Start-up Sound], [Shutter Sound], [Operation Sound],  
[Selftimer Sound] → Step 8b, 9b

**8a** Select the image you wish to register using the left or right button.



**9a** Press the **SET** button.

**8b** Select  (Record) using the left or right button and press the **SET** button.



- Recording starts.
  - Recording stops when the set amount of time has passed.
- Start-up Sound: 1 second, Operation Sound: 0.3 second, Selftimer Sound: 2 seconds, Shutter Sound: 0.3 second.

**9b** Select  (Register) using the left or right button.

**10** Select [OK] using the left or right button and press the **SET** button.



- Sounds recorded with the movie (p. 76) and sound memo (p. 132) functions cannot be added as My Camera settings.
- When you register new My Camera settings, the previously registered settings are erased.

## File Format of My Camera Settings

My Camera settings should conform to the below file formats. However, CF card images shot with this camera can be registered as My Camera settings regardless of the below formats.

- Start-up Image
  - Image recording format      JPEG (Base line JPEG)
  - Sampling rate                    4:2:0 or 4:2:2
  - Image size                        320 x 240 pixels
  - File capacity                      20 KB or less

- Start-up Sound, Operation Sound, Selftimer Sound and Shutter Sound

- Recording format            WAVE (monaural)
- Quantization bit            8 bit
- Sampling frequency        11.025 kHz and 8.000 kHz
- Recording time

	11.025 kHz	8.000 kHz
Start-up Sound	1.0 sec. or less	1.3 sec. or less
Operation Sound	0.3 sec. or less	0.4 sec. or less
Selftimer Sound	2.0 sec. or less	2.0 sec. or less
Shutter Sound	0.3 sec. or less	0.4 sec. or less

Any file format other than those described above cannot be used with this camera.











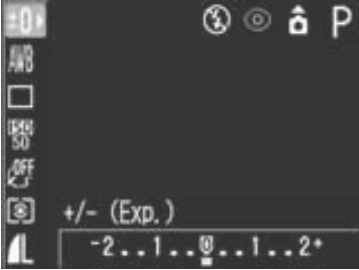







An example of this function is to record “Say cheese” as the self-timer sound so the camera will playback this sound 2 seconds before the photo is taken. You could also record cheerful music to bring out the natural smiles of your subjects, or so they can strike a pose fitting the music. In these ways you can customize your camera by creating and adding new My Camera settings.

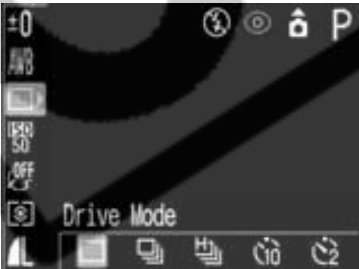

See the supplied *Software Starter Guide* for more information on creating and adding to the My Camera Settings files.

# List of Menu Options and Messages

## FUNC. Menu



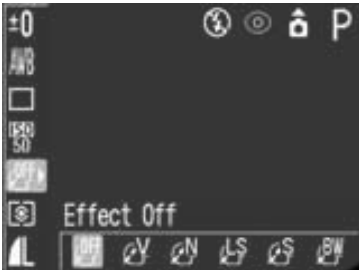



\* Default setting

Item/ Menu Screen	Setting Content	Reference Page
<p>Exposure Compensation</p> 	<p>Sets the exposure compensation. -2 ... 0* ... +2</p>	<p>99</p>
<p>Flash Output</p> 	<p>Adjusts the flash output when the mode dial is set to <b>M</b>.</p> <p>  FULL (1/3 power)*   FULL (2/3 power)   FULL (Full power)         </p>	<p>111</p>
<p>White Balance</p> 	<p>Sets the white balance.</p> <ul style="list-style-type: none"> <li>•  (Auto)*</li> <li>•  (Day Light)</li> <li>•  (Cloudy)</li> <li>•  (Tungsten)</li> <li>•  (Fluorescent)</li> <li>•  (Fluorescent H)</li> <li>•  (Custom)</li> </ul>	<p>102</p>
<p>Drive Mode</p> 	<p>Sets Continuous shooting settings and the self-timer.</p> <ul style="list-style-type: none"> <li>•  (Standard Shooting)*</li> <li>•  (Continuous Shooting)</li> <li>•  (High-speed Continuous Shooting)</li> <li>•  (Self-timer, 10 sec.)</li> <li>•  (Self-timer, 2 sec.)</li> </ul>	<p>80 84</p>

Item/ Menu Screen	Setting Content	Reference Page
<p>ISO Speed</p> 	<p>Sets the sensitivity at which images are recorded.</p> <ul style="list-style-type: none"> <li>• AUTO</li> <li>• 50*</li> <li>• 100</li> <li>• 200</li> <li>• 400</li> </ul>	109
<p>Photo Effect</p> 	<p>Switches between photo effects.</p> <ul style="list-style-type: none"> <li>• OFF (Effect Off)*</li> <li>• Vivid</li> <li>• Neutral</li> <li>• Low Sharpening</li> <li>• Sepia</li> <li>• B/W</li> </ul>	107
<p>Light Metering System</p> 	<p>Switches between light metering modes.</p> <ul style="list-style-type: none"> <li>• Evaluative*</li> <li>• Center Weighted Avg.)</li> <li>• Spot</li> </ul>	97
<p>Resolution (Stills)</p> 	<p>Sets the number of pixels used for images.</p> <ul style="list-style-type: none"> <li>• L Large (2272 x 1704 pixels)*</li> <li>• M1 Medium 1 (1600 x 1200 pixels)</li> <li>• M2 Medium 2 (1024 x 768 pixels)</li> <li>• S Small (640 x 480 pixels)</li> </ul>	60





\* Default setting

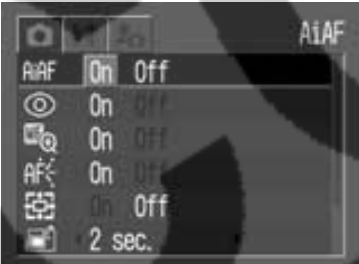

Item/ Menu Screen	Setting Content	Reference Page
Resolution (Movies) 	Sets the number of pixels used for movies. <ul style="list-style-type: none"> <li>•  (320 x 240 pixels)*</li> <li>•  (160 x 120 pixels)</li> </ul>	60
Compression 	Sets the relative compression ratio used for images. <ul style="list-style-type: none"> <li>•  Superfine</li> <li>•  Fine*</li> <li>•  Normal</li> </ul>	60

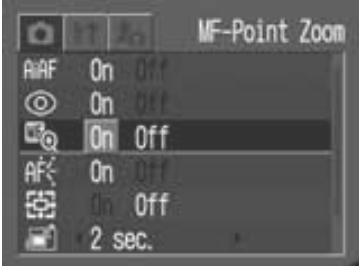
## Rec. Menu

Item/ Menu Screen	Setting Content	Reference Page
	Sets the AiAF to on (the camera automatically selects the AF frame when taking a picture) or off (AF frame is set to the center frame). <ul style="list-style-type: none"> <li>• On*</li> <li>• Off</li> </ul>	96



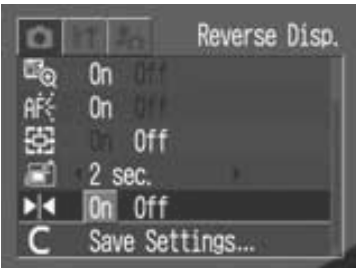



Item/ Menu Screen	Setting Content	Reference Page
 <p>Red-eye</p>	<p>Sets whether or not the red-eye reduction lamp fires.</p> <ul style="list-style-type: none"> <li>• On*</li> <li>• Off</li> </ul>	65
 <p>MF-Point Zoom</p>	<p>Sets whether or not the focusing point is magnified when using the manual focus.</p> <ul style="list-style-type: none"> <li>• On*</li> <li>• Off</li> </ul>	115
 <p>AF-assist Beam</p>	<p>Sets the output of the AF-assist beam according to shooting conditions when using the auto focus.</p> <ul style="list-style-type: none"> <li>• On*</li> <li>• Off</li> </ul>	46
 <p>Digital Zoom</p>	<p>Sets whether or not the digital zoom combines with the optical zoom to zoom images.</p> <ul style="list-style-type: none"> <li>• On</li> <li>• Off*</li> </ul>	82

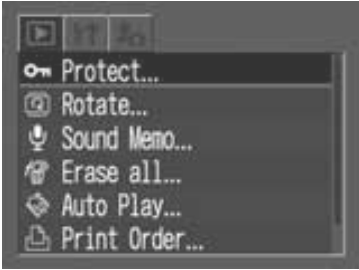

\* Default setting

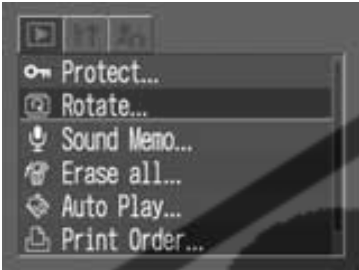
Item/ Menu Screen	Setting Content	Reference Page
 <p>Review</p>	<p>Sets the duration images display on the LCD monitor after the shutter button is released.</p> <ul style="list-style-type: none"> <li>• Off</li> <li>• 2 sec.* to 10 sec.</li> </ul>	59
 <p>Reverse Disp.</p>	<p>Sets whether or not the images are reversed.</p> <ul style="list-style-type: none"> <li>• On*</li> <li>• Off</li> </ul>	35
 <p>Save Settings</p>	<p>Saves settings selected in the  and <b>FUNC.</b> menus to the <b>C1</b> or <b>C2</b> shooting mode shown on the shooting mode dial.</p>	116

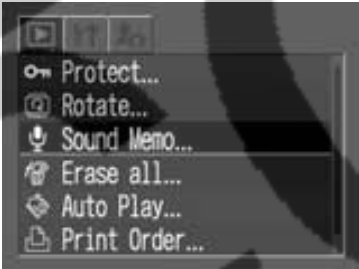

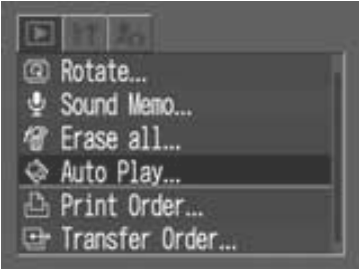

# Play Menu

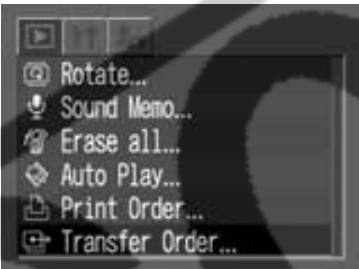
\* Default setting









Item/ Menu Screen	Setting Content	Reference Page
<p> Protect</p> 	<p>Protects images from accidental erasure.</p>	<p>135</p>
<p> Rotate</p> 	<p>Rotates images 90 or 270 degrees clockwise in the display.</p>	<p>131</p>
<p> Sound Memo</p> 	<p>Adds sound memos to images.</p>	<p>132</p>
<p> Erase all</p> 	<p>Erases all images from a CF card (excluding protected images).</p>	<p>137</p>



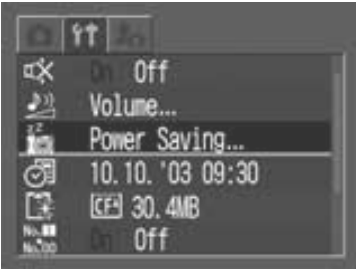

Item/ Menu Screen	Setting Content	Reference Page
 <p>Auto Play</p>	Plays images automatically one after the other.	134
 <p>Print Order</p>	Sets which images and how many copies will be printed on a direct print compatible printer or at a photo lab.	142
 <p>Transfer Order</p>	Sets in advance the images that will be transferred to a computer by the camera.	148

# Set up Menu

Item/ Menu Screen	Setting Content	Reference Page
	<p>Sets whether or not the beep sounds when the shutter button is pressed or when a menu operation is performed. For details, see “How the Mute setting in the [M] (Set up) menu and each sound setting in the [C] (My Camera) menu are related” on page 177.</p> <ul style="list-style-type: none"> <li>• On</li> <li>• Off *</li> </ul> <p>Note that the error warning sound beeps even when the Mute setting is [On].</p>	—
	<p>Adjusts the volume of the start-up sound, operation sound, self-timer sound, shutter sound, or playback sound. The volume cannot be adjusted if [Mute] is set to [On].</p> <ul style="list-style-type: none"> <li>• □□□□ (Off)</li> <li>• ■□□□ (1)</li> <li>• ■■□□ (2)*</li> <li>• ■■■□ (3)</li> <li>• ■■■■ (4)</li> <li>• ■■■■ (5)</li> </ul>	—
	<p><b>Start-up Vol.</b> Adjusts the sound volume when the camera powers up.</p>	31
	<p><b>Operation Vol.</b> Adjusts the sound volume when any button except the shutter button is operated.</p>	—
	<p><b>Selftimer Vol.</b> Adjusts the sound volume that beeps for two seconds before the shutter is released.</p>	80



\* Default setting

Item/ Menu Screen	Setting Content	Reference Page
	 Shutter Volume Adjusts the sound volume when the shutter button is pressed all the way. There is no shutter sound in Movie mode.	44
	 Playback Vol. Adjusts the sound volume when a movie or a sound memo is played.	126 132
	 Power Saving Sets the Auto Power Down and Display Off settings.	32
	 Auto Power Down Sets whether or not the camera automatically powers down after a specified period of time elapses without camera operation. <ul style="list-style-type: none"> <li>• On*</li> <li>• Off</li> </ul>	32
	 Display Off Specifies a period of time before the LCD monitor turns off when no camera operation is performed. <ul style="list-style-type: none"> <li>• 10 sec. • 1 min.*</li> <li>• 20 sec. • 2 min.</li> <li>• 30 sec. • 3 min.</li> </ul>	32
	 Date/Time Sets the date, time and date format.	26



Item/ Menu Screen	Setting Content	Reference Page
	Formats (initializes) a CF card	138
	Sets how file numbers are assigned to images when new CF cards are inserted. <ul style="list-style-type: none"> <li>• On</li> <li>• Off*</li> </ul>	120
	Sets whether or not images shot with the camera held vertically are automatically rotated in the display. <ul style="list-style-type: none"> <li>• On*</li> <li>• Off</li> </ul>	118
	Sets the format of the MF indicator's displayed distance units. <ul style="list-style-type: none"> <li>• m/cm*</li> <li>• ft/in</li> </ul>	114

















\* Default setting



Item/ Menu Screen	Setting Content	Reference Page
<p data-bbox="277 338 472 380">☰ Language</p> 	<p data-bbox="667 338 1235 495">Sets the language used in the menus and messages on the LCD monitor. The menu may appear differently in some regions.</p> <ul data-bbox="667 495 1105 716" style="list-style-type: none"> <li>• English*</li> <li>• Deutsch</li> <li>• Français</li> <li>• Nederlands</li> <li>• Dansk</li> <li>• Suomi</li> <li>• Italiano</li> <li>• Norsk</li> <li>• Svenska</li> <li>• Español</li> <li>• Chinese</li> <li>• Japanese</li> </ul> <p data-bbox="667 716 1219 831">You can change the language during image playback by holding the <b>SET</b> button and pressing the <b>MENU</b> button.</p>	29
<p data-bbox="277 831 521 873">NTSC PAL Video System</p> 	<p data-bbox="667 831 1219 873">Sets the video output signal standard.</p> <ul data-bbox="667 873 797 947" style="list-style-type: none"> <li>• NTSC*</li> <li>• PAL</li> </ul>	155

## My Camera Menu

You can select the theme, start-up image and sound, shutter sound, operation sound and selftimer sound used on this camera. These are called My Camera settings. You can also customize the [  ] and [  ] options for each item with images recorded on the CF card and newly recorded sounds or by using the supplied software. See the *Software Starter Guide* for details.

\* Default setting

Item/ Menu Screen	Setting Content	Reference Page
	Selects a common theme for each My Camera settings item. *1 <ul style="list-style-type: none"> <li>•  (Off)</li> <li>•  *</li> <li>•  </li> <li>•  </li> </ul>	157
	Sets the start-up image when you turn on the camera. <ul style="list-style-type: none"> <li>•  (Off)</li> <li>•  *</li> <li>•  </li> <li>•  </li> </ul>	157
	Sets the start-up sound when you turn on the camera. *1 <ul style="list-style-type: none"> <li>•  (Off)</li> <li>•  *</li> <li>•  </li> <li>•  </li> </ul>	157

Item/ Menu Screen	Setting Content	Reference Page
	<p>Sets the sound when any button other than the shutter button is pressed.*<sup>1</sup></p> <ul style="list-style-type: none"> <li>• [Mute] (Off)</li> <li>• [1] *</li> <li>• [2]</li> <li>• [3]</li> </ul>	157
	<p>Sets the sound informing you that the photo will be taken in 2 seconds.*<sup>1</sup></p> <ul style="list-style-type: none"> <li>• [Mute] (Off)</li> <li>• [1] *</li> <li>• [2]</li> <li>• [3]</li> </ul>	157
	<p>Sets the shutter sound when the shutter button is pressed all the way. There is no shutter sound in Movie mode.</p> <ul style="list-style-type: none"> <li>• [Mute] (Off)</li> <li>• [1] *</li> <li>• [2]</li> <li>• [3]</li> </ul>	157

**\*1 How the [Mute] setting in the [  (Set up)] menu and each sound setting in the [  (My Camera)] menu are related**

To turn off the the start-up beep, the shutter sound, operation sound, and self-timer sound all at one time, set [Mute] in the [  (Set up)] menu to [On]. This setting overrides each setting for those sounds. Note that the error warning sound beeps even when the [Mute] setting is [On].

## Resetting the Settings to Default

You can reset all the menu and button operation settings to their defaults.

### **1** Turn on the camera.

The mode dial can be turned to any setting.

### **2** Press the **MENU** button for longer than 5 seconds.

The message “Reset settings to default?” appears on the LCD monitor.

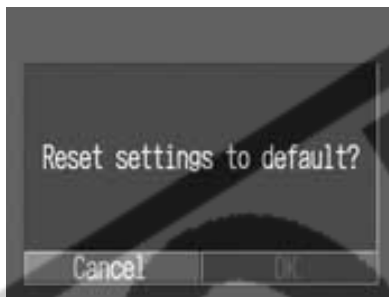

### **3** Select [OK] using the left and right buttons, then press the **SET** button.

- The screen below appears while resetting. The normal screen resumes when resetting is complete.



- To cancel resetting, select [Cancel] instead of [OK].



- 
- Following data do not reset to default.
    - Date/Time, Language, and Video system set in the [F1] (Set up) menu (p. 173, 175)
    - The custom white balance (p. 104)
    - Newly registered My Camera settings (p. 160)
  - When the camera is connected to a computer or a printer, this operation does not work.
-

## List of Messages

The following messages may appear on the LCD monitor. For messages that may appear when the camera is connected to a printer, see the *Direct Print User Guide*.

<b>Busy...:</b>	Image is being recorded to, or read from, CF card. Resetting settings to default.
<b>No Memory card:</b>	You attempted to shoot or playback images without a CF card installed.
<b>Cannot record!:</b>	You attempted to shoot an image without a CF card installed.
<b>Memory card error:</b>	CF card has experienced an anomaly.
<b>Memory card full:</b>	CF card stores images to its full capacity. No space is left to save more images or print settings.
<b>Naming error!:</b>	The file could not be created because there is a file with the same name as the directory that the camera is attempting to create, or the highest possible file number has already been reached. In the Rec. menu, please set [File No.] Reset to [On]. After you save all the images you wish to retain onto a computer, format the CF card (p. 138). Please note that formatting will erase all the existing images and other data.
<b>Change the batteries:</b>	Battery charge is insufficient to operate the camera. Replace with new AA-size alkaline batteries or fully charged batteries (Be sure to replace all batteries at the same time.).
<b>No image:</b>	No images recorded on CF card.
<b>Image too large:</b>	You attempted to playback an image larger than 4064 x 3048 pixels.
<b>Incompatible JPEG format:</b>	You attempted to playback an incompatible JPEG file.

<b>Corrupted data:</b>	You attempted to playback an image with corrupted data.
<b>RAW:</b>	You attempted to playback an image recorded in an incompatible RAW format.
<b>Unidentified Image:</b>	You attempted to playback an image that was recorded in a special format (proprietary format used by the camera of another manufacturer, or a movie that was taken with another camera.).
<b>Cannot magnify!:</b>	You attempted to magnify a movie, an image that was photographed with another camera, recorded in a different format, or edited on a computer.
<b>Cannot rotate:</b>	You attempted to rotate a movie, an image that was photographed with another camera, recorded in a different format, or edited on a computer.
<b>Incompatible Wave format:</b>	Cannot attach sound memo to the image because the image has some sound file recorded in an inappropriate format.
<b>Cannot register this image!:</b>	You attempted to register an image recorded with another camera as a start-up image.
<b>Protected!:</b>	You attempted to erase a protected image.
<b>Too many marks:</b>	Too many images have been marked for printing, transferring, or auto playing. Cannot process any more.
<b>Unselectable image:</b>	You attempted to set the print settings for a non-JPEG file.
<b>Exx:</b>	(xx: number) Camera malfunction. Turn the power off and then back on, then shoot and playback. A problem exists if the error code reappears. Note the number and contact our Canon Customer Support Help Desk. If an error code displays directly after taking a picture, the shot may not have been recorded. Check image in playback mode.

# Appendix

## Using the Battery Kits (Sold Separately)

### Using Rechargeable Batteries (Battery and Charger Kit CBK100)

Included are the battery charger and four rechargeable AA-size NiMH (nickel metal hydride) batteries. Charge batteries as shown below.

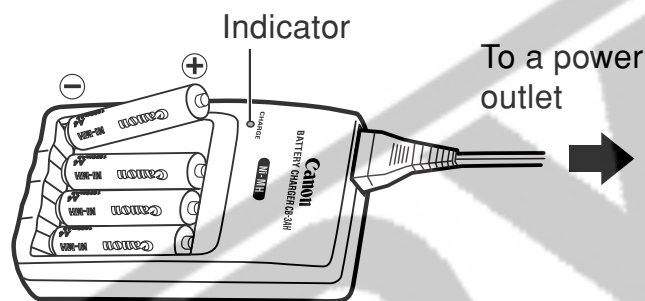

- The indicator blinks while charging, then remains lit when charging is finished.



- This charger can be used only to charge Canon AA-size NiMH batteries. Please do not attempt to charge any other type of batteries with this charger.
- Never mix new batteries together with batteries that have been used in other devices.
- When recharging batteries from the camera, always recharge all four of them at the same time.
- All batteries you place in the charger should be at approximately the same charge state, and should have been purchased at the same time. Don't mix batteries with different purchase dates or different charge states.
- Do not attempt to recharge fully charged batteries, as doing so may reduce or impair battery performance. Also, do not charge batteries for more than 24 consecutive hours.
- Do not recharge batteries in enclosed areas that tend to retain heat.



- Repeatedly recharging batteries before they become fully depleted may cause batteries to lose capacity. Do not recharge the batteries until the LCD monitor displays the “Change the batteries” message.
- Wipe the battery terminals well with a dry cloth in the following situations, as the terminals may be soiled with oil from one’s skin or other dirt:
  - If the battery usage time has considerably diminished
  - If the number of recordable images has considerably diminished
  - When charging the batteries (insert and remove the batteries two or three times before charging)
  - When charging completes in a matter of a few minutes (the battery charger indicator remains lit)
- You may not be able to fully charge the batteries due to their specifications right after purchase or after long periods of non-use. If this happens, use the batteries until their charge is depleted before charging them again. After doing this several times, battery performance will be restored.
- Since storing a fully charged battery pack for long periods of time (about 1 year) can shorten its lifecycle or affect performance, you are recommended to use the battery pack in the camera until it is completely discharged and to store it at normal temperature (23° C/73° F) or less. If you do not use the battery pack for long periods of time, charge it fully and discharge it fully in the camera at least once a year before returning it to storage.
- If battery usage time is considerably low despite their terminals’ being wiped and the battery charger’s indicator remaining lit, it is possible that the batteries have reached the end of their lifespan. Switch to different, unused batteries. If you are purchasing new batteries, look for Canon’s AA-size NiMH batteries (four-piece set).
- Leaving batteries in the camera or charger may damage it causing battery leakage. Remove batteries from the camera or charger and store in a dry cool location when not in use.



- It takes approximately 220 minutes for the charger to fully recharge the batteries (as determined by testing at Canon facilities). Please do not charge batteries in areas where the temperature is outside the range of 0 to 35 °C (32 to 95 °F).
- Charging time varies according to ambient temperature and to the batteries' initial charge state.

### Using the AC Adapter Kit ACK600

This separately sold adapter kit allows you to operate the camera continuously without worrying about having to stop and replace the batteries. Use of the kit is recommended when you are planning long sessions with the camera, and whenever you connect the camera to a computer.



Be sure that the camera is turned off before connecting or disconnecting the compact power adapter.

**1** Connect the power cord to the compact power adapter, and then plug the other end into the power outlet.

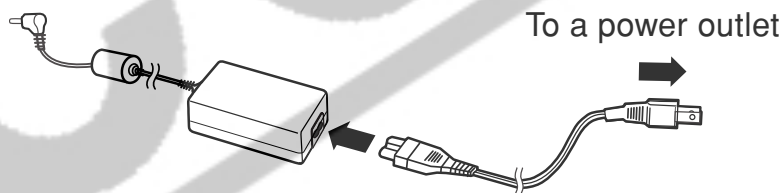

- 2** Open the **DIGITAL** terminal cover, and connect the adapter's DC plug into the camera's DC IN terminal.

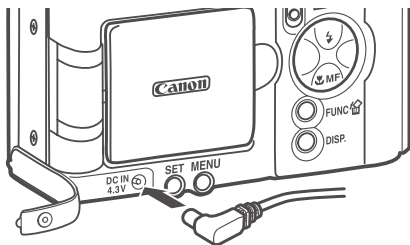

Please unplug the adapter from the power outlet when you have finished using the camera.



Please do not attempt to use any AC adapter other than AC Adapter Kit ACK600 with your camera. Use of a different adapter may result in damage to the camera or to the adapter.

## Using the Lenses and Lens Adapter (Sold Separately)

The camera supports use of the separately sold Wide Converter WC-DC52A, Tele-converter TC-DC52 and Close-up Lens 250D (52 mm). In order to attach any of these lenses, you also need to use the separately sold Conversion Lens Adapter LA-DC52D.



- When attaching the wide converter, tele-converter or close-up lens, be sure to screw it on securely. If they come loose they may fall from the lens adapter, posing risk of injury from shattered glass.
- Never look into the sun or into strong light through the wide converter, tele-converter or the close-up lens, as this can result in blindness or impairment of vision.



- If you use the flash when shooting with the wide converter, the outer area of the recorded image (especially lower right corner) will come out relatively dark.
- When using the tele-converter, please set the focal length to the telephoto end. At other zoom settings, the image will appear as if its corners have been cut off.
- When using the wide converter, please set the camera to the wide angle end.
- The wide converter blocks part of the view through the viewfinder.

## Wide Converter WC-DC52

Use this converter for taking wide-angle shots. The wide converter changes the focal length of the camera body's lens by a factor of 0.7 (The thread diameter is 52 mm.).



## Tele-converter TC-DC52A

This 52 mm-threaded diameter magnifying conversion lens is for taking telephoto shots. The lens changes the focal length of the camera body's lens by a factor of 1.75x.



## Close-Up Lens 250D (52 mm)

This lens makes it easy to take macro shots. With the camera set to Macro mode, you can use this option to shoot subjects that are 8 to 11 cm (3.1 to 4.3 in.) away from the front of the lens (telephoto end).





It is not possible to attach a lens hood or filter to the wide converter or tele-converter.

## Shooting Ranges in Macro Mode

	Distance between Front of Lens and Subject	Field Coverage
Telephoto end	8 cm (3.1 in.)	45 × 34 mm (1.8 × 1.3 in.)
	11 cm (4.3 in.)	55 × 41 mm (2.2 × 1.6 in.)
Wide-angle end	4 cm (1.6 in.)	48 × 36 mm (1.9 × 1.4 in.)
	16 cm (6.3 in.)	148 × 111 mm (5.8 × 4.4 in.)

## Conversion Lens Adapter LA-DC52D (52 mm)

This separately sold adapter is required for attaching the wide converter, tele-converter and close-up lens (all sold separately).



## Attaching a Lens

- 1** Be sure that the camera is turned off.

- 2** Press the ring release button and hold it down, and turn the ring in the direction of the arrow.

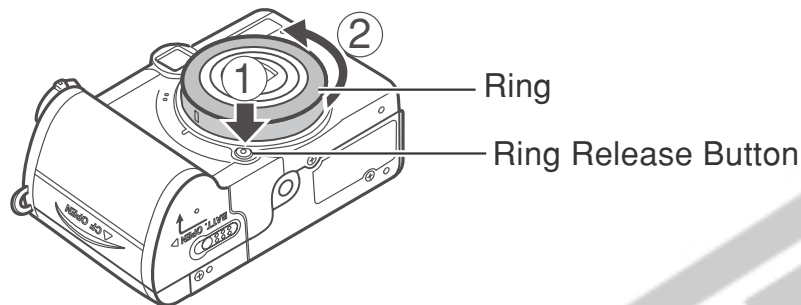

- 3** When the **■** marks on the ring and the **●** mark on the camera are aligned, lift off the ring.

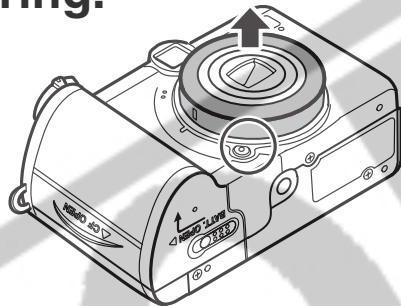

- 4** Align the **●** marks on the Conversion Lens Adapter and the **●** mark on the camera, and turn the adapter in the direction of the arrows as far as the **□** mark on the camera.

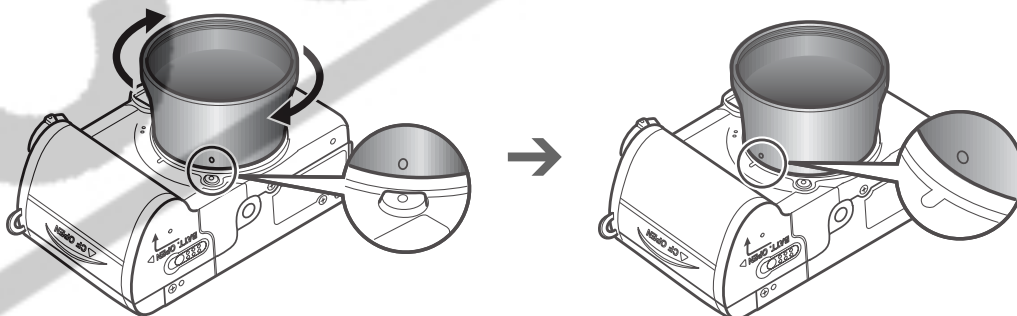

## 5 Set the lens on the adapter, and attach it securely by turning it in the indicated direction.

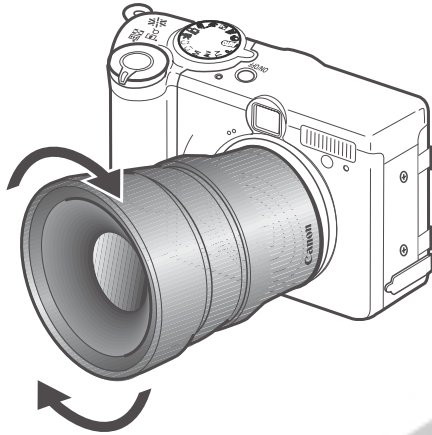

- Completely remove all dust and dirt from conversion lenses with a lens blower brush before use. The camera may focus on any dirt that remains.
- Exercise due caution when handling the lenses since it is easy to dirty them with finger prints.
- Be careful not to drop the camera or adapter when removing the ring.
- When shooting with these attachments, please use the LCD monitor to compose your shots. The attachments block part of the view through the viewfinder, and the area shown in the viewfinder does not match the area of the shot that is actually recorded.
- You should not shoot images in  mode when using these attachments. Although it is possible to select this mode at the camera, the PhotoStitch software will not be able to stitch the images together at the computer.



## Camera Care and Maintenance

Use the following procedures to clean the camera body, lens, viewfinder, LCD monitor and other parts.

Camera Body	Wipe the camera body with a soft cloth or eyeglass lens wiper.
Lens	First use a lens blower brush to remove dust and dirt, then remove any remaining dirt by wiping the lens lightly with a soft cloth. <ul style="list-style-type: none"><li>• Never use synthetic cleansers on the camera body or lens. If dirt remains, contact the closest Canon Customer Support Help Desk as listed on the separate Canon Customer Support leaflet.</li></ul>
Viewfinder, LCD monitor	Use a lens blower brush to remove dust and dirt. If necessary, gently wipe the viewfinder and LCD monitor with a soft cloth or an eyeglass lens wiper to remove stubborn dirt. <ul style="list-style-type: none"><li>• Never rub or press forcefully on the LCD monitor. These actions may damage it or lead to other problems.</li></ul>



Never use water, paint thinner, benzene, or detergents to clean the camera, as these may cause damage or deformation.

# Troubleshooting

Problem	Cause	Solution
Camera will not operate	Power is not turned on	Press the ON/OFF button for a few moments.
	CF card slot cover or battery cover opened	Confirm that the CF card slot cover or battery cover is securely closed.
	Batteries are loaded in the wrong direction.	Reload the batteries in the correct direction.
	Insufficient battery voltage	<ul style="list-style-type: none"> <li>• Replace with unused alkaline or fully recharged batteries (four AA-size batteries.)</li> <li>• Use an AC adapter.</li> </ul>
	Batteries are not the right type.	Use only unused AA-size alkaline batteries or Canon AA-size NiMH batteries. (For information about alkaline batteries, see <i>Proper Battery Handling</i> (p. 21))
	Poor contact between camera and battery terminals	Wipe the terminals with a clean, dry cloth.
Camera will not record	The mode switch is set to  (Playback).	Switch the camera to Shooting mode.



<b>Problem</b>	<b>Cause</b>	<b>Solution</b>
Camera will not record	Flash is charging	Wait until the orange indicator stops blinking and lights steadily, signaling that the flash is charged, then press the shutter button.
	CF card full	<ul style="list-style-type: none"> <li>• Insert a new CF card.</li> <li>• If required, download the images to a computer and erase them from the CF card to make space.</li> </ul>
	CF card not formatted correctly	<ul style="list-style-type: none"> <li>• Format CF card. ➔ See <i>Formatting a CF card</i> (p. 138).</li> <li>• If reformatting doesn't work, the CF card logic circuits may be damaged. Contact the nearest Canon Customer Support Help Desk.</li> </ul>
Lens will not retract	Battery cover or CF card slot cover opened with camera on	Close the CF card slot cover or battery cover, then turn off the camera.
	CF card slot cover or battery cover opened while camera was recording to CF card (warning signal)	Close the covers, and then use the ON/OFF button to turn the power off correctly.

<b>Problem</b>	<b>Cause</b>	<b>Solution</b>
Battery pack consumed quickly	Batteries are not the right type.	Use only unused AA-size alkaline batteries or Canon AA-size NiMH batteries. (For information about alkaline batteries, see <i>Proper Battery Handling</i> (p. 21))
	The batteries are cold.	Battery performance deteriorates at low temperatures. If shooting in a cold area, keep the batteries warm (by placing them in an inner pocket, etc.) until ready to use them.
	Battery terminals are dirty.	Wipe them well with a dry cloth before use.
	The batteries have not been used for over a year.	If batteries are rechargeable: Performance should return to normal after several charging cycles.
	If rechargeable batteries: The batteries have lost their effectiveness.	Replace all 4 batteries with new ones.
If using rechargeable batteries: Batteries do not charge.	Batteries were placed in the charger in the wrong direction.	Put batteries back into the charger in the correct direction.

<b>Problem</b>	<b>Cause</b>	<b>Solution</b>
If using rechargeable batteries: Batteries do not charge.	Poor electrical contact.	<ul style="list-style-type: none"> <li>• Be sure to set batteries firmly into the charger.</li> <li>• Be sure that the power cord is firmly connected to the charger, and is firmly plugged in to the power outlet.</li> </ul>
	Battery terminals are dirty.	Wipe them well with a dry cloth before charging.
	Battery life exceeded.	Replace all 4 batteries with new ones.
Shots are blurry or unfocused.	The camera was moving when you took the shot.	Hold the camera steady when shooting.
	Autofocus function hampered by obstruction to AF-assist beam.	Be careful not to block the AF-assist beam with your finger or other items.
	The AF-assist beam has been set to [Off] through the menu.	Set the AF-assist beam to [On] (p. 168).

<b>Problem</b>	<b>Cause</b>	<b>Solution</b>
Shots are blurry or unfocused.	The subject was outside the range over which the camera can focus.	<ul style="list-style-type: none"> <li>• Ensure that there is at least 45 cm (1.5 ft.) between the camera lens and subject.</li> <li>• Use the macro mode to shoot close-ups between 5 to 45 cm (2.0 in. to 1.5 ft.) from the lens when set to wide angle and between 25 to 45 cm (10 in. to 1.5 ft.) when set to telephoto.</li> </ul>
	Subject is hard to focus on.	Use the focus lock or the manual focus to shoot the image. → See <i>Shooting Problem Subjects for the Autofocus</i> (p. 112)
The subject comes out underexposed (too dark).	Insufficient light for shooting.	Set the flash on.
	The subject is darker than the surroundings.	Set exposure compensation to a positive value or use spot AE point light metering.
	The subject is beyond the range of the flash.	When flash is used, the distance between lens and subject should not exceed 4.4 m (14.4 ft.) at wide angle end or 2.5 m (8.2 ft.) at telephoto end setting.

<b>Problem</b>	<b>Cause</b>	<b>Solution</b>
The subject comes out overexposed (too bright).	The subject is too close to the flash.	When flash is used, the distance between lens and subject should be no less than 25 cm (10 in.).
	The subject is brighter than the surroundings.	Set exposure compensation to a negative value.
	Light is shining or reflecting into the camera.	Adjust the camera angle.
	The flash mode is set so that the flash always fires.	Set the flash to any other mode except On.
A purple-red or other color vertical stripe appears on the upper part of the LCD monitor	Subject is too bright	This is a normal occurrence in devices containing CCDs and does not constitute a malfunction. (This red bar of light will not be recorded when shooting still photos, but it will be recorded when shooting movies.)

<b>Problem</b>	<b>Cause</b>	<b>Solution</b>
White dots or white asterisks appear on the image	Light from the flash has reflected off dust particles or insects in the air. This occurs more frequently in the following conditions: - When shooting at the wide-angle end. - When shooting with a high aperture value in the aperture-priority AE mode.	This is a phenomenon that occurs with digital cameras and does not constitute a malfunction.
The flash doesn't fire.	The flash mode is set to Off.	Set the flash to any other mode except Off.
Image not showing on TV.	Incorrect video system setting.	Set the video system to the appropriate setting, NTSC or PAL, for your TV.
	The mode dial is turned to  (stitch assist).	Turn the mode dial to any mode other than  .
Zoom does not operate.	Zoom button was pressed while shooting in movie mode.	Operate the zoom before shooting in movie mode.
Reading images from CF card is slow	CF card was formatted in another device	Use a CF card formatted in your camera. See <i>Formatting a CF Card</i> (p. 138)
Recording images to CF card takes a long time		



# Specifications

All data is based on Canon's standard testing methods.  
Subject to change without notice.

## PowerShot A80

<b>Camera Effective Pixels</b>	Approx. 4 million
<b>Image Sensor</b>	1/1.8-inch CCD (Total number of pixels: Approx. 4.1 million)
<b>Lens</b>	7.8 (W) – 23.4 (T) mm (35mm film equivalent: 38 (W) – 114 (T) mm) f/2.8 (W) – 4.9 (T)
<b>Digital Zoom</b>	Approx. 3.6x (Up to approx. 11x in combination with the optical zoom)
<b>Optical Viewfinder</b>	Real-image zoom viewfinder
<b>LCD Monitor</b>	1.5-inch, amorphous silicon TFT color LCD, approx. 67,000 pixels (Picture coverage approx. 100%)
<b>AF System</b>	TTL autofocus 9-point AiAF/1-point AF (center) Focus lock and Manual focus are available.
<b>Shooting Distance (from the front of the lens)</b>	Normal AF: 45 cm (1.5 ft.) – infinity Macro AF: 5 – 45 cm (W)/25 – 45 cm (T) (2.0 in. – 1.5 ft. (W)/9.8 in. – 1.5 ft. (T)) Manual focus: 5 cm – infinity (W)/25 cm – infinity (T) (2.0 in. – infinity (W)/9.8 in. – infinity (T))
<b>Shutter</b>	Mechanical shutter + electronic shutter
<b>Shutter Speeds</b>	15 – 1/2000 sec. 1.3 sec. or slower shutter speeds are available in Shutter-priority mode or Manual mode. Slow shutter speeds of 1.3 sec. or slower operate with noise reduction.
<b>Light Metering System</b>	Evaluative, Center-weighted average or Spot (center)
<b>Exposure Control System</b>	Program AE, Shutter-priority AE, Aperture-priority AE or Manual exposure control
<b>Exposure Compensation</b>	± 2.0 stops in 1/3-stop increments
<b>Sensitivity</b>	Auto, ISO 50/100/200/400 equivalent

(W): Wide-angle end, (T): Telephoto end

<b>White Balance</b>	TTL auto white balance, pre-set white balance (available settings: Daylight, Cloudy, Tungsten, Fluorescent or Fluorescent H) or custom white balance
<b>Built-in Flash</b>	Auto*, on*, off * Red-eye reduction is available.
<b>Flash Range</b>	Normal: 45 cm – 4.4 m (1.5 – 14.4 ft.) (W), 45 cm – 2.5 m (1.5 – 8.2 ft.) (T) Macro: 25 cm – 45 cm (9.8 in. – 1.5 ft.) (W/T) (When sensitivity is set to AUTO.)
<b>Shooting Modes</b>	Auto Creative zone: Program, Shutter-speed priority, Aperture priority, Manual, Custom1 and Custom2 Image zone: Portrait, Landscape, Night scene, Fast shutter, Slow shutter, Stitch assist and Movie
<b>Continuous Shooting</b>	High-speed: Approx. 2.4 shots/sec. Normal: Approx. 1.6 shots/sec. (Large/Fine mode with LCD monitor off)
<b>Self-timer</b>	Activates shutter after an approx. 2-sec./approx. 10-sec. delay
<b>PC-controlled Shooting</b>	Available (USB connection only. Exclusive software program is included in the camera kit.)
<b>Recording Media</b>	CompactFlash™ (CF) card (Type I)
<b>File Format</b>	Design rule for camera file system and DPOF compliant
<b>Image Recording Format</b>	Still images: JPEG (Exif 2.2)* <sup>1</sup> Movies: AVI (Image data: Motion JPEG; Audio data: WAVE (monaural))
<b>Compression</b>	Super fine, Fine, Normal
<b>Number of Recording Pixels</b>	Still images: Large: 2272 × 1704 pixels Medium 1: 1600 × 1200 pixels Medium 2: 1024 × 768 pixels Small: 640 × 480 pixels Movies: 320 × 240 pixels (approx. 3 min.)* 160 × 120 pixels (approx. 3 min.)* Approx. 15 frames/second * The data in parentheses refer to the maximum movie length per shooting.

<b>Playback Modes</b>	Single (histogram displayable), Index (9 thumbnail images), Magnified (approx. 10x (max.) in LCD monitor), Sound memos (up to 60 sec.), Auto play or image output to direct print compatible CP-series (CP-300/CP-200/CP-100/CP-10) and Bubble Jet printers.
<b>Display Languages</b>	12 languages available for menus and messages (English, Deutsch, Français, Nederlands, Dansk, Suomi, Italiano, Norsk, Svenska, Español, Chinese and Japanese)
<b>My Camera Settings</b>	The start-up image, start-up sound, shutter sound, operation sound and self-timer sound can be customized using the following methods: <ol style="list-style-type: none"> <li>1. Using the images and sounds recorded on the camera.</li> <li>2. Using downloaded data from your computer using the supplied software.</li> </ol>
<b>Interface</b>	USB (mini-B, PTP [Picture Transfer Protocol]) Audio/Video output (NTSC or PAL selectable, monaural audio)
<b>Power Source</b>	Four AA alkaline batteries (included in the camera kit) Four AA rechargeable NiMH batteries (sold separately) AC Adapter Kit ACK600 (sold separately)
<b>Operating Temperature</b>	0 – 40 °C (32 – 104 °F)
<b>Operating Humidity</b>	10 – 90%
<b>Dimensions</b>	103.1 × 64.6 × 34.7 mm (4.1 × 2.5 × 1.4 in.) (excluding protrusions)
<b>Weight</b>	Approx. 250 g (8.8 oz.) (camera body only)

\*1This digital camera supports Exif 2.2 (also called “Exif Print”). Exif Print is a standard for enhancing the communication between digital cameras and printers. By connecting to an Exif Print-compliant printer, the camera’s image data at the time of shooting is used and optimized, yielding extremely high quality prints.

## Battery Performance

	Number of Shots		Playback Time
	LCD Monitor ON	LCD Monitor OFF	
AA Alkaline Batteries (included with the camera)	Approx. 250 shots	Approx. 800 shots	Approx. 280 min.
AA NiMH Battery NB-1AH	Approx. 350 shots	Approx. 1000 shots	Approx. 280 min.

\* The data above reflects standard Canon testing conditions. The actual figures will vary according to the shooting conditions and settings.













### Test Conditions





Shooting: Normal temperature (23° C, 73° F), alternating wide angle end and telephoto end shots at 20-second intervals with flash fired once every four shots and camera power turned off and on every eighth shot.

Playback: Normal temperature (23° C, 73° F), continuous playback at one image per 3 seconds.





**See pages 21 and 182 for battery handling information.**

## CF Cards and Estimated Capacities (Recordable Images)

		FC-16M	FC-32M	FC-64M	FC-128M	FC-256MH
<b>L</b>		7	14	30	61	123
		13	27	54	110	222
		26	54	110	220	443
<b>M1</b>		14	30	61	122	246
		26	54	109	219	440
		52	108	217	435	868
<b>M2</b>		25	53	107	215	431
		46	94	189	379	762
		84	174	349	700	1390
<b>S</b>		58	120	241	482	962
		94	196	393	788	1563
		165	337	676	1355	2720
<b>Movie</b> (in seconds)		44	91	183	368	735
		118	242	486	973	1954

- The maximum recording time for a movie clip is approx. 3 minutes. Figures shown in the table are the maximum continuous recording times.
-  (Superfine),  (Fine) and  (Normal) indicate the relative compression ratio.
- **L** (Large), **M1** (Medium), **M2** (Medium), **S** (Small),  and  indicate the following resolutions.

### Approximate Image File Size (Estimated)

				
<b>L</b>	(2272 × 1704 pixels)	2002KB	1116KB	556KB
<b>M1</b>	(1600 × 1200 pixels)	1002KB	558KB	278KB
<b>M2</b>	(1024 × 768 pixels)	570KB	320KB	170KB
<b>S</b>	( 640 × 480 pixels)	249KB	150KB	84KB
<b>Movie</b>	 ( 320 × 240 pixels)	330 KB/Sec		
	 ( 160 × 120 pixels)	120 KB/Sec		

## NiMH Battery NB-1AH

Supplied with the separately sold NiMH Battery NB4-100 set and the Battery/Charger Kit CBK100.

Type	Rechargeable nickel metal hydride battery
Nominal Voltage	1.2 V DC
Typical Capacity	1600 mAh (Lowest : 1550 mAh)
Cycle Life	Approx. 300 times
Operating Temperature	0 – 35 °C (32 – 95 °F)
Dimensions	Diameter: 14.5 mm (0.6 in.) Length: 50 mm (2 in.)
Weight	Approx. 27 g (0.95 oz.)

## Battery Charger CB-3AH

Supplied with the separately sold Battery and Charger Kit CBK100.

Rated Input	100 – 240 V AC (50/60 Hz), 8 W
Rated Output	1.6 V DC/2 A
Charging Time	Approx. 220 minutes*
Operating Temperature	0 – 35 °C (32 – 95 °F)
Dimensions	113 × 74 × 27.5 mm (4.4 × 2.9 × 1.1 in.)
Weight (body)	Approx. 100 g (3.5 oz.)

\* To charge four NB-1AH NiMH Batteries

## Compact Power Adapter CA-PS500

Supplied with the separately sold AC Adapter Kit ACK600.

Rated Input	100 – 240 V AC (50/60 Hz), 0.17 A
Rated Output	4.3 V DC/1.5 A
Operating Temperature	0 – 40 °C (32 – 104 °F)
Dimensions	42.5 × 104.4 × 31.4 mm (1.7 × 4.1 × 1.2 in.)
Weight (body)	Approx. 180 g (6.3 oz.)

## CompactFlash™ Card

Card Slot Type	Type I
Dimensions	36.4 × 42.8 × 3.3 mm (1.4 × 1.7 × 0.1 in.)
Weight	Approx. 10 g (0.4 oz.)

## Wide Converter WC-DC52 (sold separately)

Magnification	Approx. 0.7× (35mm film equivalent at wide angle end: approx. 26.6 mm)
Focusing Range (from tip of lens)	Approx. 0.5 cm (0.2 in.) – infinity (when mounted on PowerShot A80, at wide angle end)
Thread Diameter	52 mm standard filter thread (Conversion Lens Adapter LA-DC52D is required for mounting to PowerShot A80)
Dimensions	Diameter: 55.7 mm (2.2 in.) Length: 23.7 mm (0.9 in.)
Weight	Approx. 74 g (2.6 oz.)

## Tele-converter TC-DC52A (sold separately)

Magnification	Approx. 1.75× (35mm film equivalent at telephoto end: approx. 200 mm)
Focusing Range (from tip of lens)	Approx. 2.2 m (Approx. 7.2 ft.) – infinity (when mounted on PowerShot A80, at telephoto end)
Thread Diameter	52 mm standard filter thread (Conversion Lens Adapter LA-DC52D is required for mounting to PowerShot A80)
Dimensions	Diameter: 55.2 mm (2.2 in.) Length: 49.3 mm (1.9 in.)
Weight	Approx. 77 g (2.7 oz.)

### **Close-Up Lens 250D 52mm (sold separately)**

Focal Length	250 mm
Focusing Range	4 – 25 cm (1.6 – 9.8 in.) (W)/8 – 25 cm (3.2 – 9.8 in.) (T) (when mounted on PowerShot A80)
Thread Diameter	52 mm standard filter thread (Conversion Lens Adapter LA-DC52D is required for mounting to PowerShot A80)
Dimensions	Diameter: 54 mm (2.1 in.) Length: 10.2 mm (0.4 in.)
Weight	Approx. 55 g (1.9 oz.)

### **Conversion Lens Adapter LA-DC52D (sold separately)**

Thread Diameter	52 mm standard filter thread
Dimensions (from tip of lens)	Diameter: 55.6 mm (2.2 in.) Length: 28.7 mm (1.1 in.)
Weight (body)	Approx. 11 g (0.39 oz.)





**COPY**

Appendix 

# Index

## A

AC Adapter Kit 184  
AF Frame  
    Auto Selection 96  
    Manual Selection 96  
Aperture-Priority AE (**Av**) 91  
Aperture Value 88, 91, 94  
Auto Mode (**AUTO**) 56  
Auto Play 134  
Auto Rotate 118  
A/V Out Terminal 155

## B

Batteries  
    Battery Cover 17  
    Change 20  
    Handling Precautions 21  
    Installing 20  
    Low Status 23  
    Performance 202  
    Rechargeable Batteries 182  
    Status 23  
Beep 172, 173, 177  
Black and White Mode 107

## C

Care 191  
CF Card 24  
    CF Card Reader 154  
    Downloading Images 150  
    Formatting 138  
    Handling 25  
    Installing 24  
    Recording Capacity 203  
    Slot Cover 17  
Cleaning 191  
CompactFlash™ Card  
    24, 25, 135, 203  
Components 16

Compression 60, 203  
Continuous Shooting () 84  
Creative Zone 19  
Custom Settings 116

## D

Date/Time 26, 173  
Default Settings 52 - 55  
Digital Terminal 16, 155  
Digital Zoom 43, 82, 168  
Display Modes 36 - 41  
    Detailed 36, 37  
    Standard 36, 37  
DPOF  
    Print Settings 142, 147  
    Transfer Order 148

## E

Erasing  
    All Images 137  
    Displayed Images 15  
    Single Images 136  
Exposure  
    Aperture-Priority AE (**Av**) 91  
    Compensation 99  
    Shutter-Priority AE (**Tv**) 88  
    White Balance 102  
Exposure Compensation 99

## F

Fast Shutter 70  
File No. Reset 120  
File Numbers 120  
Flash 64  
Focus  
    Lock 112  
    Manual 114  
Format 138

## H

Household Power Source 182

## I

Image Zone 19

Index Playback 124

Indicators 18

Information View 36 - 41

Interface

Cables 16, 155

ISO Speed 109

## J

Jump 125

## L

Landscape Mode (🏞️) 68

Language 29, 175

LCD Monitor 34 - 41

Lens 16

Close-up Lens 187

Conversion Lens Adapter 188

Tele-converter 187

Wide Converter 187

Light Metering

Center-Weighted Averaging 97

Evaluative 97

Spot AE Point 97

## M

Macro Mode (🌸) 78

Magnifying Images 123

Manual

Exposure (M) 94

Focus (MF) 114

Shooting Mode 94

Menu

FUNC. 165

List of Options 165

Play 170

Rec 167

Selecting 47

Set up 172

Messages 180

Microphone 16

Movie (🎬)

Editing 128

Playback 126

Shooting 76

My Camera

Menu 176

Registering 160

Settings 157

## N

Night Scene Mode (🌃) 69

## O

Operation Sound

157 - 159, 176 - 177

## P

Photo Effect 107

Play 122

Playback

Auto Play 134

Index Playback 124

Jumping 125

LCD Monitor 34

Magnifying Images 123

Movies 126

Rotating 131

Single Image Playback 122

Portrait Mode (👤) 67

Program AE (P) 86

Protect 135, 170

Printing 140

Settings 142

Selecting Images 142

Print Type 145

Resetting 147  
Power On/Off 31 - 32  
Power Saving 32, 173  
Power Source  
AC Adapter 184  
Rechargeable Batteries 182

## R

Recordable Images 203  
Red-Eye Reduction 65  
Remaining Movie Time 203  
Resolution 60  
Resetting the settings to default 178  
Ring Release Button 16, 189  
Rotate 131

## S

Self-Timer 80  
Sound 157 - 159, 177  
Volume 172  
Shooting 33, 56  
Checking Images 58  
Switching from Playback Mode 33  
TV Set 155  
Shooting Mode 212  
Dial 19  
Functions Available 212  
Shutter  
Sound 157 - 159, 172, 177  
Shutter-Priority AE (**Tv**) 88  
Speed 88, 91, 94  
Volume 173  
Shutter Button 44  
Pressing Halfway 44  
Pressing Fully 45  
Single Image Playback 122  
Slow Shutter 71  
Sound Memos 132  
Speaker 16  
Specifications 199 - 206

Spot Light Metering 97  
Start-up  
Image 31, 157 - 159, 176  
Sound 31, 157 - 159, 176  
Stitch Assist Mode (  ) 72  
Framing Subjects 72  
Shooting 73  
Strap 17

## T

Telephoto 43  
Transfer Order  
Reset 148  
Selecting Images 148  
Troubleshooting 192 - 198

## V

Video System 155, 175  
Viewfinder  
LCD Monitor 17, 34  
Optical 17, 42  
Volume  
Playback 173  
Shooting 172

## W

WAVE Files 40, 41, 132  
White Balance 102  
Wide Angle 43

## Z

Zoom 43, 82, 123

## **FCC Notice**

(Digital Camera, Model PC1059)

This device complies with Part 15 of the FCC Rules. Operation is subject to the following two conditions;

- (1) this device may not cause harmful interference, and
- (2) this device must accept any interference received, including interference that may cause undesired operation.

Note: This equipment has been tested and found to comply with the limits for Class B digital devices, pursuant to Part 15 of the FCC rules. These limits are designed to provide reasonable protection against harmful interference in a residential installation. This equipment generates, uses and can radiate radio frequency energy and, if not installed and used in accordance with the instructions, may cause harmful interference to radio communications. However, there is no guarantee that interference will not occur in a particular installation. If this equipment does cause harmful interference to radio or television reception, which can be determined by turning the equipment off and on, the user is encouraged to try to correct the interference by one or more of the following measures:

- Reorient or relocate the receiving antenna.
- Increase the separation between the equipment and receiver.
- Connect the equipment into an outlet on a circuit different from that to which the receiver is connected.
- Consult the dealer or an experienced radio/TV technician for help.

The cables with the ferrite core provided with the digital camera must be used with this equipment in order to comply with Class B limits in Subject B of Part 15 on the FCC rules.

Do not make any changes or modifications to the equipment unless otherwise specified in the manual. If such changes or modifications should be made, you could be required to stop operation of the equipment.

### **Canon U.S.A. Inc.**

One Canon Plaza, Lake Success, NY 11042, U.S.A.  
Tel No. (516) 328-5600

## **Canadian Radio Interference Regulations**

























THIS CLASS B DIGITAL APPARATUS MEETS ALL REQUIREMENTS OF THE CANADIAN INTERFERENCE CAUSING EQUIPMENT REGULATIONS.

## **Réglementation canadienne sur les interférences radio**











CET APPAREIL NUMERIQUE DE LA CLASSE B RESPECTE TOUTES LES EXIGENCES DU REGLEMENT SUR LE MATERIEL BROUILLEUR DU CANADA.

## Functions Available in Each Shooting Mode

This chart shows the functions available in each shooting mode. In the **C1** and **C2** modes, shooting can be done with registered settings (p. 116).

							
Resolution	Large	<b>L</b>	●*	●*	●*	●*	●*
	Medium 1	<b>M1</b>	●	●	●	●	●
	Medium 2	<b>M2</b>	●	●	●	●	●
	Small	<b>S</b>	●	●	●	●	●
Resolution	Movie		—	—	—	—	—
	Movie		—	—	—	—	—
Compression	Superfine		●	●	●	●	●
	Fine		●*	●*	●*	●*	●*
	Normal		●	●	●	●	●
Flash	Auto		●*	●*	●	●*	●*
	On		—	●	●	●	●
	Off		●	●	●*	●	●
Red-Eye Reduction			●	●	●	●	●
Flash Output			—	—	—	—	—
AF-assist Beam			●	●	●	●	●
Drive Mode	Single Shot		●*	●*	●*	●*	●*
	Continuous Mode		—	●	●	●	●
	Fast Continuous Mode		—	●	●	●	●
	Self-timer (10 sec.)		●	●	●	●	●
	Self-timer (2 sec.)		●	●	●	●	●
AF Frame			—	●	●	●	●
Manual Focus			—	●	●	●	●
Macro Mode			●	●	—	●	●

			<b>P</b>	<b>Tv</b>	<b>Av</b>	<b>M</b>	Reference Page
●*	▲*	—	●*	●*	●*	●*	60
●	▲	—	●	●	●	●	
●	▲	—	●	●	●	●	
●	▲	—	●	●	●	●	
—	—	●*	—	—	—	—	60
—	—	●	—	—	—	—	
●	▲	—	●	●	●	●	60
●*	▲*	—	●*	●*	●*	●*	
●	▲	—	●	●	●	●	64
●	—	—	●	—	—	—	
●	▲	—	●	●	●	●	65
●*	▲*	—	●*	●*	●*	●*	
—	—	—	—	—	—	●	111
●	▲	●	●	●	●	●	46
●*	▲*	●*	●*	●*	●*	●*	—
●	—	—	●	●	●	●	84
●	—	—	●	●	●	●	
●	▲	●	●	●	●	●	80
●	▲	●	●	●	●	●	
●	—	—	●	●	●	●	96
●	—	●	●	●	●	●	114
●	▲	●	●	●	●	●	78

		<b>AUTO</b>				
Digital Zoom 	On	●	●	●	●	●
	Off	●*	●*	●*	●*	●*
Exposure Compensation 		—	●	●	●	●
Light Metering System	Evaluative Metering 	●	●	●	●	●
	Center-Weighted Averaging 	—	—	—	—	—
	Spot Metering 	—	—	—	—	—
White Balance <sup>(1)</sup> <b>WB</b>		— <sup>(2)</sup>	●	●	●	●
Photo Effect 		—	●	●	●	●
ISO Speed <b>ISO</b>		— <sup>(3)</sup>	— <sup>(3)</sup>	— <sup>(3)</sup>	— <sup>(3)</sup>	— <sup>(3)</sup>
Auto Rotate 	On	●	●	●	●	●
	Off	●	●	●	●	●

\* : Default, ● : Available, ▲ : Available, but cannot be changed after taking the first shot, — : Not available  
 : Setting is retained even after power off.

The default for the settings changed by the menu and button operations can be restored all at once except for [Date/Time], [Language] and [Video System] (p. 178)

- (1) The photo effect [Sepia] and [B/W] cannot be selected.
- (2) The white balance is set to [AUTO].
- (3) The ISO speed is automatically set by the camera.
- (4) ISO [AUTO] cannot be selected.