











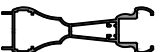

CODICE	PROFILO	PESO Kg/m	PAG.
NX10027		1,388	05
NX10014		1,026	05
NX4019		1,150	05
NX10080		0,869	05
NX10489		0,748	05
NX10333		0,546	06
NX10279		0,659	06
NX10026		0,689	06
NX4018		1,097	06
NX10015		1,002	06
NX3821		0,886	06

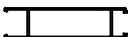

NX10027 | 1,388 Kg/m

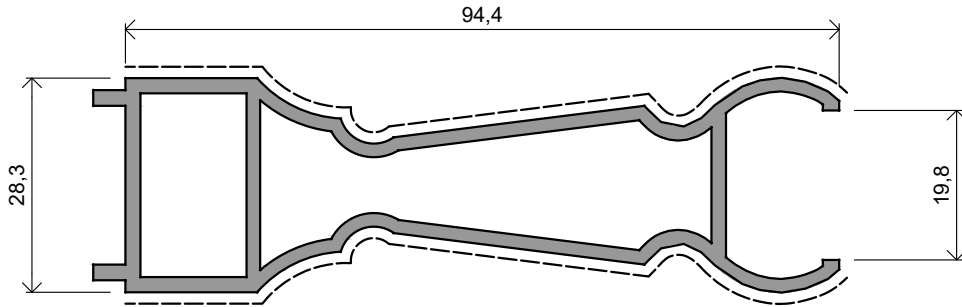
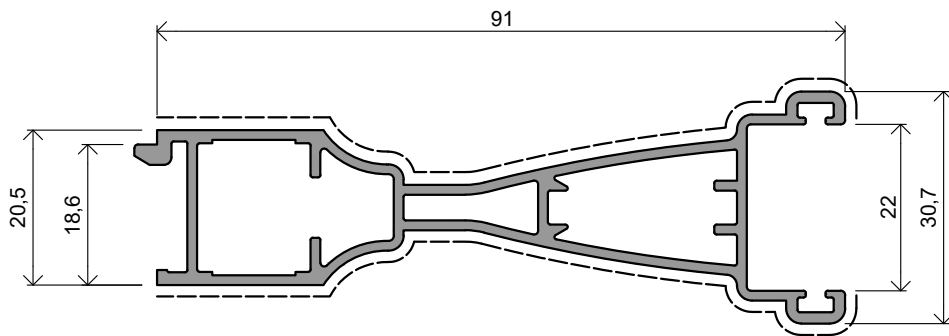

NX10014 | 1,026 Kg/m

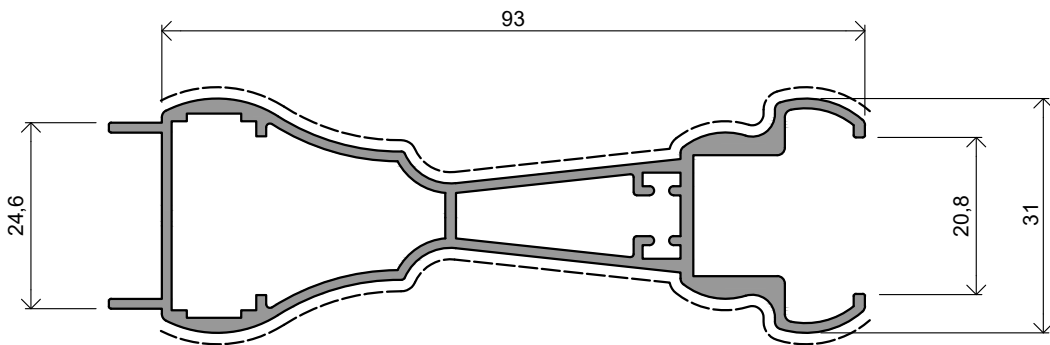

NX4019 | 1,150 Kg/m

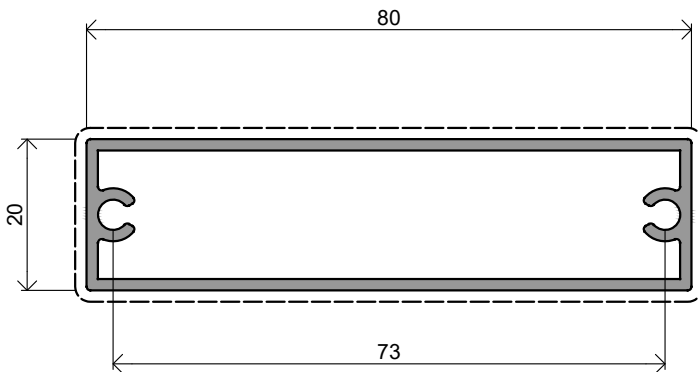

NX10080 | 0,869 Kg/m

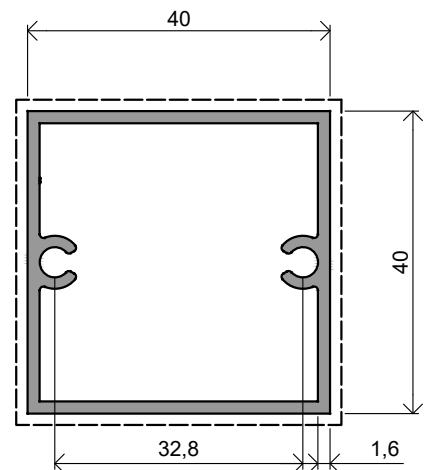

NX10489 | 0,748 Kg/m



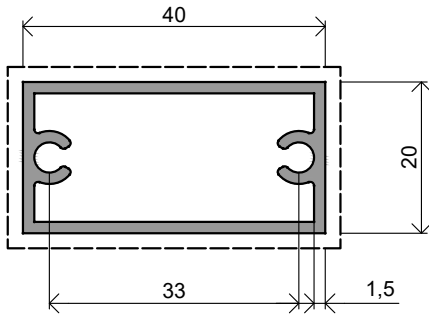

NX10333 | 0,546 Kg/m

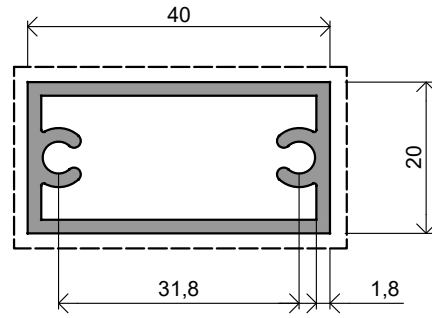

NX10279 | 0,659 Kg/m

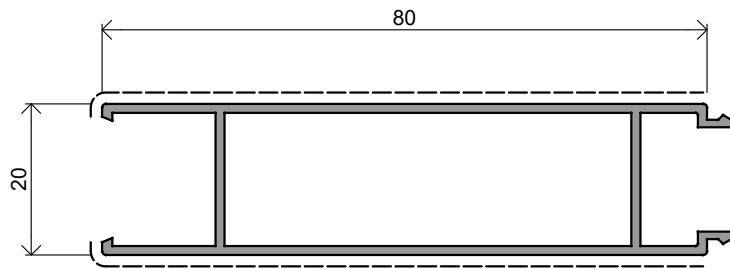

NX10026 | 0,689 Kg/m

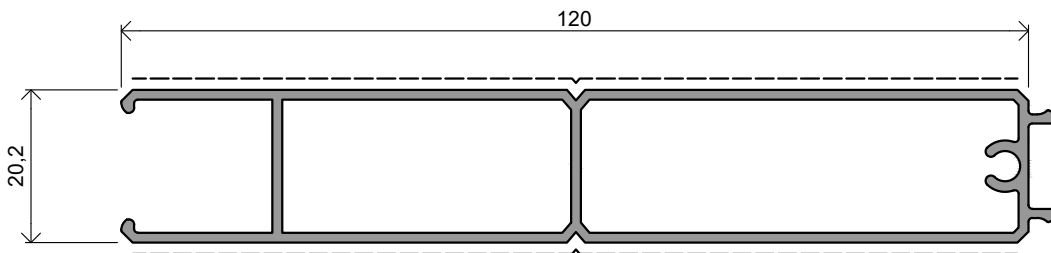

NX4018 | 1,097 Kg/m

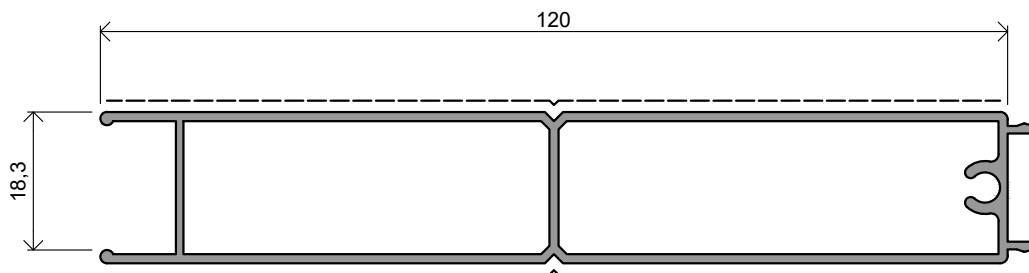

NX10015 | 1,002 Kg/m

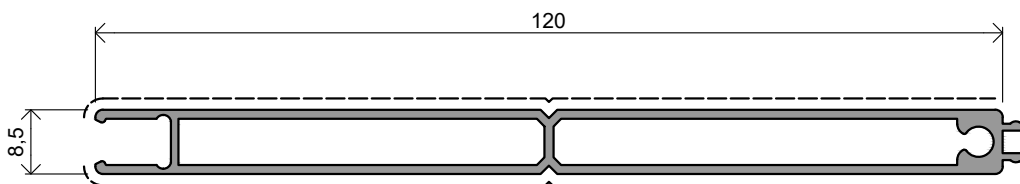

NX3821 | 0,886 Kg/m

