

Symbolenlijst systeemwijzer

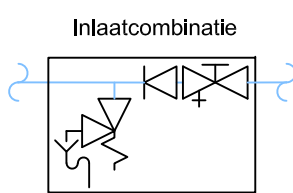

Bosch Compress 3400i AE met losse boiler

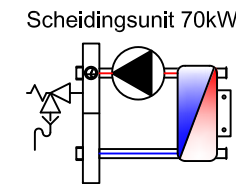
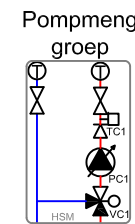
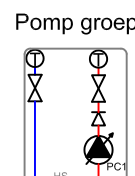
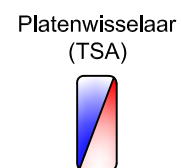
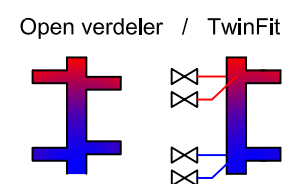
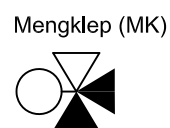
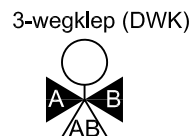
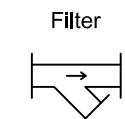
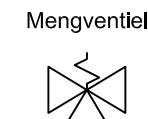
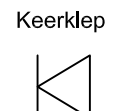
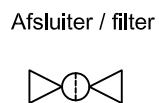
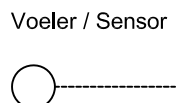
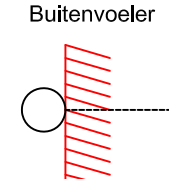
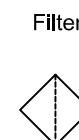
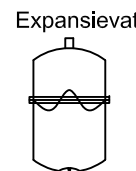
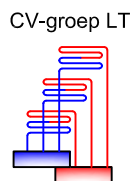
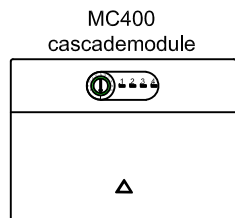
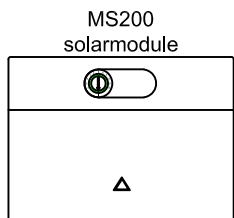
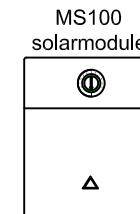
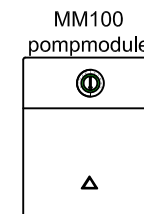
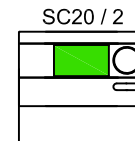
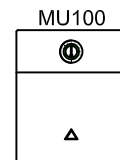
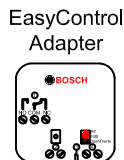
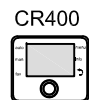
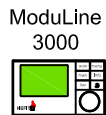
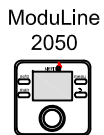
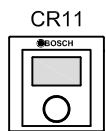
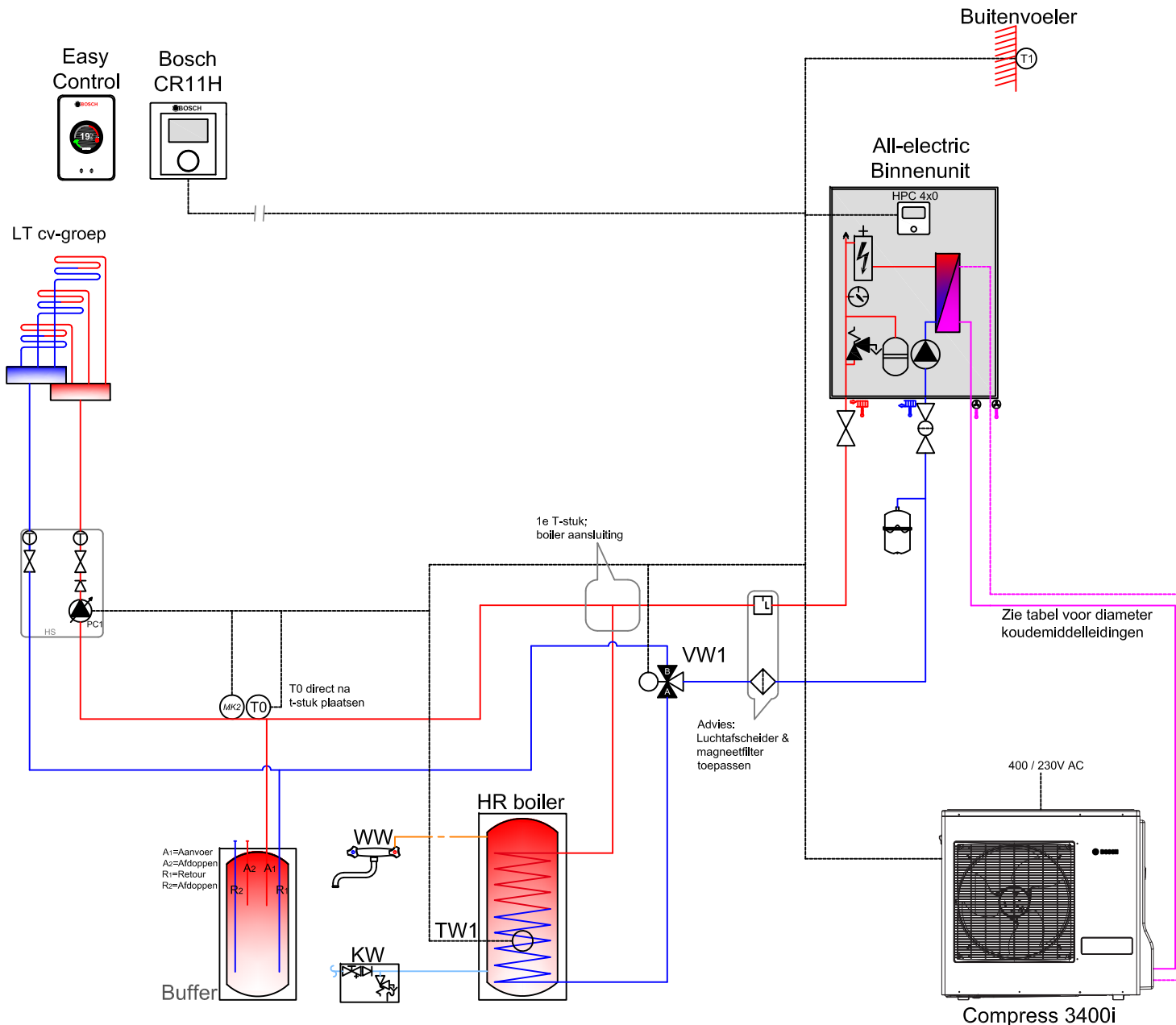

CS3400i ODU	Koudemiddelleidingen	Koudemiddel
4 OR-S	12,7 (1/2") 6,35 (1/4")	R32
6 OR-S	15,88 (5/8") 6,35 (1/4")	R32
8 OR-S	15,88 (5/8") 6,35 (1/4")	R32
10 OR-S	15,88 (5/8") 6,35 (1/4")	R32
10 OR-T	15,88 (5/8") 9,52 (3/8")	R410A
12 OR-T	15,88 (5/8") 9,52 (3/8")	R410A
14 OR-T	15,88 (5/8") 9,52 (3/8")	R410A

Zie tabel voor diameter koudemiddelleidingen

Omschrijving

Bij de Bosch Compress 3400i wordt een losse HR warmtepomp boiler bijgeplaatst. Indien de warmtepomp niet voldoende vermogen kan leveren wordt er door middel van het elektrisch element naverwarmd. De warmtepomp is modulerend en regelt altijd weersafhankelijk. Waterzijdig inregelen en ontluften is essentieel voor het goed functioneren van de verwarmingsinstallatie.

Aandachtspunten

- Expansievat toestel heeft beperkte inhoud. Afhankelijk van afgiftesysteem tweede expansievat toepassen.
 - Indien de voeding van de buitenunit uit de binnenunit komt, moet het vermogen van het elektrisch element beperkt worden tot:
 - 4 t/m 10 OR-S element beperken tot 3,9kW;
 - 10 t/m 14 OR-T element beperken tot 6kW.
- Bij toepassing Easycontrol:
- CV-circuit selecteren op Easycontrol
 - Configuratie-assistent starten op HPC4x0
- Indien koeling van toepassing:
- Primaire circuit dampdicht isoleren (aanbevolen)
 - CR11H verplicht
 - Dauwpuntsensor MK2 aanbevelen

Dit is een prinseschema, geen werktekening. Productwijzigingen voorbehouden.
 U dient zelf te controleren of het geselecteerde systeem voldoet aan de eisen die voor uw project van toepassing zijn. Hierin accepteert Nefit-Bosch geen verantwoordelijkheid.

HPC 4x0

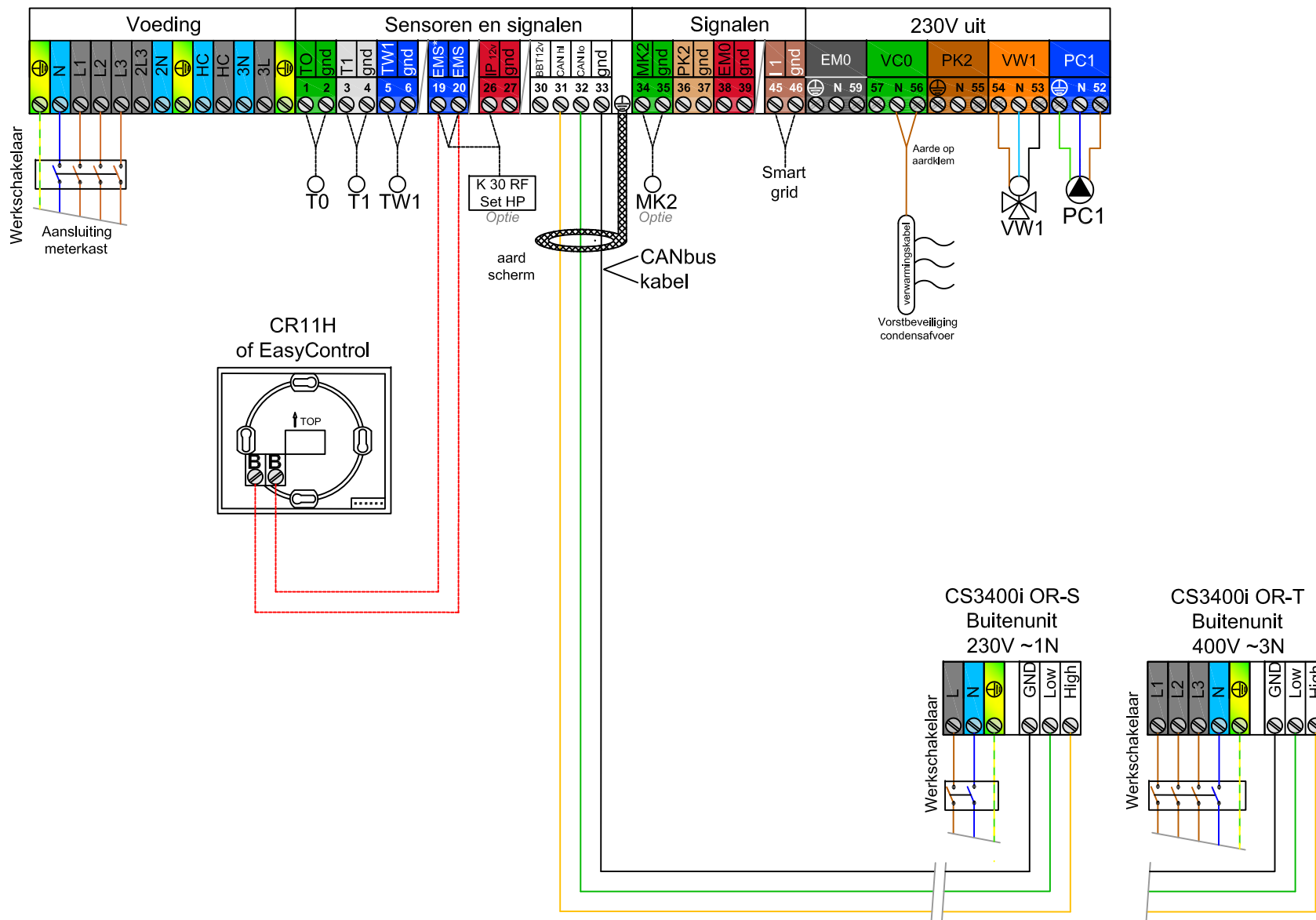

----- BUS interface EMS