

高壓穿牆套管

Wall through Bushing



7.2KV

額定 / 耐壓 / 衝擊 - 7.2 / 22 / 60 KV

BU-07-01



BMC

訂貨編號:802.0H011.0001

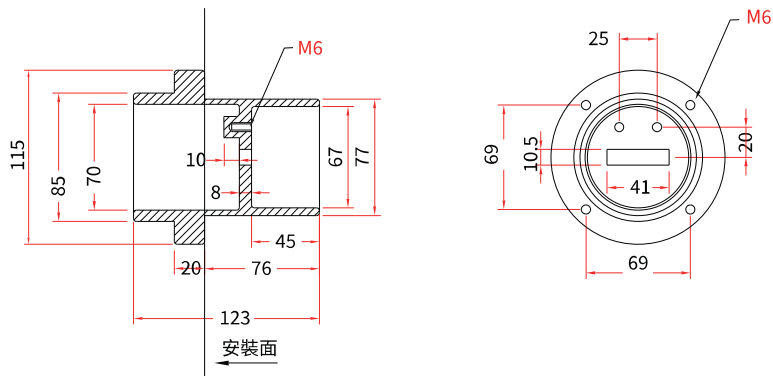

額定 / 耐壓 / 衝擊 - 7.2 / 22 / 60 KV

BU-07-02



BMC

訂貨編號:802.0H010.0001

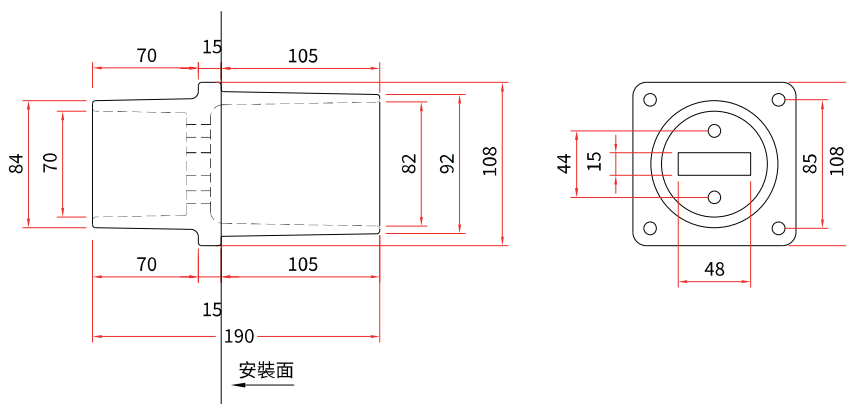

12KV

額定 / 耐壓 / 衝擊 - 12 / 36 / 75 KV

局部放電 < 3PC

BU-TH130



Epoxy Mold

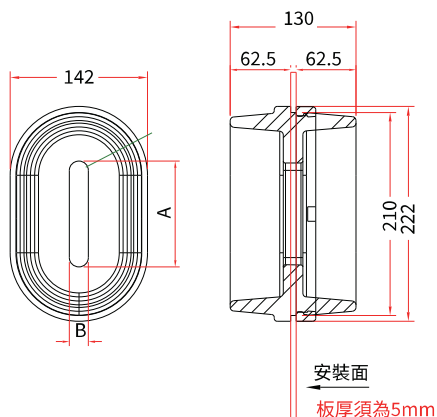

訂貨代碼	A	B
801.3H000.0101	16	
801.3H000.0201	40	130
801.3H000.0301	60	

高壓穿牆套管

Wall through Bushing



12KV

額定 / 耐壓 / 衝擊 - 12 / 36 / 75 KV

局部放電 < 3PC

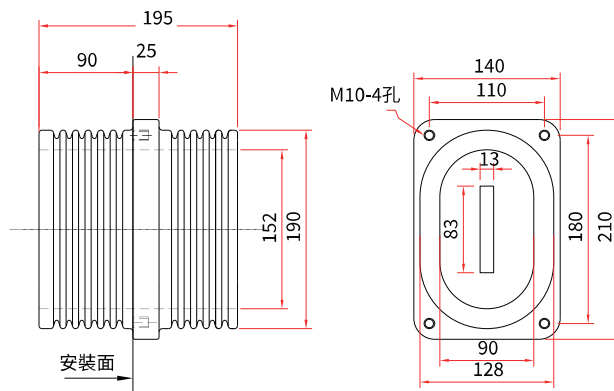
BU-TH195
Epoxy Mold

額定 / 耐壓 / 衝擊 - 12 / 54 / 96 KV

局部放電 < 3PC

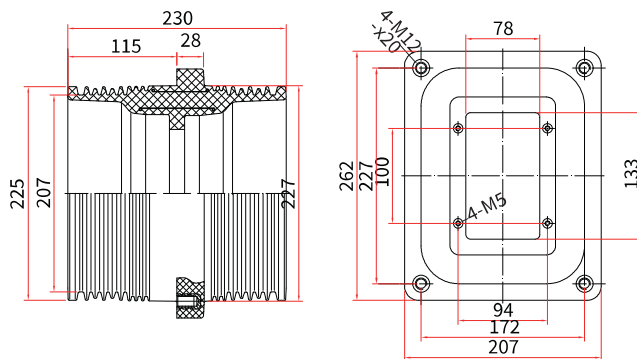
BU-TH230
Epoxy Mold

此款特製雙遮蔽，
且符合UL-94V0，
使用於大電流。

24KV

額定 / 耐壓 / 衝擊 - 24 / 60 / 125 KV

局部放電 < 3PC

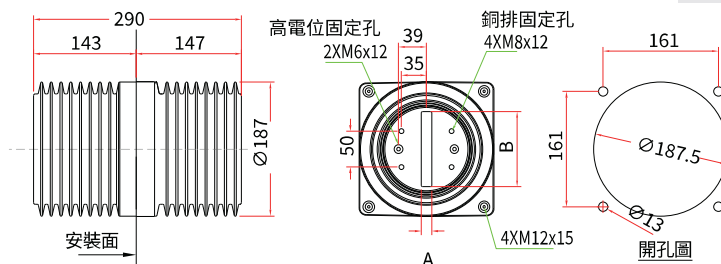
BU-TH290
Epoxy Mold

訂貨代碼	型號	A	B
801.3H500.0007	BU-TH290-A1	15	105
801.3H500.0004	BU-TH290-B1(遮蔽)		
801.3H500.0005	BU-TH290-A2	40	105
801.3H500.0006	BU-TH290-B2(遮蔽)		

36KV

額定 / 耐壓 / 衝擊 - 36 / 80 / 200 KV

局部放電 < 3PC

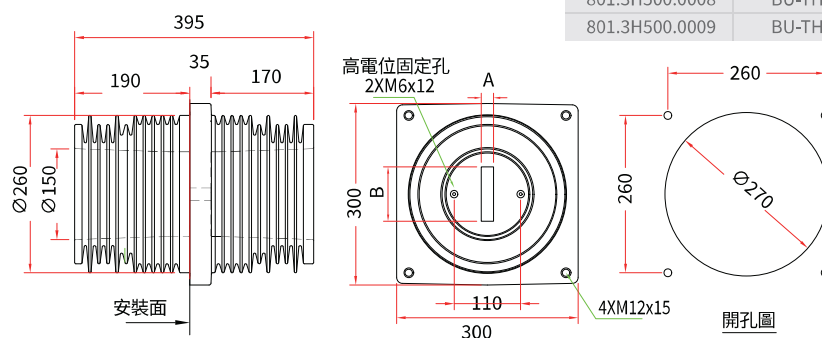
BU-TH395
Epoxy Mold

訂貨代碼	型號	A	B
801.3H500.0008	BU-TH395-A1	20	90
801.3H500.0009	BU-TH395-A2	40	110

高壓穿牆套管

Wall through Bushing



	T	W
a	16	130
b	40	130
c	60	130
d	Ø35	

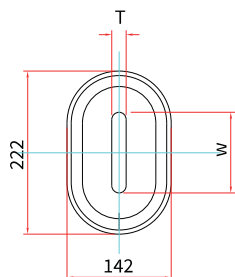

	參考尺寸	A	B	C	D
TB-H3	12KV	150	250	600	400
	直向 24KV	290	250	1050	540
TB-V3	12KV	250	250	1000	400
	橫向 24KV	280	250	1040	420

TB-H3

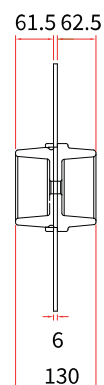
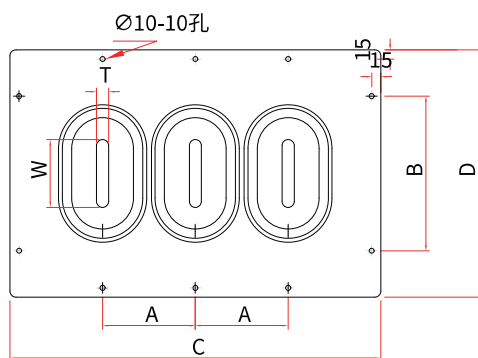

TB-V3

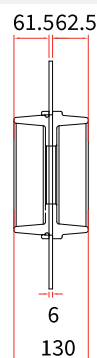
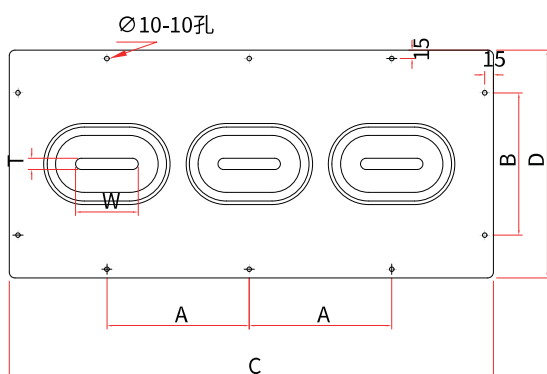

TB-1

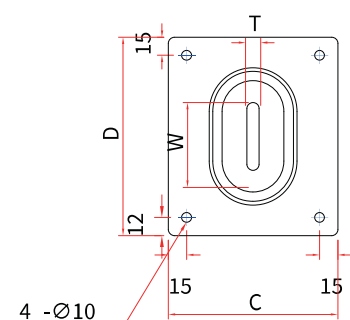

	KV	C	D
TB-1-07	7.2	200	264
TB-1-12	12	230	285
TB-1-15	15	280	355