

Think Controls

FOTEK

Self-adaptive Fuzzy + PID Temperature Controller NT series

§ Intelligence
§ Performance
§ Reliability

§ Easiness
§ Stability
§ Sensitivity

Complete Human-interface & Function

- | | |
|-------------|------------------------------------|
| * 輸出量顯示 | * Output volume display |
| * 負載電流量顯示 | * Load current display |
| * 關閉控溫功能 | * Turn off control function |
| * 快速自動演算鍵 | * Fast auto-tuning setting |
| * 緩衝起動功能 | * Soft start function |
| * 加熱斜率控制 | * Ramp control function |
| * 手動輸出控制 | * Manual output control function |
| * 全機種可附通訊功能 | * Communication function available |

UL US CE Rohs



陽明電機股份有限公司
FOTEK CONTROLS CO., LTD.

FOTEK
www.fotek.com.tw

Model guiding / 型號索引

Ex.	NT	-	48	R	-	CT	-	RS		
	1		2	3		4		5		
1	Series (系列名稱)		NT: New generation Temperature controller							
2	Outline (外形) (Unit: mm)		10: 24*48*100	20: 48*96*60	21: 96*48*60	22: 22.6*75*100	32: 32*75*65	48: 48*48*72(1/16 DIN)	72: 72*72*60	96: 96*96*60(1/16 DIN)
3	Output method (輸出方式)		R: Relay (3A/250VAC) ; NT-10R(0.25A/250VAC) V: SSR (30mA/12V) L: Linear output (4~20mA)							
4	Optioned (附加功能)		CT: With Heater break detecting ; NT-10R(0.25A/250VAC) mA: DC current input mV: DC Voltage input							
5	Optioned (附加功能)		RS: With RS-485 communication (MODBUS protocol)				S: PV transmitter			

How to set the function or parameter / 如何設定功能及參數

- 「Temperature setting status」: Press 「SET」 key instantaneously to enter into the temperature setting status.
 - 「Auto-tuning status」: Press 「▲」 key 3 sec to set 「Auto-tuning」, then press 「▲」 key 3 sec to reset it.
 - 「Manu-output status」: Press 「▼」 key 3 sec to turn off the output control, then press the 「SET」 key to set the 「Manu-output volume」. If press 「▼」 key 3 sec may to release 「Manu-output status」.
 - 「Display mode selecting」: Press 「SET」 key 3 sec to select display mode
 - Without CT type: Display 「Output volume」 (u.xx) → then press 「SET」 key 3 sec → to display 「Temperature set value」
 - With CT type: Display 「output volume」 (u.xx) → then press 「SET」 key 3 sec → to display 「Load current」 (xx.xx) → then press 「SET」 key 3 sec → to display 「Temperature set value」
 - 「Parameter setting status」: Press 「F」 key 3 sec to enter into the parameter setting status.
 - 「Alarm setting status」: Press 「SET」 & 「F」 key 3 sec to enter into the Alarm setting status.
 - 「Communication setting status」: Press 「SET」 & 「▼」 key 3 sec to enter into the Communication setting status.
 - 「Soft start function」: At the final parameter of 「setting of alarm」, Press 「SET」 key 3 sec to set the **Soft start setting value 「SV2」**.
the fixed output volume is set by the manual output volume.
 - 「Ramping control」: At the 「rAP」 parameter in the 「setting of alarm」 level, if 「rAP = 0」, it has not the ramping control function.
if 「rAP ≠ 0」, it will perform the ramping control function.
 - 「Display mode setting」: At the 「Sdc」 parameter in the 「Setting of parameter」 level, if 「Sdc = n」, it will be kept on the selected display mode, if 「Sdc = A」, it will be returned to the Temperature set value mode after 10 seconds.
-
- 「溫度值設定狀態」: 按「SET」鍵一下就可進入「溫度值設定狀態」
 - 「自動演算狀態」: 按「▲」鍵3秒可進入「自動演算狀態」; 再按「▲」鍵3秒解除「自動演算狀態」
 - 「手動輸出控溫狀態」: 按「▼」鍵3秒關閉輸出(顯示「OFF」), 再按「SET」鍵3秒後可設定「手動輸出量」(顯示n.xx), 完成手動輸出量設定後如果再按「▼」鍵3秒可解除「手動輸出控溫狀態」回復自動控溫狀態。
 - 「顯示模式選擇」: 按「SET」鍵3秒
 - 無CT型: 「輸出量顯示」(u.xx) → 再按「SET」鍵3秒 → 「溫度設定值顯示」
 - CT型: 「輸出量顯示」(u.xx) → 再按「SET」鍵3秒 → 「負載電流量顯示」(xx.xx) → 再按「SET」鍵3秒 → 「溫度設定值顯示」
 - 「參數設定」: 按「F」鍵3秒: 進入「參數設定」狀態
 - 「警報設定」: 按「SET」&「F」鍵3秒: 進入「警報設定」狀態
 - 「通訊參數設定」: 按「SET」&「▼」鍵3秒: 進入「通訊參數設定」狀態
 - 「緩衝起動設定」: 在警報設定的最後一個參數時按「SET」鍵3秒可設定「緩衝起動設定值(SV2)」, 固定輸出量由手動輸出量設定。
 - 「加熱速率控制」: 可設定警報設定層的參數「rAP」; 「rAP = 0」時沒有溫升速率控制功能, 「rAP ≠ 0」時執行溫升速率控制。
 - 「顯示自動切換設定」: 可設定參數設定層的參數「Sdc」; 「Sdc = n」時持續顯示「選擇顯示模式」; 「Sdc = A」時10秒後會自動切回「溫度設定值顯示模式」。

Fuzzy + PID Intelligent Temperature Controller

General Specification / 共同規格

Fixed method		Panel type						Rail type	
Model	型號	NT-10	NT-48	NT-20	NT-21	NT-72E	NT-96E	NT-22	NT-32
Outline (U t: mm)	外形尺寸	24*48*100	48*48*72	48*96*60	96*48*60	72*72*60	96*96*60	22.6*75*100	32*75*65
Alarm output	警報輸出	Single alarm	Two alarm				Single alarm		Two alarm
Power supply	工作電壓	90~265 VAC/ 50/60 Hz or 24VDC/AC (Optional)							
Power consumption	消耗電流	5 VA max. or 100mA max. (24VDC/AC)							
Input method	輸入方式	PT / K / J / R / S / T / B / E / N / L(Selectable) or 4~mA or 0~10VDC (Optional)							
Control method	控制方式	Fuzzy + PID or ON / OFF selectable							
Control output	控制輸出	Relay or SSR or 4~20mA (Optional)							
Alarm output	警報輸出	Relay 1a (3A/250VAC SPDT)							
Display range	顯示範圍	-999 ~ 9999							
Accuracy of display	顯示精度	± (0.1 % OF F.S. + 1 DIGIT)							
Setting range	設定範圍	-999 ~ 9999							
Memory method	記憶方式	EEPROM							
Insulation resistance	絕緣強度	OVER 50MΩ / 500VDC							
Dielectric strength	耐壓強度	OVER 2.5 KV / 1 MINUTE							
Operating circum.	使用環境	-25°C ~ 80°C ; 35%~85% RH							
EMC standard		ESD : 8 KV Air Discharge (Level3) / EN-61000-4-2 RF Interference : 10V / M / ENV-50140 Burst test : 2KV / EN61000-4-4							

Setting of Communication / 通訊參數設定

Function	Range	Description
<div style="border: 1px solid black; padding: 5px;"> <div style="display: flex; justify-content: space-between;"> <div>Control status 控制狀態</div> <div>8888</div> </div> <div style="margin-top: 5px;"> Press SET & ▼ key 3 sec </div> <div style="display: flex; justify-content: space-between;"> <div>Controller NO. 控制器編號設定</div> <div>Id 1</div> </div> <div style="margin-top: 5px;"> Press SET key </div> <div style="display: flex; justify-content: space-between;"> <div>Communication protocol 通訊協定選擇</div> <div>rS 0</div> </div> <div style="margin-top: 5px;"> Press SET key </div> <div style="display: flex; justify-content: space-between;"> <div>Communication speed 通訊速率選擇</div> <div>bPS 192</div> </div> <div style="margin-top: 5px;"> Press SET key </div> <div style="display: flex; justify-content: space-between;"> <div>Data configuration 資料結構選擇</div> <div>bIt 8N1</div> </div> <div style="margin-top: 5px;"> Press SET key </div> </div>	-200 ~ 9999	
	1 ~ 255	1> Range: 1~255
	0 ~ 1	1> 「rs=0」 : Modbus-RTU 2> 「rs=1」 : Modbus-ASCII
	96 / 192 / 384	1> 「bPS =96」 : 9600 bps 2> 「bPS =192」 : 19200 bps 3> 「bPS =384」 : 38400 bps
	8N1 / 8O1 / 8E1 8N1 / 7O1 / 7E1	1> 「bIt =8N1」 : 8 bit non parity 2> 「bIt =8O1」 : 8 bit odd parity 3> 「bIt =8E1」 : 8 bit even parity 4> 「bIt =8N2」 : 8 bit non parity 5> 「bIt =7O1」 : 7 bit odd parity 6> 「bIt =7E1」 : 7 bit even parity

Setting of parameter / 參數設定

Function	Range	Description
Control status 控制狀態	8888	-200 ~ 9999
Press [F] key ↓ 3 sec		
Cycle time 動作週期	Ct 15	0 ~ 99
Press [SET] key ↓		
Auto tuning 自動演算	At 0	0 ~ 1
Press [SET] key ↓		
Auto tuning bias 自動演算偏差值	tu 0	0 ~ 99
Press [SET] key ↓		
Proportion band 比例帶	P 10	0 ~ 3999
Press [SET] key ↓		
Integral time 積分時間	I 120	0 ~ 3999
Press [SET] key ↓		
Derivative time 微分時間	d 30	0 ~ 3999
Press [SET] key ↓		
Hysteresis 動作應差	Hys 1	0 ~ 99
Press [SET] key ↓		
Gain 輸出控制增益	GAn 1.0	0.1~9.9
Press [SET] key ↓		
Input selecting 輸入選擇	Int k	PT / K / J / R / S T / B / E / N / L
Press [SET] key ↓		
Unit selecting 單位選擇	Unt C	°C / °F
Press [SET] key ↓		
Decimal point selecting 小數點選擇	dp 0	0 / 1
Press [SET] key ↓		
Input shift setting 輸入修正	Sht 0	-999 ~ 9999
Press [SET] key ↓		
Control method setting 控制方式	H_C Htr	Htr / cLr
Press [SET] key ↓		
Alarm mode setting 警報模式	ALt 0	0 ~ 26
Press [SET] key ↓		
Display mode setting 顯示自動切換設定	Sdc n	n / A
Press [SET] key		

1> 「CT = 0」 : ON/OFF control
2> Disappeared in Linear output type

1> 「At = 0」 : Control status
2> 「At = 1」 : Auto tuning status

1> Auto tuning value = 「SV - tu」

1> 「CT = 0」 → 「P」 is disappeared

1> 「CT = 0」 → 「I」 is disappeared

1> 「CT = 0」 → 「d」 is disappeared

1> 「CT = 0」 → 「Hys」 is appeared only
2> 「PV > SV」 → Out ON ;
「PV < (SV - Hys)」 → Out OFF

1> Gain of output control

1> 10 input type are selectable

1> 「dp = 0」 : Without decimal point
2> 「dp = 1」 : One decimal point

1> 「PV」 = (PV + Sht)

1> 「Htr」 : Heating control
2> 「cLr」 : Cooling control

1> Refer to the mode of Alarm

1> 「n」 : Manual setting
2> 「A」 : Auto setting

Fuzzy + PID Intelligent Temperature Controller

Setting of alarm / 警報設定

Function	Range	Description
Control status 控制狀態 8888	0 ~ 9999	
Press SET & F key ↓ 3 sec		
Lock setting 鎖定設定 Lck 0	0 ~ 3	1> 「Lck=0」: Unlock ; Lck=1」: SV settable only 「Lck=2」: SV&AL settable ; 「Lck=3」: All lock
Press SET		
AL1 Limit setting AL1 警報設定 AL1 50	-999 ~ 9999	1> Refer to the mode of Alarm
Press SET		
AL2 Limit setting AL2 警報設定 AL2 50	-999 ~ 9999	1> Refer to the mode of Alarm
Press SET		
Hysteresis of alarm 警報應差值設定 ALH 1	0 ~ 9999	Ex. $PV \geq (SV + AL1) \rightarrow AL1$ ON, $PV < (SV + AL1 - ALH) \rightarrow AL1$ OFF
Press SET		
Flick timer 警報閃爍輸出時間設定 t 10	0 ~ 99	1> Range: 0~99 sec 2> Cycle time of flick timer
Press SET		
Setting limit 最大設定值限制 SLH 400	0 ~ 9999	1> $SV \leq SLH$ 2> Range of transmitter : 0~SLH→
Press SET		
Output limit 輸出量限制設定 Out 100	0 ~ 100%	1> Output volume = Control output volume * 「Out」
Press SET		
Process output volume 實際輸出量 Un 0.0	0 ~ 99.99	1> Display the output volume
Press SET		
Max. display value setting 最大顯示值設定 dSPH 1000	0 ~ 9999	1> Current or Voltage input type will be appeared only 2> Max. input value will be transmitted into the dSPH
Press SET		
Min. display value setting 最小顯示值設定 dSPL 0	-999 ~ 9999	1> Current or Voltage input type will be appeared only 2> Min. input value will be transmitted into the dSPL
Press SET		
Process current of heater 實際加熱器輸出電流值 Ctu 0.00	0 ~ 99.99	1> Range: 0.00 ~ 99.99 A
Press SET		
Heater break setting 加熱器斷線電流設定值 Hb 1.00	0 ~ 99.99	1> Range: 0.00 ~ 99.99 A 2> 「Ctu」 < 「Hb」 → AL2 ON
Press SET		
CT Low limit setting CT最小值設定 CtL 0.00	0 ~ 99.99	1> Range: -9.99 ~ 99.99 2> Offset of CT current
Press SET		
CT High limit setting CT最大值設定 CtH 30.00	0 ~ 99.99	1> Range: 0.00 ~ 99.99 2> To set the max. CT current
Press SET		
Ramp control setting 溫升速率控制 rAP 0	0 ~ 9999	1> Range: 0 ~ 9999 °C or °F / minute 2> Rap=0: Without Ramp control function
Press SET		
Min. output volume setting 最小輸出量設定 Lot 0	0 ~ 100%	1> Range: 0 ~ 100% 2> Setting of min. output volume
Press SET 3 sec		
Soft start setting 緩起動設定 SV2 0	-999 ~ 9999	1> 「SV2」 = 0: Without soft start function 2> 「PV」 < 「SV2」: output volume is fixed at manual output volume 3> 「PV」 ≥ 「SV2」: Output volume is controlled by PID
Press SET		

Mode of alarm / 警報模式【NT-□□】

Alt	Description / 警報說明	Alt	Description / 警報說明	Alt	Description / 警報說明
0		1		2	
3		4		5	
6		7		8	
9		10		11	
12		13		14	
15		16		17	
18		19	Non-used	20	
21		22		23	
24		25		26	

- 「Alt=15」: t = ON time of AL2 for cooling, OFF time is controlled by PID.
- 「ALH」: Hysteresis of alarm. Ex. $PV \geq (SV+AL1) \rightarrow AL1 ON$, $PV < (SV+AL1-ALH) \rightarrow AL1 OFF$
- 「tnu」= Process time of tnr, if 「tnu ≥ tnr」 → AL2 is turned ON or OFF

Mode of alarm / 警報模式【NT-□□-CT & eTC-48 & NT-22】

Alt	Description / 警報說明	Alt	Description / 警報說明	Alt	Description / 警報說明
0		1		2	
3		4		5	
6		7		8	
9		10		11	

- 「Alt = 11」: t = ON time of AL for cooling, OFF time is controlled by PID.
- 「ALH」: Hysteresis of alarm. Ex: $PV \geq (SV+AL1) \rightarrow AL1 ON$; $PV < (SV+AL1-ALH) \rightarrow AL1 OFF$
- NT-22□-CT: HB alarm output is AL1
- NT-48□-CT: HB alarm output is AL2

Fuzzy + PID Intelligent Temperature Controller

NT series

UL US / CE / RoHS

www.fotek.com.tw

Connection diagram / 接線圖

NT - 22-□□

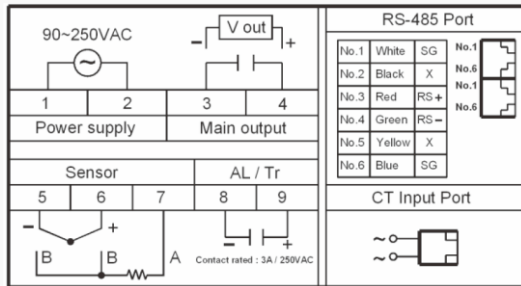

NT - 32-□□

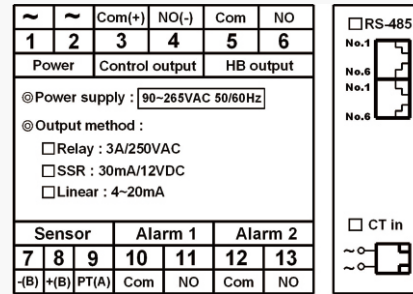

NT - 10-□□

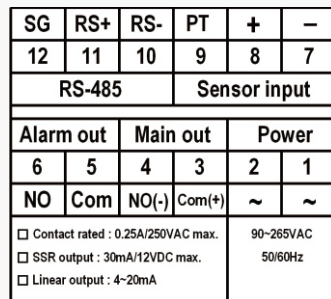

NT - 48-□□

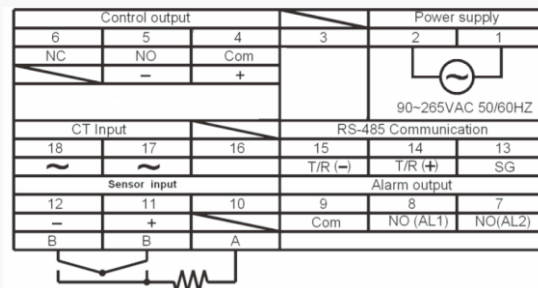

NT - 20-□□

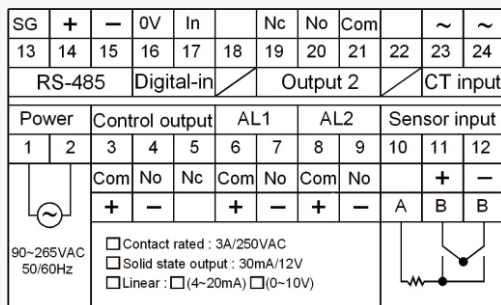

NT - 21-□□

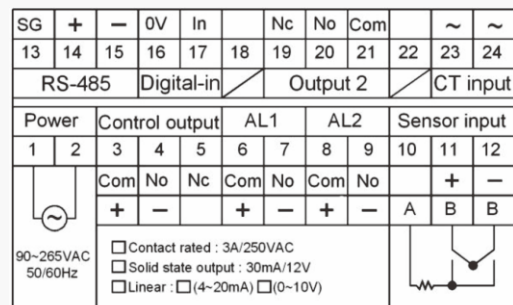

NT - 72-□□E

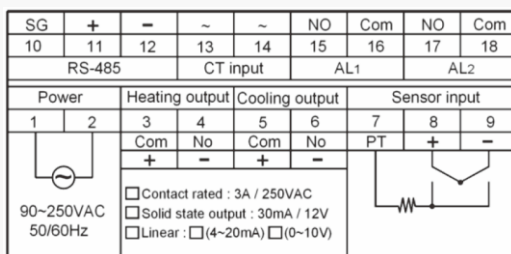

NT - 96-□□E

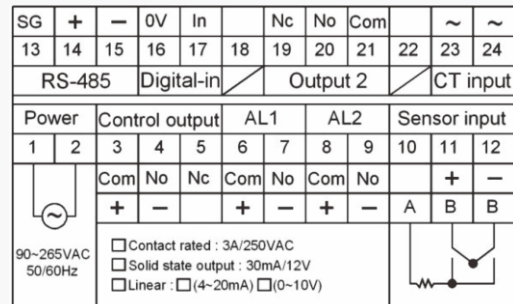

Attachment / 附件

CT-06: Load current 10 A max

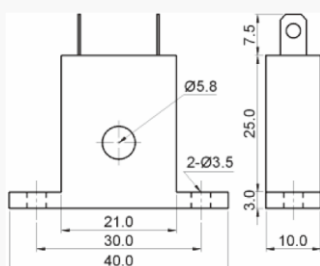

CT-09: Load current 30 A max.

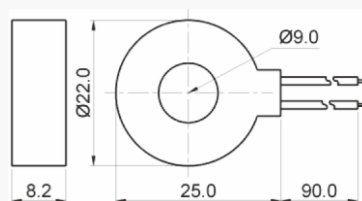

CT-100: Load current 100 A max.

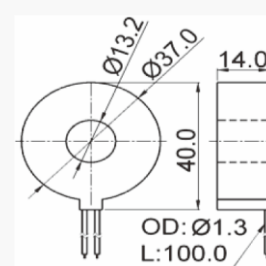

Outline dimension / 外形圖

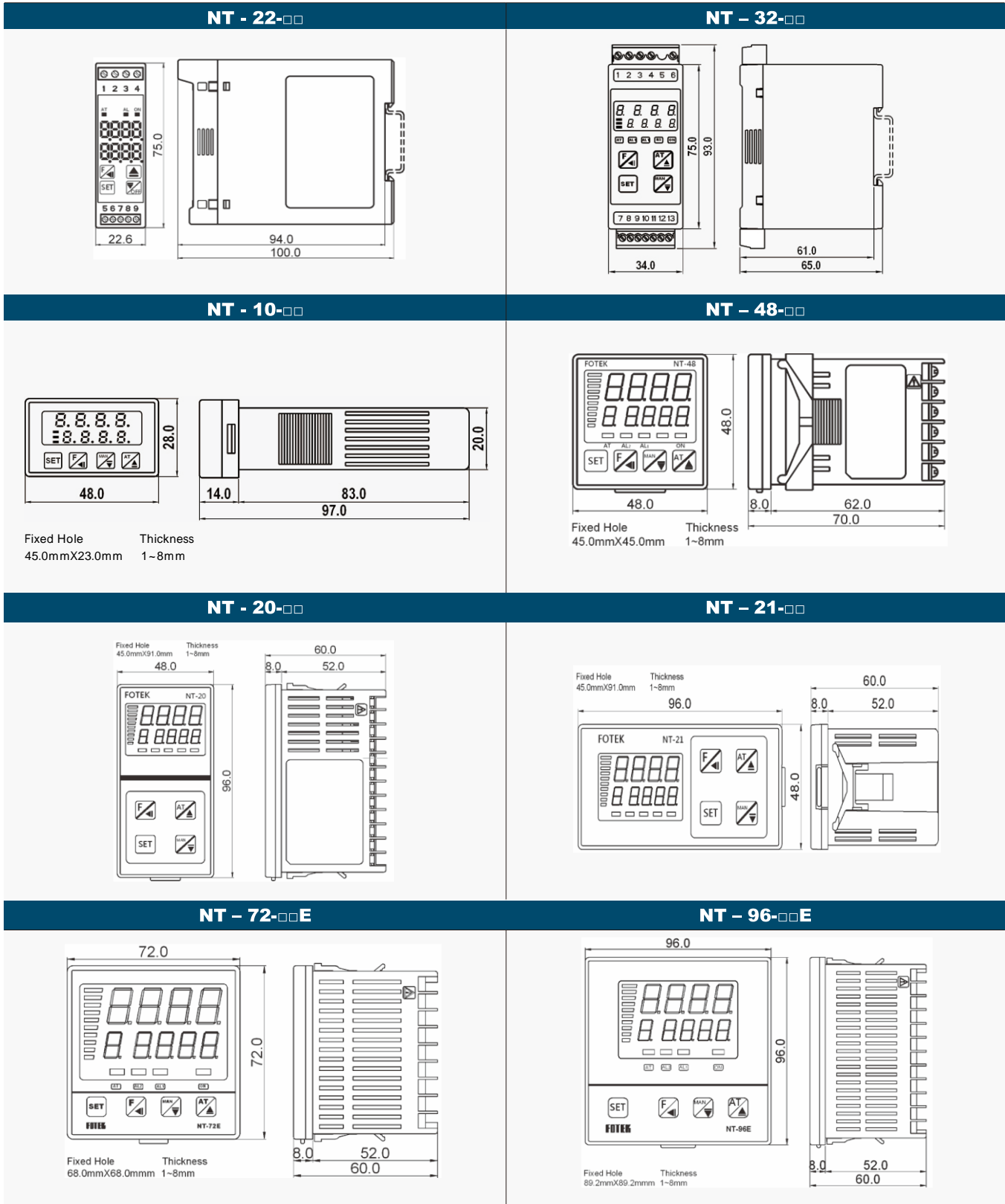

Specification may be modified without notice in advance. (2015/5/5)