

SPINNER

Air Traffic Control



Superior Rotary Joints for ATC

Edition C.1/2023

HIGH FREQUENCY PERFORMANCE WORLDWIDE
www.spinner-group.com



Custom-made rotary joints

For an enquiry to a custom-made rotary joint, our specification sheet assists you defining your system. Please find it at the end of this catalogue on page 38.

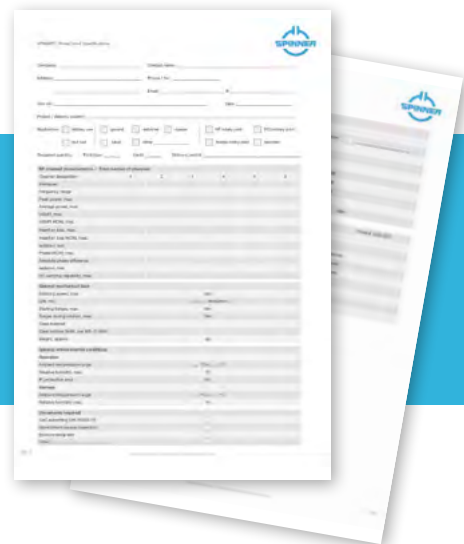

For more information on products, please use our Product Finder at products.spinner-group.com



You can get the latest new edition of our ATC catalogue in the download section of our website. Please follow this link: www.spinner-group.com/downloads

The specifications given here as well as the illustrations are for information. They shall only be confirmed by SPINNER's written offer and are subject to technical amendments.

© 2020 SPINNER



Content

Technologies	4
Plug & Play Slip Rings and Fiber Optic Solutions	6
Contactless Data and Power Transmission.....	8
General Conditions.....	9
Rotary Joint Modules	10
L-Band Rotary Joint Modules	10
S-Band Rotary Joint Modules.....	12
Rotary Joints	14
3 Channel Rotary Joints.....	14
4 Channel Rotary Joints.....	21
6 Channel Rotary Joints.....	22
7 Channel Rotary Joints.....	28
8 Channel Rotary Joint.....	34
9 Channel Coax Rotary Joint	35
RF and Fiber Optic Rotary Joints.....	36
Rotary Joint & Slip Ring Specification.....	38
Technical Annex	42

Don't Stop Spinning! RF Rotary Joints for Air Traffic Surveillance Radar Systems



Aviation volumes have been growing steadily for decades, and the requirements for monitoring the airspace around and between airports have also been increasing as a result. Today's high air traffic densities can only be managed with the aid of extremely reliable components that fully exploit the potential of digitization.

The new RF rotary joints from SPINNER are virtually maintenance-free when equipped for contactless transmission of data and power. Their features include real-time gigabit Ethernet for handling the steadily expanding data volumes involved.

They are also well-known for the exceptionally high quality and precision of their mechanical parts and their excellent signal transmission properties.

SPINNER RF Rotary Joints

RF rotary joints play key roles in all radar systems in which signals are transmitted between a static platform and a constantly rotating antenna.

They include air traffic control (ATC) systems such as surface movement radar (SMR), precision approach radar (PAR), air surveillance radar (ASR), en-route radar, and Doppler weather radar (DWR).

Besides high-quality mechanical parts, the performance of RF rotary joints depends on three main factors:

- Signal transmission quality
- The length of maintenance-free duty cycles
- The data handling approach used

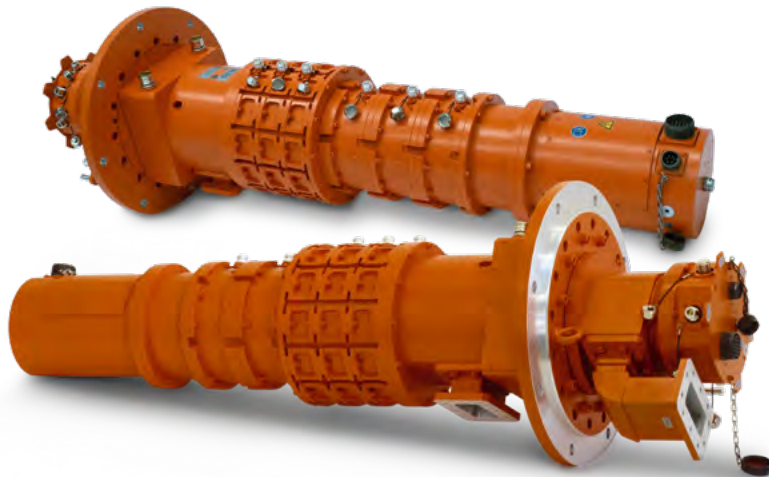

Uncompromisingly high-quality mechanical parts

All previous RF rotary joint versions from SPINNER have also excelled with compact designs, exceptionally low transmission fluctuations, and high crosstalk attenuation between individual channels across the entire frequency range, among other things.

All this is additionally supported by very precisely machined waveguides for the primary radar signals and proven L-band coaxial channels for the secondary radar.

They are reliably calculated and designed to ensure exceedingly long-term, maintenance-free service, also with nonstop operation at full load under harsh environmental conditions.

RF rotary joints from SPINNER let radar systems achieve their full detection range without any downsides.



Comprehensive service for rotary joints of all makes

As an additional service, SPINNER repairs and maintains all brands of ATC rotary joints. Our engineers' extensive experience with RF rotary joints in both civilian and military applications, backed by our commitment to continuous product improvement, is the basis of our remarkable success. All major European air traffic control organizations now rely on our components.

Plug and Play Slip Ring



SPINNER has developed a **special maintenance approach** that eliminates the need to remove the entire coupling for servicing or replacement. Instead, the

transmission unit is designed for easy removal in a few simple steps – making it a **“plug & play” slip ring system.**

For special high-performance applications, SPINNER also offers even faster data transmission via fiber-optic rotary joints.

Fiber Optic Technologies

We supply combinations of fiber optic rotary joints with radio frequency (RF) rotary joints, contactless power transmission modules, slip rings, multi-media joints and

contactless data transmission. Our specialties also include integrated data and power transmission solutions with a small form factor.



Two clean rooms with 18 and 100 m² of space are available

Fiber Optic Technologies

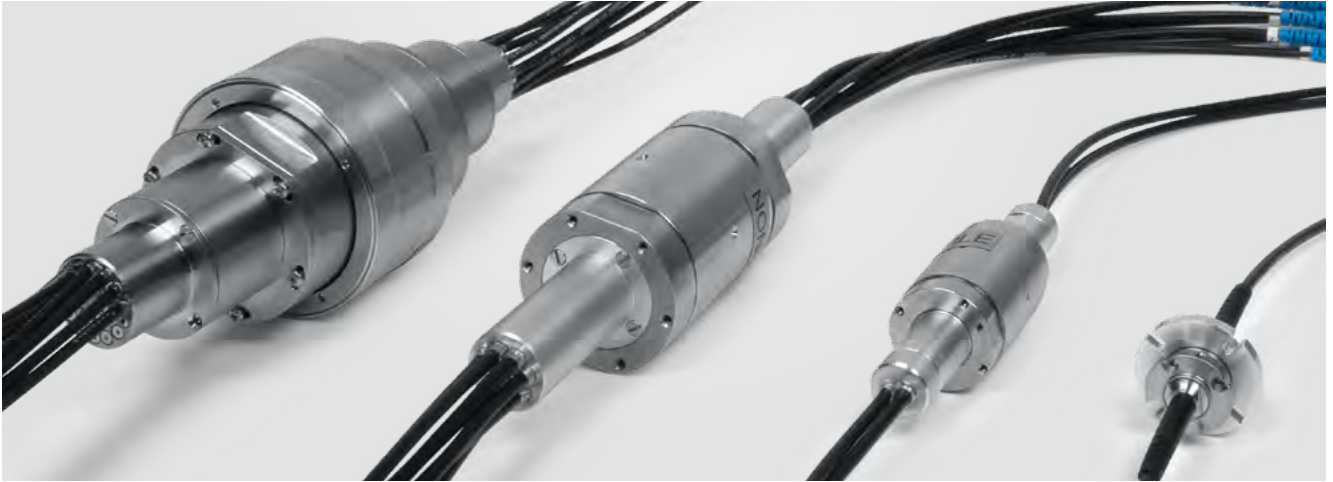

Optical Performance Parameters

- Low insertion loss
- High return loss values
- Low variation while rotating
- Mixed Single Mode and Multi Mode fibers in one unit

Optical Parameter Tracking While Rotating

- Narrow insertion loss band across all channels of a multi-channel fiber optic rotary joint
- Multi-channel fiber optic rotary joints provide excellent phase stability

SPINNER multi-channel rotary joints use a dove prism to derotate images arriving via the input fiber for coupling with the output fiber. For up to 81 channels, SPINNER relies on discretely mounted collimators for the individual light propagation paths instead of an optical lens array.

This technology makes it possible to individually adjust and optimize the insertion loss values of each optical fiber channel. The result is superior tracking performance of optical channels during rotation.

Fiber Types

- Single-mode E9/125 μm (OS1, OS2)
- Multi-mode G50/125 μm , also G62.5/125 μm (OM1-OM4)
- Special fibers, e.g. for low bending radiuses or large-core fibers

Environmental Conditions

- IP code protection for harsh environmental conditions
- High-temperature capability for implementation in RF systems
- Hydrostatic pressure capability for deep-sea applications

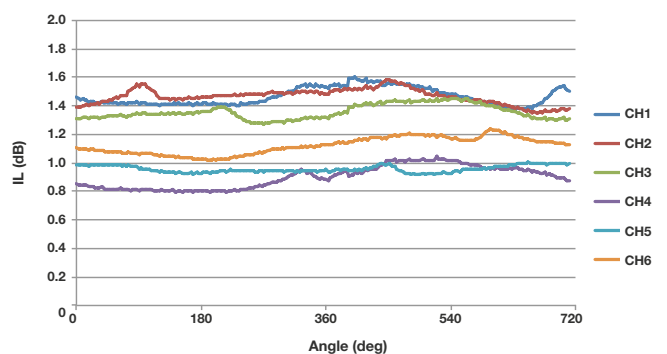

Data and Power Transmission

Virtually maintenance-free when required

New rotary couplings for contactless data and power transmission are virtually maintenance-free. They replace the slip rings that would otherwise be required.

Conventional slip rings involve physical contact and are therefore subject to wear inside the housing, which can impair transmission in the overall system. Due to these mechanical stresses, they also need to be replaced or serviced relatively often. By comparison, contactless transmission greatly prolongs the usual maintenance intervals.

Real-time transmission via GB Ethernet

Contactless real time and full band data transmission

Contactless rotary couplings from SPINNER feature real-time data transmission that complies with the Profinet Class C Ethernet protocol. These contactless units leverage the full bandwidth of standard Ethernet components that have proven themselves in practice millions of times, resulting in absolutely reliable data transmission in real time.



Data transmission module



Data transmission rotary joint with 100 mm clear inner diameter



Power transmission module

Universal 100 Mbit/s Ethernet rotary joint for real time industrial applications

- POWERLINK
- EtherCAT
- PROFINET CC-A, CC-B, CC -C (IRT-Isochronous **real time**)
- Bluecom
- Sercos III
- VARAN
- EtherNet/IP
- DRIVE-CLiQ
- IEEE 1588 v2 (PTP)

Ethernet rotary joint for up to 1Gbit/s, IEE 802.3

- Automatic setting of speed and duplex mode 10/100/1000 Mbit/s (auto-negotiation)
- CC-Link

Others

- CAN 500 kbit/s (repeater mode)
- PROFIBUS 500 kbit/s (12 Mbit/s)

360°

5,000 rpm

The benefits of the new RF rotary joints from SPINNER at a glance

- Virtually maintenance-free, due to contactless transmission of data and power
- Optionally: slip ring transmission with a significantly improved maintenance approach (plug & play slip rings)
- Real-time data transmission via gigabit Ethernet with the full bandwidth (Profinet Class C Ethernet protocol)
- Optionally: data transmission via fiber-optic cable (single- and multimode-capable, up to 81 channels)
- Proven standardized L-band coaxial channels for secondary radar signals
- Overall excellent mechanical quality and outstanding signal transmission

General Conditions

Environmental Conditions

SPINNER ATC rotary joints can be supplied for any specified operating and storage temperatures.

Operation	
Ambient temperature range	-40 °C to +71 °C (unless otherwise specified)
Relative humidity, max.	95% (non-condensing)
Storage	
Ambient temperature range	-55 °C to +85 °C
Relative humidity, max.	95% (non-condensing)

Rotational Speed

Depending on customer requirements, the rotational speed can vary between 5 and 60 rpm. Other speeds are on request.

Protection

The rotary joints come with IP50 for interior installations or IP65 for outside use, and their main material is aluminum alloy with a chromate conversion coating as per MIL-DTL-5541 type 1 or 2 in any RAL color.

Maintenance

The overall service life of the RF components is about 200×10^6 revolutions. If a slip ring is integrated, maintenance is required after between 12.5 and 25 million revolutions.

A completely contactless solution with contactless power and data transmission eliminates the need for servicing.

Alternatively, a plug & play slip ring can be installed for quick and easy on-site maintenance.

L-Band Rotary Joint Modules



LBE1 module with 1 channel

LBE1 module with 2 channels

LBE1 module with 3 channels

Radio Frequency Characteristics

Module type	LBE1	LBE2	LBE3
Interface type	N-f (50 Ω)		
Frequency range	1.0 to 1.12 GHz	1.2 to 1.4 GHz	0.95 to 1.15 GHz
No. of channels	stackable 1 to 3		
Peak power rating	10 kW		
Average power rating	300 W @ usage of UT250 semi-rigid cable 100 W @ usage of UT141 semi-rigid cable		
VSWR, max.	1.3	1.3	1.25
VSWR variation over rotation, max.	0.1		
Insertion loss, max.	0.4 dB caused by rotary joint + 0.30 dB/m @ usage of UT250 semi-rigid cable 0.45 dB/m @ usage of UT141 semi-rigid cable		0.3 dB caused by rotary joint +
Insertion loss variation over rotation, max.	0.1 dB		
Phase variation over rotation, max.	2 deg.		1 deg.
Isolation, min. / typ.	50 dB / 60 dB		60 dB / 70 dB

Mechanical Characteristics

Free inner bore (excluding connectors & cable)	70 mm	30 mm
Life, min.	200 x 10 ⁶ revolutions	
IP protection level	IP40	
Weight, approx.	3 kg each module (without cables)	

L-Band Rotary Joint Modules

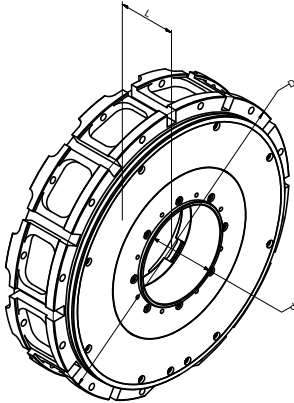

Module LBE1 and LBE2

Number of Channels	1	2	3
D	214 mm	214 mm	214 mm
d	70 mm	70 mm	70 mm
L	45.3 mm	90.6 mm	135.9 mm

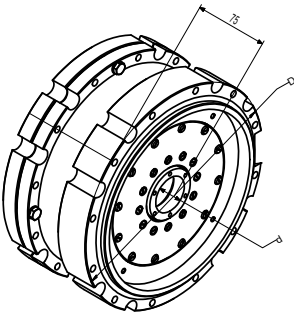

Module LBE3

Number of Channels	1	2	3
D	150 mm	150 mm	150 mm
d	30 mm	30 mm	30 mm
L	70.05 mm	140.1 mm	210.15 mm

Configuration Codes for L-Band Type

6350LB	Ex	-	x	-	xC	-	xx0	-	xx	-	xx	Options	
												Cable length 1	0 RC-version xx length in mm
												Cable length 2	0 RC-version xx length in mm
												Average power, max	100 100 W 300 300 W
												Housing connector version	RC radial N-f connector AC axial cable with N-f connector
												No. of channels	1 1 channel 2 2 channels 3 3 channels
												Part No.	E1 1.0 to 1.12 GHz-version E2 1.20 to 1.40 GHz-version E3 0.95 to 1.15 GHz-version

Example of article codes:
6350LBE1-2-RC-060-30-RC-100-0-0

S-Band Rotary Joint Modules



SBE1 module with 1 channel



SBE1 module with 2 channels



SBE1 module with 3 channels

Radio Frequency Characteristics

Module type	SBE1	SBE2
Interface type	N-f (50 Ω)	
Frequency range	2.7 to 3.1GHz	
No. of channels	stackable 1 to 3	
Peak power rating	10 kW	
Average power rating	60 W	150W @ usage of UT250 semi-rigid cable 60 W @ usage of UT141 semi-rigid cable
VSWR, max.	1.25	1.3
VSWR variation over rotation, max.	0.1	
Insertion loss, max.	0.4 dB caused by rotary joint + 0.8 dB/m @ usage of UT141 semi-rigid cable	
		0.45 dB/m @ usage of UT250 semi-rigid cable 0.80 dB/m @ usage of UT141 semi-rigid cable
Insertion loss variation over rotation, max.	0.1 dB	
Phase variation over rotation, max.	2 deg.	
Isolation, min. /typ.	60 dB / 70 dB	

Mechanical Characteristics

	13.5 mm	30 mm
Free inner bore (excluding connectors & cable)	13.5 mm	30 mm
Life, min.	200 x 10 ⁶ revolutions	
IP protection level	IP40	
Weight, approx.	2.3 kg each module (without cables)	3 kg each module (without cables)

S-Band Rotary Joint Modules

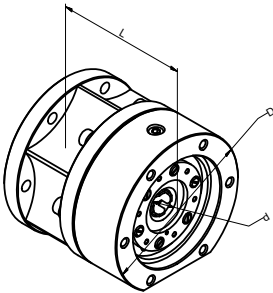

Module SBE1

Number of Channels	1	2	3
D	89 mm	89 mm	89 mm
d	13.5 mm	13.5 mm	13.5 mm
L	89.85 mm	179.7 mm	269.55 mm

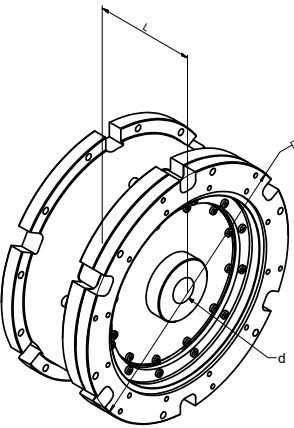

Module SBE2

Number of Channels	1	2	3
D	173 mm	173 mm	173 mm
d	30 mm	30 mm	30 mm
L	74 mm	148 mm	222 mm

Configuration Codes for S-Band Type

6350SB	Ex	-	x	-	xC	-	xx0	-	xx	-	xx	Options	
												Cable length	0 RC-version xx length in mm (only E2)
												Cable length	xx length in mm
												Average power, max.	060 60 W 150 150 W (only E2)
												Housing connector version	RC radial N-f conector AC axial cable with N-f connector
												No. of channels	1 1 channel 2 2 channels 3 3 channels
												Inner bore	E1 13.5 mm E2 30 mm

Example of article codes:
6350SBE1-2-RC-060-30-RC-060-50-0

3 Channel Coax Rotary Joint | L-Band

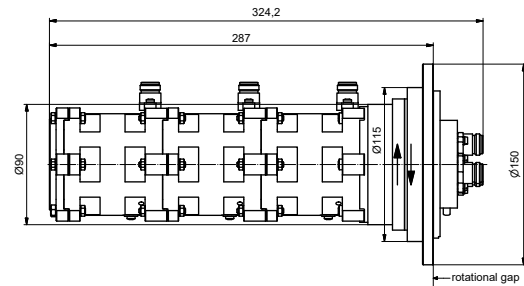

Radio Frequency Characteristics

Channel designation	Channel 1	Channel 2	Channel 3
Interface type	N-f (50 Ω)		
Frequency range	1.0 to 1.1 GHz		
Peak power rating	15 kW @ 0 m / 5 kW @ 5,000 m		
Average power rating	300 W	75 W	
VSWR, max. / typ.	1.3 / 1.2		
VSWR variation over rotation, max. / typ.	0.12 / 0.08		
Insertion loss, max.	0.5 dB / 0.4 dB	0.8 dB / 0.6 dB	
Insertion loss variation over rotation, max. / typ.	0.1 dB / 0.05 dB		
Phase variation over rotation, max. / typ.	2.5 deg. / 1.8 deg.		
Isolation, min.	50 dB		

Mechanical Characteristics

Life, min.	200 x 10 ⁶ revolutions		
IP protection level	IP65		
Weight, approx.	6 kg		

3 Channel Coax Rotary Joint | L-Band

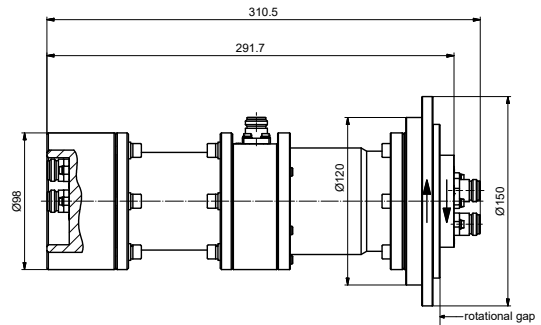

Radio Frequency Characteristics

Channel designation	Channel 1	Channel 2	Channel 3
Interface type	N-f (50 Ω)		
Frequency range	0.95 to 1.2 GHz		
Peak power rating	15 kW		
Average power rating	300 W	50 W	50 W
VSWR, max. / typ.	1.25 / 1.20		
VSWR variation over rotation, max. / typ.	0.10 / 0.05		
Insertion loss, max.	0.4 dB / 0.3 dB	0.5 dB / 0.4 dB	
Insertion loss variation over rotation, max. / typ.	0.1 dB / 0.05 dB		
Phase variation over rotation, max. / typ.	2 deg. / 1 deg.		
Isolation, min.	60 dB / 75 dB		

Mechanical Characteristics

Life, min.	200 x 10 ⁶ revolutions
IP protection level	IP60
Weight, approx.	8 kg

3 Channel Coax Rotary Joint | L-Band

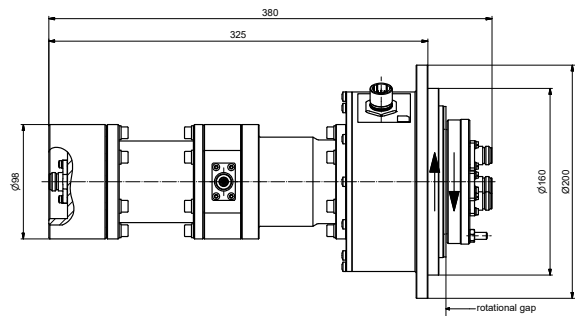

Radio Frequency Characteristics

Channel designation	Channel 1	Channel 2	Channel 3
Interface type	N-f (50 Ω)		
Frequency range	0.95 to 1.20 GHz		
Peak power rating	15 kW		
Average power rating	300 W	100 W	100 W
VSWR, max. / typ.	1.25 / 1.20		
VSWR variation over rotation, max. / typ.	0.10 / 0.05		
Insertion loss, max. / typ.	0.4 dB / 0.3 dB	0.5 dB / 0.4 dB	0.5 dB / 0.4 dB
Insertion loss variation over rotation, max. / typ.	0.1 dB / 0.05 dB		
Phase variation over rotation, max. / typ.	2 deg. / 1 deg.		
Isolation, min. / typ.	60 dB / 75 dB		

Encoder Characteristics

Type	Single or dual encoder on request
------	-----------------------------------

Mechanical Characteristics

Life, min.	200 x 10 ⁶ revolutions
IP protection level	IP65
Weight, approx.	11 kg

3 Channel Coax Rotary Joint | L-Band

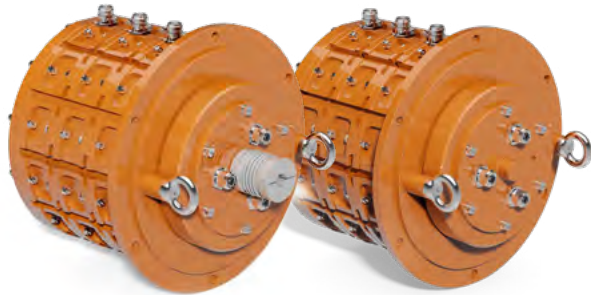

Option bellow and encoder with cable

Option driving pin and encoder with connector

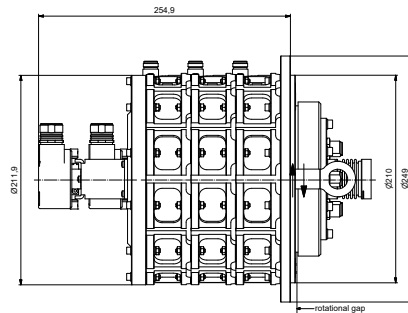

Radio Frequency Characteristics

Channel designation	Channel 1	Channel 2	Channel 3
Interface type	N-f (50 Ω)		
Frequency range	1.0 to 1.1 GHz		
Peak power rating	15 kW @ 0 m / 5 kW @ 5,000 m		
Average power rating	300 W		
VSWR, max. / typ.	1.3 / 1.2		
VSWR variation over rotation, max. / typ.	0.10 / 0.05		
Insertion loss, max.	0.5 dB		
Insertion loss variation over rotation, max.	0.05 dB		
Phase variation over rotation, max.	2 deg.		
Isolation, min.	60 dB		

Encoder Characteristics

Type	Single or dual encoder on request
------	-----------------------------------

Mechanical Characteristics

Life, min.	200 x 10 ⁶ revolutions
IP protection level	IP40
Weight, approx.	17 kg

3 Channel Coax Rotary Joint | L-Band

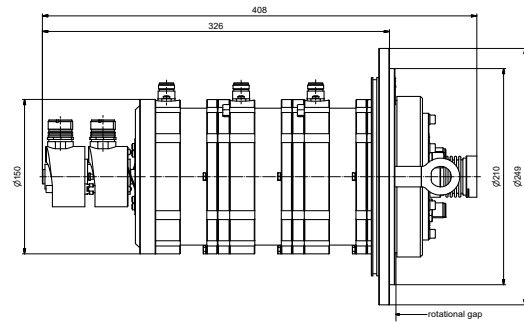

Radio Frequency Characteristics

Channel designation	Channel 1	Channel 2	Channel 3
Interface type	N-f (50 Ω)		
Frequency range	1.0 to 1.1 GHz		
Peak power rating	15 kW @ 0 m / 5 kW @ 5,000 m		
Average power rating	300 W		
VSWR, max. / typ.	1.25 / 1.20		
VSWR variation over rotation, max. / typ.	0.10 / 0.05		
Insertion loss, max.	0.5 dB		
Insertion loss variation over rotation, max.	0.05 dB		
Phase variation over rotation, max.	2 deg.		
Isolation, min.	60 dB		

Encoder Characteristics

Type	Single or dual encoder on request
------	-----------------------------------

Mechanical Characteristics

Life, min.	200 x 10 ⁶ revolutions
IP protection level	IP65 on top side / IP43 on bottom side
Weight, approx.	14 kg

3 Channel Waveguide Coax Rotary Joint | S-Band

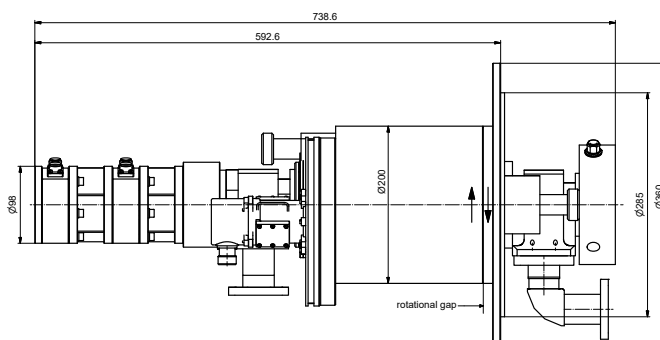

Radio Frequency Characteristics

Channel designation	Channel 1	Channel 2	Channel 3
Interface type	WR284	N-f (50 Ω)	N-f (50 Ω)
Frequency range	2.7 to 2.9 GHz		
Peak power rating	35 kW	10 kW	
Average power rating	3000 W	75 W	
VSWR, max. / typ.	1.2	1.3 / 1.2	
VSWR variation over rotation, max. / typ.	0.05	0.10 / 0.05	
Insertion loss, max.	0.15 dB	0.9 dB	
Insertion loss variation over rotation, max. / typ.	0.05 dB	0.1 dB / 0.05 dB	
Phase variation over rotation, max. / typ.	2 deg. / 1 deg.	2.5 deg. / 1.5 deg.	
Isolation, min.	60 dB		

Encoder Characteristics

Type	Single or dual encoder on request
------	-----------------------------------

Slip Ring Characteristics

Total number of ways	20
----------------------	----

Mechanical Characteristics

Differential operating pressure, max. / nom.	1 bar / 0.5 bar
Leakage rate, max.	25 cm ³ / minute
Life, min.	40 x 10 ⁶ revolutions
IP protection level	IP65
Weight, approx.	37 kg

3 Channel Waveguide Coax Rotary Joint | S-Band

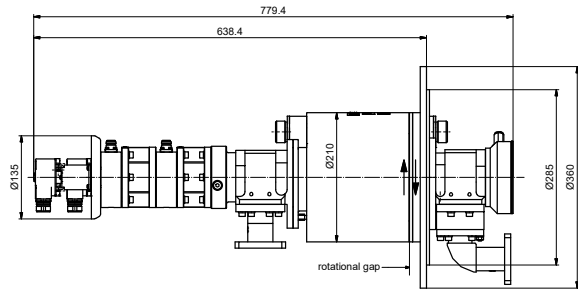

Radio Frequency Characteristics

Channel designation	Channel 1	Channel 2	Channel 3
Interface type	WR 284	N-f (50 Ω)	
Frequency range	2.7 to 2.9 GHz		
Peak power rating	200 kW	10 kW	
Average power rating	3500 W	75 W	
VSWR, max.	1.2	1.25	
VSWR variation over rotation, max.	0.05	0.05	
Insertion loss, max.	0.15 dB	0.9 dB	
Insertion loss variation over rotation, max.	0.03 dB	0.03 dB	
Phase variation over rotation, max.	1.5 deg.	2 deg.	
Isolation, min.	70 dB	60 dB	

Encoder Characteristics

Type	Single or dual encoder on request
------	-----------------------------------

Slip Ring Characteristics

Total number of ways	15
----------------------	----

Mechanical Characteristics

Differential operating pressure, max./nom.	1 bar / 0.5 bar
Leakage rate, max.	25 cm ³ / minute
Life, min.	40 x 10 ⁶ revolutions
IP protection level	IP65
Weight, approx.	35 kg

4 Channel Coax Rotary Joint | L-Band

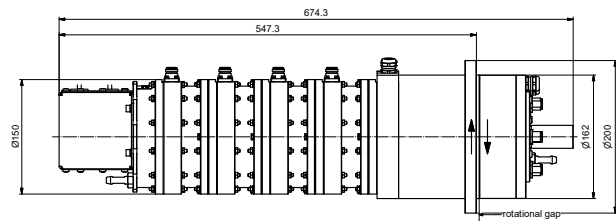

Radio Frequency Characteristics

Channel designation	Channel 1	Channel 2	Channel 3	Channel 4
Interface type	N-f (50 Ω)			
Frequency range	1.215 to 1.4 GHz			
Peak power rating	5 kW			
Average power rating	50 W			
VSWR, max. / typ.	1.3 / 1.2			
VSWR variation over rotation, max. / typ.	0.10 / 0.05			
Insertion loss, max.	0.5 dB			
Insertion loss variation over rotation, max. / typ.	0.1 dB / 0.05 dB			
Phase variation over rotation, max. / typ.	2.5 deg. / 1.5 deg.			
Isolation, min.	60 dB			

Encoder Characteristics

Type	Single or dual encoder on request
------	-----------------------------------

Slip Ring Characteristics

Total number of ways	14
----------------------	----

Mechanical Characteristics

Life, min.	40 x 10 ⁶ revolutions
IP protection level	IP54
Weight, approx.	20 kg

6 Channel Waveguide Coax Rotary Joint | S-Band/L-Band

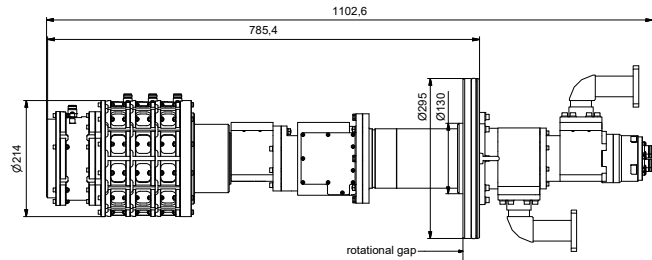

Radio Frequency Characteristics

Channel designation	Channel 1	Channel 2	Channel 3	Channel 4	Channel 5	Channel 6
Interface type	WR 284	N-f (50 Ω)				
Frequency range	2.7 to 2.9 GHz			1.0 to 1.1 GHz		
Peak power rating	100 kW			5 kW		
Average power rating	3 kW	1.2 kW	50 W	125 W		
VSWR, max. / typ.	1.2 / 1.15	1.3 / 1.2	1.3 / 1.2			
VSWR variation over rotation, max.	0.06			0.10		
Insertion loss, max. / typ.	0.15 / 0.13 dB	0.25 / 0.2 dB	0.9 / 0.75 dB	0.8 dB / 0.7 dB		
Insertion loss variation over rotation, max. / typ.	0.1 dB / 0.05 dB					
Phase variation over rotation, max. / typ.	2 deg. / 1 deg.			2.5 deg. / 1.5 deg.		
Isolation, min.	60 dB					

Mechanical Characteristics

Life, min.	200 x 10 ⁶ revolutions					
IP protection level	IP40					
Weight, approx.	60 kg					

6 Channel Waveguide Coax Rotary Joint | S-Band/L-Band

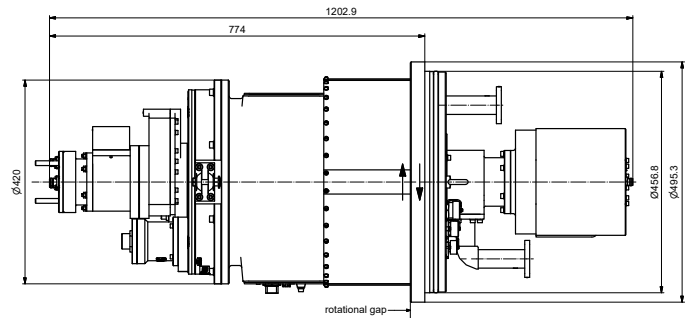

Radio Frequency Characteristics

Channel designation	Channel 1	Channel 2	Channel 3	Channel 4	Channel 5	Channel 6
Interface type	WR 284			N-f (50 Ω)		
Frequency range	2.7 to 2.9 GHz			1.0 to 1.1 GHz		
Peak power rating	100 kW				5 kW	
Average power rating	5 kW	500 W	25 W	300 W	75 W	
VSWR, max. / typ.	1.2			1.3 / 1.2		
VSWR variation over rotation, max.	0.05			1.0 / 0.05		
Insertion loss, max.	0.15 dB	0.25 dB	0.4 dB	0.6 dB		
Insertion loss variation over rotation, max. / typ.	0.05 dB	0.1 dB / 0.05 dB				
Phase variation over rotation, max. / typ.	2 deg. / 1 deg.			2.5 deg. / 1.5 deg.		
Isolation, min.	60 dB					

Encoder Characteristics

Type	Single or dual encoder on request
------	-----------------------------------

Slip Ring Characteristics

Number of ways	25
----------------	----

Mechanical Characteristics

Life, min.	200 x 10 ⁶ revolutions
IP protection level	IP65 above flange / IP54 below flange
Weight, approx.	155 kg

6 Channel Waveguide Coax Rotary Joint | S-Band/L-Band

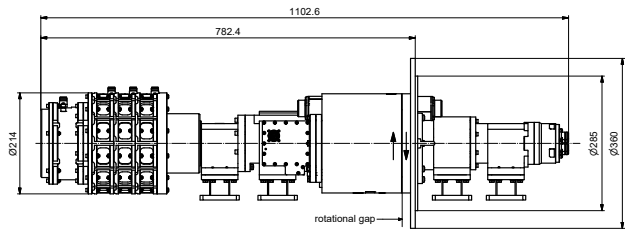

Radio Frequency Characteristics

Channel designation	Channel 1	Channel 2	Channel 3	Channel 4	Channel 5	Channel 6
Interface type	WR 284	N-f (50 Ω)				
Frequency range	2.7 to 2.9 GHz			1.0 to 1.1 GHz		
Peak power rating	100 kW	50 kW	5 kW			
Average power rating	3 kW	1.2 kW	50 W	125 W		
VSWR, max. / typ.	1.2 / 1.15	1.3 / 1.2	1.3 / 1.2			
VSWR variation over rotation, max.	0.06			0.10		
Insertion loss, max. / typ.	0.15 / 0.13 dB	0.25 / 0.2 dB	0.9 / 0.75 dB	0.8 dB / 0.7 dB		
Insertion loss variation over rotation, max. / typ.	0.1 dB / 0.05 dB					
Phase variation over rotation, max. / typ.	2 deg. / 1 deg.			2.5 deg. / 1.5 deg.		
Isolation, min.	60 dB					

Encoder Characteristics

Type	Single or dual encoder on request
------	-----------------------------------

Slip Ring Characteristics

Total number of ways	20
----------------------	----

Mechanical Characteristics

Differential operating pressure, max. / nom.	2 bar / 1 bar
Leakage rate, max.	25 cm ³ / minute
Life, min.	200 x 10 ⁶ revolutions
IP protection level	IP65 above flange / IP54 under flange
Weight, approx.	48 kg

6 Channel Waveguide Coax Rotary Joint | S-Band/L-Band

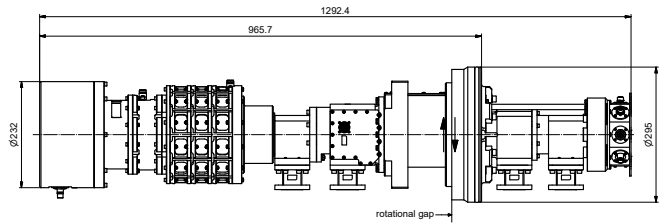

Radio Frequency Characteristics

Channel designation	Channel 1	Channel 2	Channel 3	Channel 4	Channel 5	Channel 6
Interface type	WR 284	N-f (50 Ω)				
Frequency range	2.7 to 2.9 GHz			1.0 to 1.1 GHz		
Peak power rating	100 kW	50 kW	5 kW			
Average power rating	2.5 kW	750 W	25 W	125 W	10 W	125 W
VSWR, max. / typ.	1.2 / 1.15	1.3 / 1.2	1.3 / 1.2			
VSWR variation over rotation, max.	0.06			0.1		
Insertion loss, max. / typ.	0.15 / 0.13 dB	0.25 / 0.2 dB	0.75 / 0.6 dB	0.8 / 0.65 dB		
Insertion loss variation over rotation, max. / typ.	0.1 dB / 0.05 dB					
Phase variation over rotation, max. / typ.	2 deg. / 1 deg.			2.5 deg. / 1.5 deg		
Isolation, min.	60 dB					

Encoder Characteristics

Type	Single or dual encoder on request
------	-----------------------------------

Ethernet Characteristics

100BASE-TX ethernet channel	2 signal channels over 1 contactless transmission channel, signals multiplexed, no redundancy, real-time protocols
-----------------------------	--

Contactless DC Power Transmission Channel Characteristics

Input Voltage	20.4 V - 28.8 V DC
Output power, peak / nom.	150 W / 100 W

Mechanical Characteristics

Differential operating pressure, max.	0.4 bar
Leakage rate, max.	25 cm ³ / minute
IP protection level	IP65
Weight, approx.	75 kg

6 Channel Waveguide Coax Rotary Joint | S-Band/L-Band

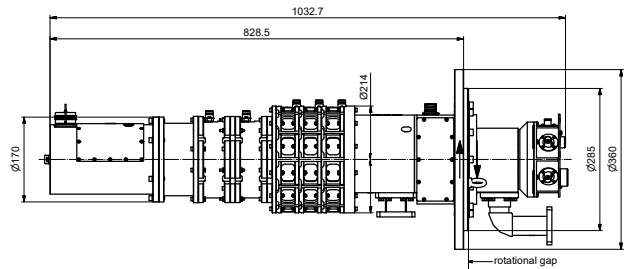

Radio Frequency Characteristics

Channel designation	Channel 1	Channel 2	Channel 3	Channel 4	Channel 5	Channel 6
Interface type	WR 284	N-f (50 Ω)				
Frequency range	2.7 to 2.9 GHz			1.0 to 1.1 GHz		
Peak power rating	100 kW	5 kW				
Average power rating	3 kW	75 W	150 W	100 W		
VSWR, max.	1.2	1.25				
VSWR variation over rotation, max.	0.05					
Insertion loss, max.	0.15 dB	0.9 dB	1.0 dB	0.75 dB		
Insertion loss variation over rotation, max. / typ.	0.05 dB	0.1 dB / 0.05 dB				
Phase variation over rotation, max. / typ.	2 deg. / 1 deg.	2 deg. / 1.5 deg.				
Isolation, min.	60 dB					

Encoder Characteristics

Type	Single or dual encoder on request
------	-----------------------------------

Slip Ring Characteristics

Total number of ways	24
----------------------	----

Mechanical Characteristics

Differential operating pressure, max. / nom.	1 bar / 0.2 bar
Leakage rate, max.	25 cm ³ /minute
Life, min.	50 x 10 ⁶ revolutions
IP protection level	IP65
Weight, approx.	50 kg

6 Channel Waveguide Coax Rotary Joint | S-Band/L-Band

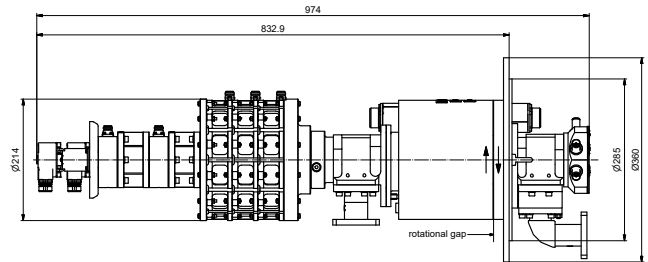

Radio Frequency Characteristics

Channel designation	Channel 1	Channel 2	Channel 3	Channel 4	Channel 5	Channel 6
Interface type	WR 284	N-f (50 Ω)				
Frequency range	2.7 to 2.9 GHz			1.0 to 1.1 GHz		
Peak power rating	100 kW	5 kW				
Average power rating	3.5 kW	75 W	150 W	100 W		
VSWR, max. / typ.	1.2 / 1.15	1.3 / 1.2				
VSWR variation over rotation, max.	0.05					
Insertion loss, max.	0.15 dB	0.9 dB		0.75 dB		
Insertion loss variation over rotation, max. / typ.	0.05 dB	0.1 dB / 0.05 dB				
Phase variation over rotation, max. / typ.	2 deg. / 1 deg.	2.5 deg. / 1.5 deg.				
Isolation, min.	60 dB					

Encoder Characteristics

Type	Single or dual encoder on request
------	-----------------------------------

Slip Ring Characteristics

Total number of ways	20
----------------------	----

Mechanical Characteristics

Differential operating pressure, max. / nom.	0.7 bar / 0.35 bar
Leakage rate, max.	25 cm ³ / minute
Life, min.	50 x 10 ⁶ revolutions
IP protection level	IP65 above flange / IP54 below flange
Weight, approx.	60 kg

7 Channel Waveguide Coax Rotary Joint | S-Band/L-Band

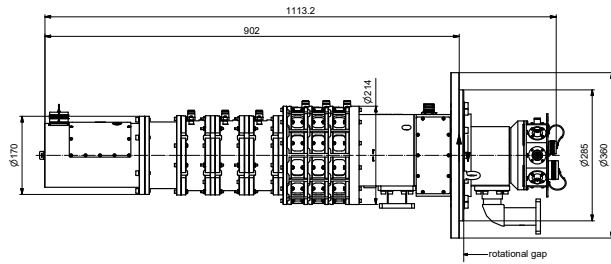
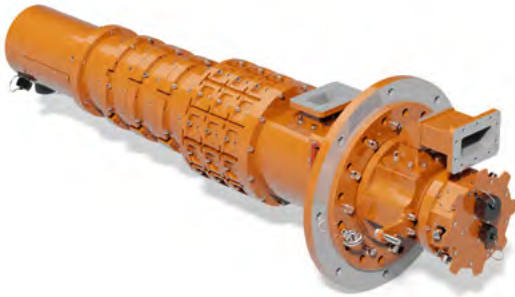

Radio Frequency Characteristics

Channel designation	Channel 1	Channel 2	Channel 3	Channel 4	Channel 5	Channel 6	Channel 7
Interface type	WR 284	N-f (50 Ω)					
Frequency range	2.7 to 2.9 GHz			1.0 to 1.1 GHz			
Peak power rating	100 kW	5 kW					
Average power rating	3 kW	60 W	150 W	100 W	60 W		
VSWR, max. / typ.	1.2 / 1.15	1.3 / 1.2					
VSWR variation over rotation, max. / typ.	0.05	0.1 / 0.05					
Insertion loss, max.	0.15 dB	1.2 dB	0.75 dB			1.2 dB	
Insertion loss variation over rotation, max. / typ.	0.05 dB	0.1 dB / 0.05 dB					
Phase variation over rotation, max. / typ.	2 deg./ 1 deg.	2.5 deg. / 1.5 deg.					
Isolation, min.	60 dB						

Encoder Characteristics

Type	Single or dual encoder on request
------	-----------------------------------

Slip Ring Characteristics

Total number of ways	24
----------------------	----

Mechanical Characteristics

Differential operating pressure, max. / nom.	0.7 bar / 0.35 bar
Leakage rate, max.	25 cm ³ / minute
Life, min.	50 x 10 ⁶ revolutions
IP protection level	IP65
Weight, approx.	63 kg

7 Channel Waveguide Coax Rotary Joint | S-Band/L-Band

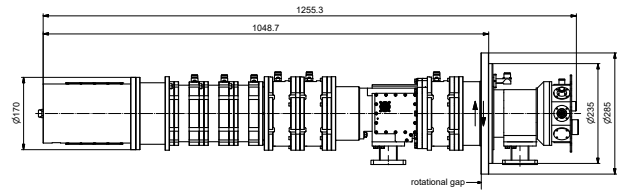

Radio Frequency Characteristics

Channel designation	Channel 1	Channel 2	Channel 3	Channel 4	Channel 5	Channel 6	Channel 7
Interface type	WR 284	N-f (50 Ω)					
Frequency range	2.7 to 2.9 GHz			1.0 to 1.1 GHz			
Peak power rating	100 kW	5 kW					
Average power rating	3 kW	75 W		300 W		75 W	
VSWR, max. / typ.	1.3 / 1.2						
VSWR variation over rotation, max.	0.05						
Insertion loss, max.	0.15 dB	0.2 dB	0.5 dB	0.75 dB			
Insertion loss variation over rotation, max.	0.15 dB	0.4 dB	0.85 dB	0.9 dB	0.5 dB	0.65 dB	
Phase variation over rotation, max.	2 deg.						
Isolation, min.	60 dB						

Encoder Characteristics

Type	Single or dual encoder on request
------	-----------------------------------

Slip Ring Characteristics

Total number of ways	19
----------------------	----

Mechanical Characteristics

Differential operating pressure, max. / nom.	2 bar / 1 bar
Leakage rate, max.	25 cm ³ / minute
Life, min.	200 x 10 ⁶ revolutions
IP protection level	IP65 above flange / IP54 below flange
Weight, approx.	70 kg

7 Channel Waveguide Coax Rotary Joint | S-Band/L-Band

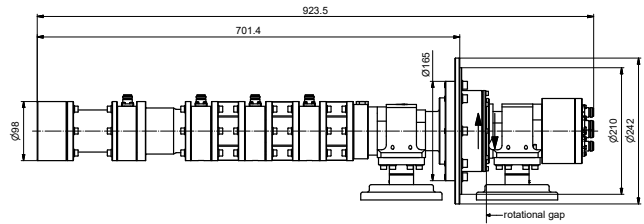

Radio Frequency Characteristics

Channel designation	Channel 1	Channel 2	Channel 3	Channel 4	Channel 5	Channel 6	Channel 7
Interface type	UG 585	N-f (50 Ω)					
Frequency range	2.7 to 3.1 GHz			1 to 1.1 GHz		2.7 to 3.1 GHz	
Peak power rating	1.5 MW *)	5 kW					
Average power rating	6 kW	50 W		300 W		50 W	
VSWR, max. / typ.	1.2	1.3 / 1.2					
VSWR variation over rotation, max. /typ.	0.05	0.1 / 0.05					
Insertion loss, max.	0.1 dB	0.7 dB					
Insertion loss variation over rotation, max. / typ.	0.05 dB	0.1 dB / 0.05 dB					
Phase variation over rotation, max. / typ.	2 deg. / 1 deg.	2.5 deg. / 1.5 deg.					
Isolation, min.	60 dB						

Mechanical Characteristics

Differential operating pressure	2.5 bar min.
Leakage rate, max.	25 cm ³ / minute
Life, min.	200 x 10 ⁶ revolutions
IP protection level	IP65
Weight, approx.	25 kg

*) Waveguide pressurized with dry air of N₂ or SF₆ at absolute pressure, min. 2.5 bar

7 Channel Waveguide Coax Rotary Joint | S-Band/L-Band

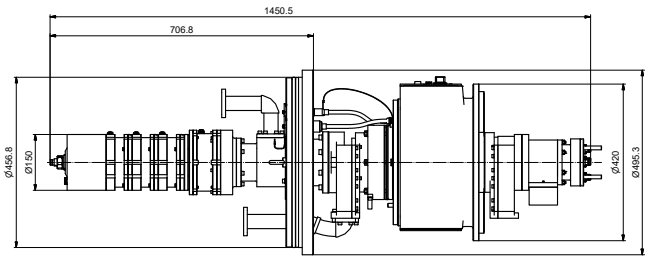

Radio Frequency Characteristics

Channel designation	Channel 1	Channel 2	Channel 3	Channel 4	Channel 5	Channel 6	Channel 7
Interface type	WR 284			N-f (50 Ω)			
Frequency range	2.7 to 2.9 GHz				1.0 to 1.1 GHz		
Peak power rating	100 kW		5 kW				
Average power rating	500 W		75 W		300 W	75 W	
VSWR, max. / typ.	1.2		1.3 / 1.2				
VSWR variation over rotation, max. / typ.	0.05		0.10 / 0.05				
Insertion loss, max.	0.15 dB	0.25 dB	0.7 dB	0.8 dB	0.6 dB		
Insertion loss variation over rotation, max. / typ.	0.05 dB		0.1 dB / 0.05 dB				
Phase variation over rotation, max. / typ.	2 deg. / 1 deg.			2.5 deg. / 1.5 deg.			
Isolation, min.	60 dB						

Encoder Characteristics

Total number of ways	Single or dual encoder on request
----------------------	-----------------------------------

Slip Ring Characteristics

Total number of ways	25
----------------------	----

Mechanical Characteristics

Differential operating pressure, max. / nom.	1 bar / 0.5 bar
Leakage rate, max.	25 cm ³ / minute
Life, min.	200 x 10 ⁶ revolutions
IP protection level	IP65 above flange / IP54 below flange
Weight, approx.	120 kg

7 Channel Waveguide Coax Rotary Joint | L-Band

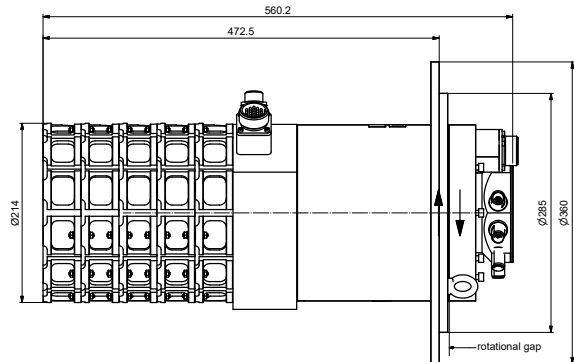

Radio Frequency Characteristics

Channel designation	Channel 1	Channel 2	Channel 3	Channel 4	Channel 5	Channel 6	Channel 7
Interface type	N-f (50 Ω)						
Frequency range	1.0 to 1.1 GHz						
Peak power rating	5 kW						
Average power rating	50 W				100 W		
VSWR, max. / typ.	1.3 / 1.2						
VSWR variation over rotation, max. / typ.	0.10 / 0.05						
Insertion loss, max. / typ.	0.85 dB / 0.75 dB				0.75 dB / 0.65 dB		
Insertion loss variation over rotation, max. / typ.	0.1 dB / 0.05 dB						
Phase variation over rotation, max. / typ.	2.5 deg. / 1.5 deg.						
Isolation, min.	60 dB						

Slip Ring Characteristics

Total number of ways	32
----------------------	----

Mechanical Characteristics

Life, min.	40 x 10 ⁶ revolutions
IP protection level	IP65
Weight, approx.	30 kg

7 Channel Waveguide Coax Rotary Joint | L-Band

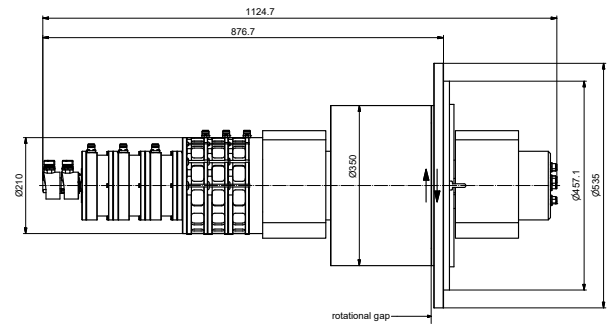

Radio Frequency Characteristics

Channel designation	Channel 1	Channel 2	Channel 3	Channel 4	Channel 5	Channel 6	Channel 7
Interface type	WR-650	N-f (50 Ω)					
Frequency range	1.2 to 1.4 GHz			1 to 1.1 GHz			
Peak power rating	400 kW	5 kW					
Average power rating	11 kW	300 W					
VSWR, max. / typ.	1.2	1.3 / 1.2					
VSWR variation over rotation, max. / typ.	0.05	0.1 / 0.05					
Insertion loss, max.	0.2 dB	0.65 dB	0.7 dB	0.75 dB	0.8 dB	0.85 dB	0.9 dB
Insertion loss variation over rotation, max. / typ.	0.05 dB	1.0 dB / 0.05 dB					
Phase variation over rotation, max. / typ.	2 deg. / 1 deg.	2.5 deg. / 1.5 deg.					
Isolation, min.	60 dB						

Encoder Characteristics

Type	Single or dual encoder on request
------	-----------------------------------

Slip Ring Characteristics

Total number of ways	21
----------------------	----

Mechanical Characteristics

Differential operating pressure, max. / nom.	2 bar / 1.4 bar
Leakage rate, max.	25 cm ³ / minute
Life, min.	50 x 10 ⁶ revolutions
IP protection level	IP65
Weight, approx.	105 kg

8 Channel Coax Rotary Joint | L-Band

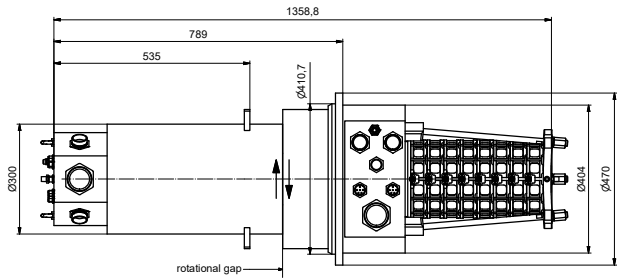

Radio Frequency Characteristics

Channel designation	Channel 1 - 3	Channel 4 - 8
Interface type	N-f (50 Ω)	
Frequency range	1.0 to 1.1 GHz	1.2 to 1.4 GHz
Peak power rating	5 kW	
Average power rating	120 W	100 W
VSWR, max. / typ.	1.30 / 1.25	
VSWR variation over rotation, max.	0.1	
Insertion loss, max.	1 dB	
Insertion loss variation over rotation, max.	0.1 dB	
Phase variation over rotation, max. / typ.	2 deg. / 1 deg.	
Isolation, min.	60 dB	

Encoder Characteristics

Type	Single or dual encoder on request
------	-----------------------------------

Slip Ring Characteristics

Total number of ways	37
----------------------	----

Media Rotary Joint Characteristics

Media / no. of channels	Dry Air / 1
-------------------------	-------------

Mechanical Characteristics

Life, min.	100 x 10 ⁶ revolutions
IP protection level	IP65 above flange / IP62 below flange
Weight, approx.	150 kg

9 Channel Coax Rotary Joint | L-Band

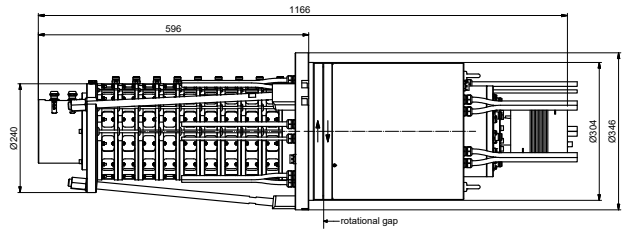

Radio Frequency Characteristics

Channel designation	Channel 1	Channel 2 – 7	Channel 8 – 9
Interface type		N-f (50 Ω)	
Frequency range	1.0 to 1.11 GHz	1.2 to 1.4 GHz	1.0 to 1.11 GHz
Peak power rating		5 kW	
Average power rating	500 W	100 W	
VSWR, max. / typ.		1.3 / 1.2	
VSWR variation over rotation, max. / typ.		0.10 / 0.05	
Insertion loss, max. / typ.	0.7 dB / 0.6 dB	0.9 dB / 0.7 dB	0.9 dB / 0.8 dB
Insertion loss variation over rotation, max. / typ.		0.1 dB / 0.05 dB	
Phase variation over rotation, max. / typ.		2.5 deg. / 1.5 deg.	
Isolation, min.		60 dB	

Encoder Characteristics

Type	Single or dual encoder on request
------	-----------------------------------

Slip Ring Characteristics

Total number of ways	35
----------------------	----

Mechanical Characteristics

Life, min.	40 x 10 ⁶ revolutions
IP protection level	IP65
Weight, approx.	120 kg

1 Channel Fiber Optic/2 Channel Coax Rotary Joint | L-Band

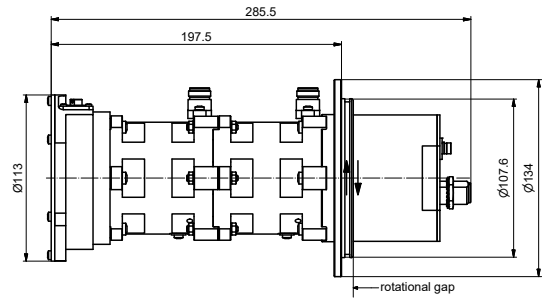

Radio Frequency Characteristics

Channel designation	Channel 1	Channel 2
Interface type	N-f (50 Ω)	
Frequency range	1.0 to 1.11 GHz	
Peak power rating	15 kW @ 0 m / 5 kW @ 5,000 m	
Average power rating	30 W	
VSWR, max. / typ.	1.3 / 1.2	
VSWR variation over rotation max. / typ.	0.12 / 0.08	
Insertion loss, max. / typ.	0.8 dB / 0.6 dB	
Insertion loss variation over rotation max. / typ.	0.1 dB / 0.05 dB	
Phase variation over rotation max. / typ.	2.5 deg. / 1.8 deg.	
Isolation, min.	50 dB	

Fiber Optic Characteristics

Number of Channels	1
Fiber type	Single mode E9 / 125µm
FO connector	FC / PC
Wavelength	1310 nm / 1550 nm
Average power capability, max.	200 mW / 1550 nm
Return loss, min. / typ.	45 dB / 50 dB
Insertion loss, max. / typ.	3.0 dB / 2.0 dB
Wavelength	1.0 dB

Mechanical Characteristics

Life, min.	200 x 10 ⁶ revolutions
IP protection level	IP40 above flange / IP65 below flange (except FC/PC connector)
Weight, approx.	5 kg

1 to 4 Channel Fiber Optic Rotary Joint with Slip Ring

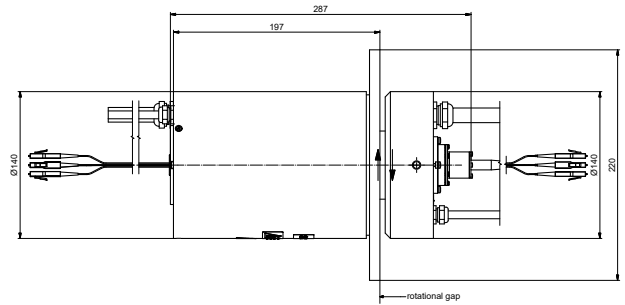

Fiber Optic Characteristics

Number of channels	1 to 4
Interface type	LC-APC / ceramic (acc. to IEC 61754-20)
Fibre type	Single mode E9/125 µm / 900 µm buffer
Wavelength	1310 nm / 1550 nm
Return loss, min. / typ.	50 dB / 55 dB
Insertion loss, max.	3.5 dB
Insertion loss variation over rotation, max.	1.5 dB
Cross talk, min.	50 dB
Isolation, min.	200 mW / 23 dBm

Slip Ring Characteristics

Total number of ways	13
----------------------	----

Mechanical Characteristics

Life, min.	10 x 10 ⁶ revolutions
IP protection level	IP50
Weight, approx.	11 kg



Company: _____ Contact name: _____

Address: _____ Phone / fax: _____

_____ Email: _____ @ _____

Your ref: _____ Date: _____

Project / delivery country: _____

Application: military use | ground airborne space | RF rotary joint FOJ rotary joint
 civil use | naval other _____ | media rotary joint encoder

Required quantity: Prototype _____ Serial _____ Delivery period: _____

Radio Frequency Characteristics – Total number of channels:

Channel designation	1	2	3	4	5	6
Interface type						
Frequency range						
Peak power rating						
Average power rating						
VSWR, max.						
VSWR variation over rotation, max.						
Insertion loss, max.						
Insertion loss variation over rotation, max.						
Isolation, min.						
Phase variation over rotation, max.						
Absolute phase difference						
Isolation, min.						
DC carrying capability, max.						

Mechanical Characteristics

Rotating speed, max.	rpm
Life, min. x revolutions
Torque (room temperature), max. N m @ start-up / N m @ rotation
IP protection level	IP..
Case material	
Case surface finish	
Weight, approx.	kg



Environmental Conditions

Operation	
Ambient temperature range °C to °C
Relative humidity, max.	%
Storage	
Ambient temperature range °C to °C
Relative humidity, max.	%

Documents Required

CoC according DIN 55350-18	<input type="checkbox"/>
Government source inspection	<input type="checkbox"/>
Environmental test	<input type="checkbox"/>
Other	<input type="checkbox"/>

Fiber Optic Channel Characteristics – Number of channels:

Interface type			
Fiber type	<input type="checkbox"/> single mode	<input type="checkbox"/> multi mode	<input type="checkbox"/>
Jacket			
Data transmission lines / mode			
Wavelength			
Return loss, min.			dB
Insertion loss, max.			dB
Insertion loss variation over rotation, max.			dB
Cross talk, min.			dB
Optical power, max.	mW /		dBm

Media Rotary Joint Characteristics

Channel LINE IN

Channel LINE OUT

Operative system pressure (kPa)	
Over pressure peak for 15 sec (kPa), max.	
Added pressure drop in both lines at flow (kPa), max.	@ liters/min
Flow rate	liters/min
Backflow leakage, max.	liters/min
Liquid/air composition*	
Nominal liquid temperature (°C)	
Liquid temperature range, min./max. (°C)	
Particle size in liquid (µm), max.	

*eg: 40% water + 60% ethylene glycol + inhibitors



Electrical Requirements – Total Number of Ways:

Designation of groups	A	B	C	D	E	F
Number of ways per group						
Application						
Normal current	A	A	A	A	A	A
Maximum current / period						
Voltage	V	V	V	V	V	V
Frequency	kHz	kHz	kHz	kHz	kHz	kHz
Isolation resistance / 500 V DC						
Dielectrical strength						
Resistance (end to end)						
Noise	Ω	Ω	Ω	Ω	Ω	Ω
Crosstalk						
Insertion loss	dB	dB	dB	dB	dB	dB
Impedance						
VSWR, max.						
Protection earth						
Switch-off time						

Mechanical Characteristics

Average rotational speed, max.	rpm
Rotating speed, max.	rpm
Turning torque static, max.	N m
Turning torque dynamic, max.	N m
Surface finish	

Dimensions / Limitations/ Conditions

Outer diameter, max.	mm
Free inner bore	<input type="checkbox"/> yes, mm <input type="checkbox"/> no
Total length	mm
Weight, max.	kg

Life Time | Maintenance

Operation time / duty cycle (Hour per time interval)	
Life, min. x revolutions
Maintenance x revolutions
Brush change x revolutions
Warranty conditions	

Required Quality Documents

CoC according DIN 55350-18	<input type="checkbox"/>
Government source inspection	<input type="checkbox"/>
Environmental test	<input type="checkbox"/>
Other	<input type="checkbox"/>
.....	

Environmental Conditions

Isolation (per EN60529)	
Vibration / Shock / Acceleration	



Type of Connection

Rotor Stator	Rotor: Connector	<input type="checkbox"/>	Stator: Connector	<input type="checkbox"/>
	Cable	<input type="checkbox"/>	Cable	<input type="checkbox"/>
	Solder terminal	<input type="checkbox"/>	Solder terminal	<input type="checkbox"/>
	Screw terminal	<input type="checkbox"/>	Screw terminal	<input type="checkbox"/>
Length of cable	m		m	
Mating connectors to be supplied	<input type="checkbox"/>			

Description of Application:

Technical Annex

WR 650 / R 14 / WG 6

Origin
Flange style
Standard

Standards are listed together with their issue status.

Exception: For lack of space the standard „IEC 60154-2: 1980 + A1: 1997“ has been depicted as „IEC 60154-2“

Flange designation

(Historic AN designation, if available)

Simplified 3D scetch indicating the basic dimensions of the flange front

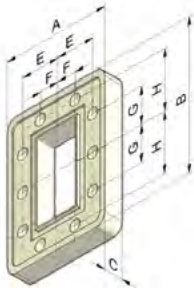

Dimensions

All dimensions are of nominal nature. They are not necessarily in the center of their tolerance band.

Dimensional tolerances are not listed.

Dimensions with decimal comma are in millimeters.

Dimensions with decimal point are in inches.

A complete document TD-00077 with a summary of all rectangular waveguide flanges can be downloaded under following link:

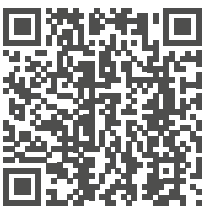

http://www.spinner-group.com/images/download/technical_documents/SPINNER_TD00077.pdf

International
Plain
IEC 60154-2
154 IEC-UDR 14

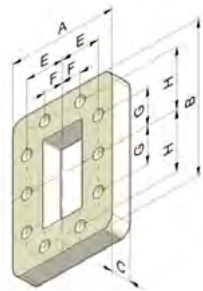

A	138,1
B	220,7
E	58,69
F	31,73
G	60,3
H	100
Hole I	Ø 8
Hole J	
C	12,7
Material	

International
Sealing groove
IEC 60154-2
154 IEC-PDR 14

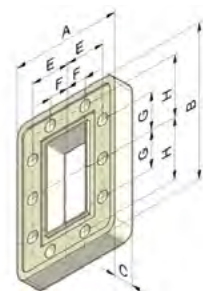

A	138,1
B	220,7
E	58,69
F	31,73
G	60,3
H	100
Hole I	Ø 8
Hole J	
C	12,7
Material	

USA
Plain
EIA RS-271-A
CPR 650 F

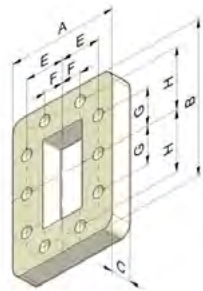

A	138,09 (5.437)
B	220,65 (8.687)
E	58,7 (2.311)
F	31,73 (1.249)
G	60,3 (2.374)
H	100 (3.937)
Hole I	Ø 8,33 (Ø 0.328)
Hole J	
C	
Material	Cu, Al, Mg alloys

USA
Sealing groove
EIA RS-271-A
CPR 650 G

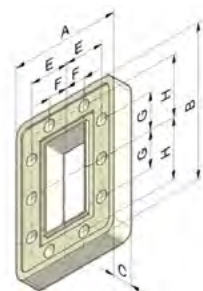

A	138,09 (5.437)
B	220,65 (8.687)
E	58,7 (2.311)
F	31,73 (1.249)
G	60,3 (2.374)
H	100 (3.937)
Hole I	Ø 8,33 (Ø 0.328)
Hole J	
C	
Material	Cu, Al, Mg alloys

Technical Annex

WR 284 / R 32 / WG 10

International
Plain
IEC 60154-2
154 IEC-UDR 32

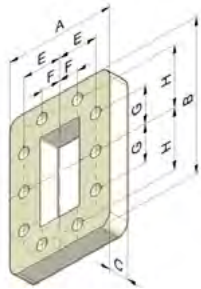

A	76,2
B	114,3
E	29,57
F	14,68
G	32,54
H	48,61
Hole I	Ø 6,35
Hole J	
C	10
Material	

USA
Plain
EIA RS-271-A
CPR 284 F

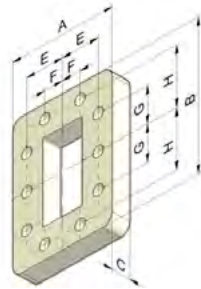

A	76,2 (3)
B	114,3 (4.5)
E	29,57 (0.164)
F	14,68 (0.578)
G	32,53 (1.281)
H	48,62 (1.914)
Hole I	Ø 6,55 (Ø 0.258)
Hole J	
C	
Material	Cu, Al, Mg alloys



International
Sealing groove
IEC 60154-2
154 IEC-PDR 32

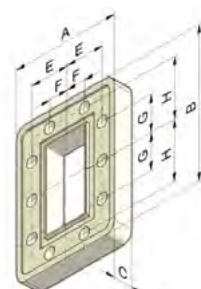

A	76,2
B	114,3
E	29,57
F	14,68
G	32,54
H	48,61
Hole I	Ø 6,35
Hole J	
C	10
Material	

USA
Plain
EIA RS-271-A
CPR 284 G

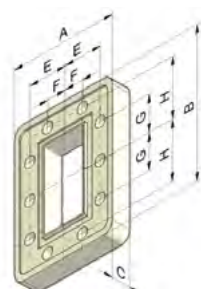

A	76,2 (3)
B	114,3 (4.5)
E	29,57 (0.164)
F	14,68 (0.578)
G	32,53 (1.281)
H	48,62 (1.914)
Hole I	Ø 6,55 (Ø 0.258)
Hole J	
C	
Material	Cu, Al, Mg alloys

USA
Choke/sealing groove
MIL-DTL-3922/61E
M3922/61-001 (UG-585A/U)

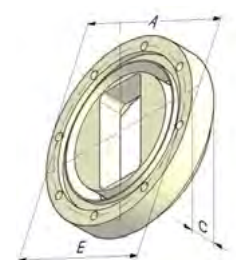

A	134,94 (5.312)
B	
E	120,65 (4.750)
F	
G	
H	
Hole I	0.250-20 UNC-2B
Hole J	
C	31,75 (1.250)
Material	Al alloy

Technical Annex

1. Purpose and Background

This document compiles the technical terms used by SPINNER in its product data sheets and other technical documents concerning rotary joints. Wherever possible we provided rigorous definitions of the terms. The task of a rotary joint is to enable low-loss transmission of electrical and optical signals between a static and a rotating part. Electrical power and media can also be transmitted if necessary.

Rotary joints may also be equipped with further subsystems like angular encoders and revolution counters. SPINNER's design capabilities include systems for data, power and media transmission as well as radio frequency (RF) signals.

2. General Terms

Rotary joint

A rotary transition featuring an unlimited angle of rotation. Commonly a rotary joint is abbreviated as RJ or R/J, in case of fiber optical rotary joint as FORJ.

Swivel joint

Any rotary transition featuring a limited angle of rotation.

Channel

Describes a physical transmission path having one port on the stator and one port on the rotor. Unlike in telecommunication engineering, this term does not describe a certain limited portion of the electro-magnetic spectrum when used in this context.

Module

A basic element of a rotary joint which often covers a single transmission channel. Multichannel designs are commonly comprised of several independent modules.

Hollow-shaft module

A module with a clear inner bore along its axis of rotation. Usually hollow-shaft modules are stackable to create multichannel rotary joints. In that case the inner transmission lines of all neighboring modules are fed through the center bore.

On-axis module (center module)

A module without a center bore. Commonly used as the final stacking element in multichannel units.

Stator

Static portion of a rotary joint. A stator is not necessarily characterized by the presence of a mounting flange.

Rotor

Rotating portion of a rotary joint. A rotor is not necessarily characterized by the absence of a mounting flange.

Rotational gap

Necessary mechanical gap which separates stator and rotor.

Rotational angle

Angle θ between rotor and stator.

Contacting rotary joint

A rotary joint utilizing galvanic sliding contacts. Typically, wide-band designs are based on contacting coupling structures. Furthermore, contacting designs allow for DC transmission and can handle low frequency signals at limited space. Operational life is limited however (usually to some 10^6 to 10^7 revolutions) because of contact wear.

Non-contacting rotary joint

A rotary joint based on non-contacting coupling mechanisms like capacitive, inductive, transmission line or transformer coupling.

Non-contacting rotary joints generally cover a limited bandwidth (typical relative bandwidth less than 40%; in most applications some 10 to 20%) because of frequency-dependent coupling mechanisms. Non-contacting rotary joints offer superior product life time over contacting designs since contact wear is eliminated. Typical life figures are only limited by the bearing or sealing system and might be as high as several hundred millions of revolutions.

The transmission line coupling mechanism is usually limited to channels operating in the GHz frequency range because lower frequencies would result in large coupling structures.

Slip ring

A particular variant of a contacting low frequency rotary joint, mostly equipped with a large-diameter center bore. Slip rings are based on ring and static brush systems and commonly used for power and signal transmission.

Slip ring assemblies for big multichannel rotary joints may feature some 100 ways and are often used to accommodate the (smaller) RF subsystems which are nested inside the slip ring's center bore.

Fiber optic rotary joint

A fiber optic rotary joint (FORJ) is the optical equivalent of an RF rotary joint or an electrical slip ring. It allows the transmission of an optical signal while rotating.

Single channel and multichannel FORJs are available with both single- and multimode fiber types.

Maximum or minimum values

Maximum or minimum values represent guaranteed limit values which are not exceeded at any time or under any condition specified in the data sheet.

Usually there is a safety margin between these guaranteed maximum limits and the values measured at room temperature.

Typical values

In many cases SPINNER specifies both maximum and typical values. Typical values are given whenever useful for a more realistic description of the performance. These values are typically observed on the majority of a produc-



Technical Annex

tion batch when measured at room temperature. SPINNER does not guarantee these "typical values" however.

RF port numbering

In order to define the scattering matrix of a rotary joint a non-ambiguous designation of the RF ports is required. If not otherwise defined SPINNER uses the following RF port numbering convention for its documents (e.g. data sheets, interface control drawings, qualification test procedures and records, acceptance test procedures and records):

Channel number	Port number on labeled* part	Port number on unlabeled* part
1	1	2
2	3	4
...
i	2i-1	2i

Following this convention the scattering matrix [S] of a n-channel rotary joint can be written as

$$[S] = \begin{bmatrix} S_{1,1} & S_{1,2} & \dots & S_{1,2n-1} & S_{1,2n} \\ S_{2,1} & S_{2,2} & \dots & S_{2,2n-1} & S_{2,2n} \\ \vdots & \vdots & \ddots & \vdots & \vdots \\ S_{2n-1,1} & S_{2n-1,2} & \dots & S_{2n-1,2n-1} & S_{2n-1,2n} \\ S_{2n,1} & S_{2n,2} & \dots & S_{2n,2n-1} & S_{2n,2n} \end{bmatrix} \xrightarrow{\text{ideal** case}} \begin{bmatrix} 0 & 1 & \dots & 0 & 0 \\ 1 & 0 & \dots & 0 & 0 \\ \vdots & \vdots & \ddots & \vdots & \vdots \\ 0 & 0 & \dots & 0 & 1 \\ 0 & 0 & \dots & 1 & 0 \end{bmatrix}$$

* Rotary joints consist of a stator and a rotor which are rotating relatively to each other. One of these two parts is marked with the product number BN XXXXXX, this is called the "labeled" part. The other part is called "unlabeled".

** "Ideal" in this context means: impedance-matched, lossless, fully decoupled, electrical length negligible.

3. Radio Frequency Characteristics

Interface type

Generally, SPINNER RF rotary joints come with either waveguide or coaxial ports.

The appropriate choice depends on application, frequency range and power rating requirements. Most waveguide rotary joints feature standardized waveguide interfaces according to IEC-154, MIL-DTL-3922 or EIA-RS 271, which may be either of the plain or choke type. Grooves on sealed flanges in combination with gaskets allow for pressurization and provide protection against ingress of dirt and moisture. Internal corners of waveguide interfaces are sometimes rounded for manufacturing reasons. These rounded corners have been designed carefully and thus are fully electrically compensated when mated to "real" rectangular standard waveguides. Consequently, RF performance will not be compromised at all by the rounding. Coaxial designs are usually equipped with precision coaxial connectors according to IEEE Std. 287-2007.

Interface orientation

Describes the basic style of a rotary joint depending on the orientation of both interfaces (rotor and stator). Several waveguide designs may actually only be realized as "U" styles and must be adapted to the desired style using external waveguides.

"I"-style: Both interfaces in line with the rotational axis.

"U"-style: Both interfaces perpendicular to the rotational axis.

"L"-style: One interface is perpendicular to the rotational axis, the other interface is in line with the rotating axis.

Frequency range

Portion of the electromagnetic spectrum which a component has been designed for and within which the respective specification is valid.

SPINNER offers designs for the entire frequency range between DC and the millimeter wave range. In the following the frequency range will be referred to as FR.

Peak power capability

Maximum permissible short term power which a component can handle safely without internal arcing or breakdown.

In contrast to "instantaneous values", this term refers to short-term RMS values within the pulse duration. Usual pulse durations are in the μs range. It should be pointed out that the actual peak power capability depends considerably on parameters such as absolute air pressure inside the component, load VSWR, temperature, pulse duration and pulse repetition frequency. Specifying the required operating pressure for a given peak power is of paramount importance. While low ambient air pressure will degrade the peak power capability, it can be massively enhanced by a pressurization of all electrically stressed components with dry compressed air or particular insulation gases like SF6. If space use is intended, a different vacuum discharge mechanism called "multipactor discharge" becomes crucial. SPINNER datasheets provide all necessary information about these limiting conditions.

Depending on the connector size, coaxial rotary joints usually feature peak power figures in the 1 to 10 kW range while typical values for unpressurized waveguide rotary joints might be as high as 10 kW to 1 MW (also depending on waveguide size).

Peak power capability is limited to the air pressure at sea level unless otherwise noted.

Average power capability

Maximum permissible long term ("continuous wave" or CW) power which a component can handle safely without internal overheating.

During operation Ohmic and dielectric losses generate heat inside the rotary joint. Hence, the maximum permissible average power is frequency-dependent. The relation between heat generation and heat dissipation (by metallic



Technical Annex

feeder waveguides, casing, mounting flanges and air convection) determines the actual CW power that may be applied over a long period of time while still ensuring safe internal operating temperatures for all critical parts.

Average power handling may be increased by additional forced cooling (air or water) and use of advanced materials or designs. Excessive ambient temperatures will degrade the average power capability respectively.

VSWR

"Voltage Standing Wave Ratio", an expression for the degree of wave reflection from a component due to impedance mismatch.

Ideally, in the perfectly matched case there is no reflected wave and VSWR is equal to 1. It is infinite in the case of total reflection.

High VSWR values are not desirable because they indicate a high percentage of reflected power and contribute to insertion loss. A high VSWR will also cause locally raised voltages due to standing waves and therefore compromise power handling.

Often a tradeoff between VSWR and bandwidth has to be found. Usual VSWR values would range from 1.10 to 1.70. Specialized big center bore designs which must cover a very wide bandwidth cannot reach these values however.

"VSWR, max.", as given in SPINNER data sheets, represents worst-case values that besides frequency response also include thermal and rotational effects.

$$VSWR_{max} = \max_{f \in FR} \left\{ \max_{0^\circ \leq \theta < 360^\circ} \{VSWR(f, \theta)\} \right\}$$

Example:

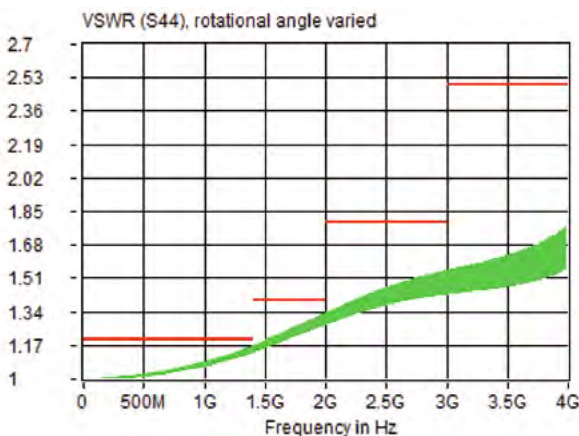

Return loss

Alternative representation of VSWR, describes the logarithmic ratio (in dB) between incident power P_{in} and reflected power P_r at a component's port:

$$a_r = 10 \text{ dB} \cdot \log P_{in} / P_r$$

The return loss is infinite in the perfectly matched case and zero at total reflection. A high return loss figure is desirable and indicates a well matched component. Return loss values usually range from 10 dB to 40 dB.

VSWR variation over rotation

Sometimes also named "VSWR WOW", this parameter describes how much VSWR changes over a full rotation at the "worst" frequency within the specified frequency range.

For this parameter several different definitions are in use. The most popular ones are the difference definition $\Delta VSWR$ and the ratio definition $VSWR_{ratio}$.

SPINNER generally adheres to the difference definition which expresses "VSWR variation over rotation, max." $\Delta VSWR_{max}$ as the difference between the maximum and minimum VSWR values measured at the frequency point f_{VSWRv} which features the highest VSWR variation over the rotational angle θ :

$$\Delta VSWR(f) = \max_{0^\circ \leq \theta < 360^\circ} \{VSWR(f, \theta)\} - \min_{0^\circ \leq \theta < 360^\circ} \{VSWR(f, \theta)\}$$

$$\Delta VSWR_{max} = \Delta VSWR(f_{VSWRv}) = \max_{f \in FR} \{\Delta VSWR(f)\}$$

For practical measurements the definition above is often approximated by the maximum distance between the two VSWR frequency response curves taken at the "worst" and the "best" rotational angle. Common values are between 0.02 and 0.2.

The other common definition, the ratio definition, is given by

$$VSWR_{ratio}(f) = \frac{\max_{0^\circ \leq \theta < 360^\circ} \{VSWR(f, \theta)\}}{\min_{0^\circ \leq \theta < 360^\circ} \{VSWR(f, \theta)\}}$$

$$VSWR_{ratio,max} = VSWR_{ratio}(f_{VSWRv}) = \max_{f \in FR} \{VSWR_{ratio}(f)\}$$

The ratio definition leads to values greater than one. SPINNER uses this definition only when it is explicitly required by a customer.

Example:

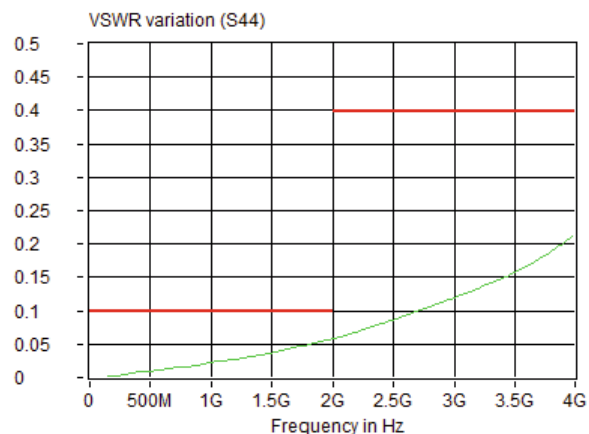



Technical Annex

Insertion loss

Attenuation of a signal being passed through a device within the signal path. Insertion loss a_i is usually expressed as the logarithmic ratio (in dB) between incident power P_{in} and output power P_{out} :

$$a_i = 10 \text{ dB} \cdot \lg \frac{P_{in}}{P_{out}}$$

Internal transmission line structures, feeder waveguides or cables cause Ohmic, dielectric and reflection losses. The dissipated energy results in heat generation and limits the maximum permissible long-term power rating.

Generally speaking, long designs suffer from higher insertion loss than shorter ones and waveguide designs are usually superior to coaxial designs. Whenever there is a choice, the system waveguide size should be chosen as big as possible because of increased waveguide losses in the lower portion of their operating band.

Insertion loss is somewhat temperature-dependent. SPINNER would like to point out that any insertion loss figures stated in SPINNER data sheets hold true for the entire specified range of operating temperatures and the nominal operating power.

Most waveguide rotary joints feature insertion loss values in the 0.1 dB to 0.5 dB range, and so do usual coaxial designs without cables. Large multichannel rotary joints contain additional internal cables which may cause significant additional losses.

"Insertion loss, max.", as given in SPINNER data sheets, represents worst-case values that besides frequency response also include thermal and rotational effects.

$$a_{i,max} = \max_{f \in FR} \left\{ \max_{0^\circ \leq \theta < 360^\circ} \{a_i(f, \theta)\} \right\}$$

Example:

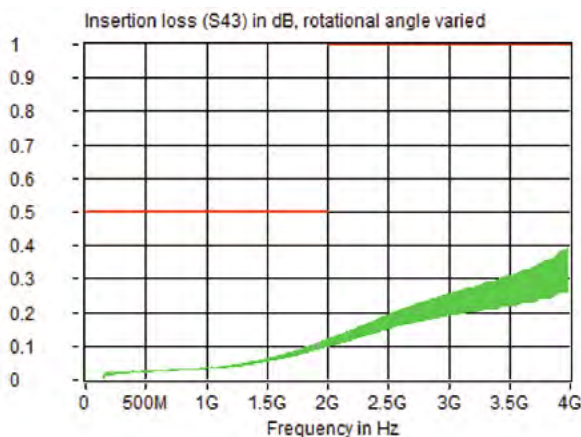

Insertion loss variation over rotation

Sometimes also named "insertion loss WOW", this parameter describes how much insertion loss changes over a full rotation at the "worst" frequency within the specified frequency range. For most technical applications this parameter is of higher relevance than VSWR variation over rotation.

"Insertion loss variation over rotation, max." $\Delta a_{i,max}$ is defined as the difference between the maximum and minimum insertion loss values measured at the frequency f_{ILV} which features the highest insertion loss variation over the rotational angle θ :

$$\Delta a_i(f) = \max_{0^\circ \leq \theta < 360^\circ} \{a_i(f, \theta)\} - \min_{0^\circ \leq \theta < 360^\circ} \{a_i(f, \theta)\}$$

$$\Delta a_{i,max} = \Delta a_i(f_{ILV}) = \max_{f \in FR} \{\Delta a_i(f)\}$$

For practical measurements the definition above is often approximated by the maximum distance between the two insertion loss frequency response curves taken at the "worst" and the "best" rotational angle.

Insertion loss variation is mostly a footprint of VSWR variation which in turn causes varying reflection losses. Any "insertion loss variation over rotation, max." figures given in SPINNER data sheets are worst-case values (usually between 0.05 dB and 0.2 dB) and do already include a safety margin to consider measurement instabilities and drift.

Example:

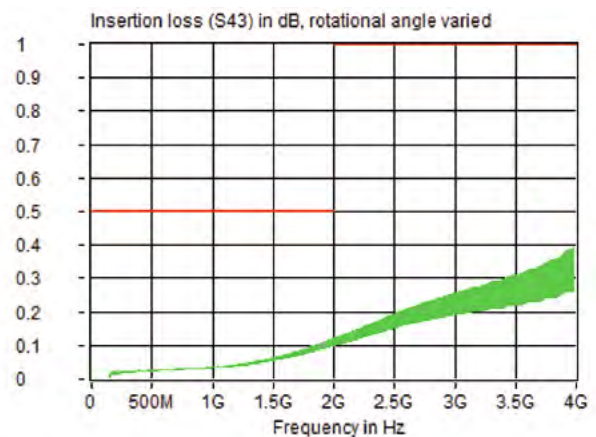

Phase variation over rotation

Phase variation over rotation or "phase WOW" describes how much the insertion phase of a rotary joint changes over a full rotation at the "worst" frequency within the specified frequency range.

This parameter indicates a variation of the effective electric length. Along with insertion loss variation over rotation it is of higher relevance for most technical applications than VSWR variation.



Technical Annex

"Phase variation over rotation, max." $\Delta\varphi_{i,max}$ is defined as the difference between the maximum and minimum insertion phase values measured at the frequency point f_{PV} which features the highest phase variation over the rotational angle θ :

$$\Delta\varphi_i(f) = \max_{0^\circ \leq \theta < 360^\circ} \{\varphi_i(f, \theta)\} - \min_{0^\circ \leq \theta < 360^\circ} \{\varphi_i(f, \theta)\}$$

$$\Delta\varphi_{i,max} = \Delta\varphi_i(f_{PV}) = \max_{f \in FR} \{\Delta\varphi_i(f)\}$$

For practical measurements the definition above is often approximated by the maximum distance between the two insertion phase frequency response curves taken at the "worst" and the "best" rotational angle.

Any "phase variation over rotation, max." figures given in SPINNER data sheets are worst-case values (usually of the order of 0.5 to 5 degrees) and do already include a safety margin to consider measurement instabilities and drift.

Example:

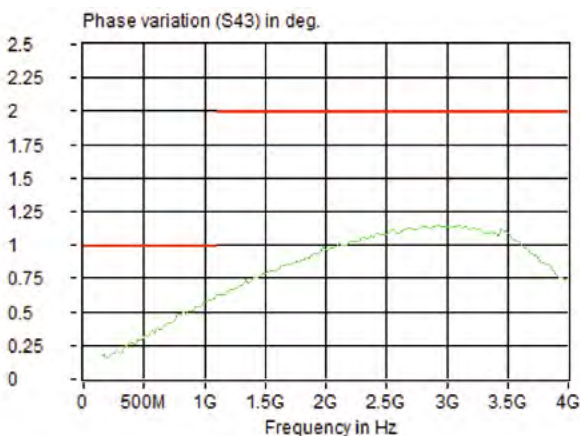

Absolute insertion loss difference

This parameter is only defined for two channels operating in the same frequency range. It describes the difference between their insertion loss figures at a certain frequency and rotational angle θ .

"Absolute insertion loss difference, max." ILD_{max} , as given in SPINNER datasheets, describes the worst-case insertion loss difference value over the rotational angle θ within the operating frequency band:

$$ILD(f, \theta) = a_{i,CH1}(f, \theta) - a_{i,CH2}(f, \theta)$$

$$ILD_{max} = \max_{f \in FR} \left\{ \max_{0^\circ \leq \theta < 360^\circ} |ILD(f, \theta)| \right\}$$

If required careful tuning of the internal cable lengths enables insertion loss matching of channels within 0.1 to 0.2 dB (for coaxial multichannel rotary joints).

Phase difference absolute

Like insertion loss difference, this parameter is only defined for two channels operating in the same frequency range. It describes the difference between their insertion phases at a certain frequency and rotational angle θ .

"Absolute phase difference, max." PD_{max} , as given in SPINNER datasheets, describes the worst-case phase difference value over the rotational angle θ within the operating frequency band:

$$PD(f, \theta) = \varphi_{i,CH1}(f, \theta) - \varphi_{i,CH2}(f, \theta)$$

$$PD_{max} = \max_{f \in FR} \left\{ \max_{0^\circ \leq \theta < 360^\circ} |PD(f, \theta)| \right\}$$

If required careful tuning of the internal cable lengths enables phase matching of channels within a few degrees (for coaxial multichannel designs, depending on wavelength).

Example:

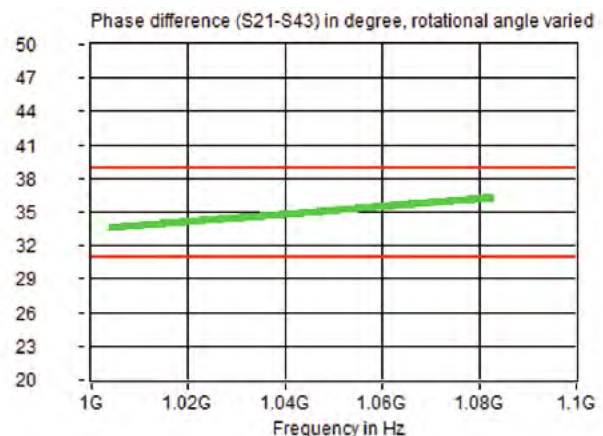

Insertion loss tracking over rotation

Insertion loss tracking is only defined for two channels operating in the same frequency range. It describes their insertion loss synchronism over rotation.

Two modules, each suffering from high insertion loss variation over rotation, can still result in a dual channel rotary joint with good insertion loss tracking since the two individual variations may be similar and therefore cancel out if combined properly.

This parameter could also be expressed as "variation of insertion loss difference over rotation".

"Insertion loss tracking, max." ILT_{max} is defined as the difference between the maximum and minimum insertion loss difference values over the rotational angle θ within the operating frequency band:

$$ILT(f) = \max_{0^\circ \leq \theta < 360^\circ} \{ILD(f, \theta)\} - \min_{0^\circ \leq \theta < 360^\circ} \{ILD(f, \theta)\}$$

$$ILT_{max} = ILT(f_{ILT}) = \max_{f \in FR} \{ILT(f)\}$$



Technical Annex

Phase tracking over rotation

Phase tracking is only defined for two channels operating in the same frequency range. It describes their phase synchronism over rotation.

Two modules, each suffering from high phase variation over rotation, can still result in a dual channel rotary joint with good phase tracking since the two individual variations may be similar and therefore cancel out if combined properly.

This parameter could also be expressed as "variation of phase difference over rotation".

"Phase tracking, max." PTmax is defined as the difference between the maximum and minimum phase difference values over the rotational angle θ within the operating frequency band:

$$PT(f) = \max_{0^\circ \leq \theta < 360^\circ} \{PD(f, \theta)\} - \min_{0^\circ \leq \theta < 360^\circ} \{PD(f, \theta)\}$$

$$PT_{max} = PT(f_{PT}) = \max_{f \in FR} \{PT(f)\}$$

Some applications, for example secondary surveillance radar (SSR), require well matched rotary joint channels (both insertion loss and phase) along with tracking requirements.

Isolation

Describes the crosstalk between two channels.

The amount of RF energy leaking from one channel to a second one is usually expressed as insertion loss (in dB) between one port of the first channel and another port of the second channel while all remaining ports are properly terminated. Depending on the choice of ports two different isolation types must be considered: Forward and reverse isolation. All isolation values given by SPINNER represent worst-case values including both forward and reverse isolation.

Common values are some 50 to 70 dB while particular designs, especially waveguide rotary joints designed for exceptionally high power, allow for isolation values around 100 dB.

Example:

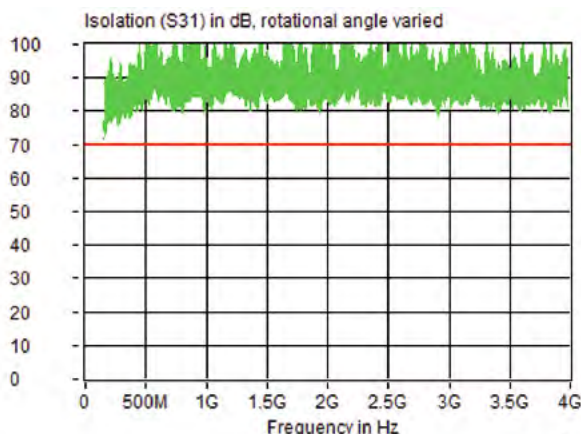

RF-shielding

RF shielding describes the amount of RF energy leaking from a channel out of the rotary joint into the surrounding space. It is often confirmed by analysis and expressed in dB.

DC carrying capability

Naturally, this parameter is only specified for contacting rotary joints. It describes the maximum DC current that can be safely transmitted over a rotary joint. This may be of relevance for applications where biased electronic assemblies are located close to the antenna. If high direct (or low frequency) current transfer is demanded, the RF power capability is usually compromised.

Because of the delicate nature of several contact parts inside most RF rotary joints the DC carrying capability is commonly limited to currents of a few amperes and to low voltages.

If higher DC or low frequency AC power transmission capabilities are desired, SPINNER encourages the use of slip ring assemblies particularly designed for this purpose.

Additive phase noise

Additive phase noise, also referred to as residual phase noise, is the self phase noise of a component that adds to an existing signal as it passes through it. In rotary joints additive phase noise is caused by small variations in insertion loss and electrical phase during operation.

4. Fiber Optic Characteristics

Interface type

Generally SPINNER FORJs come with fiber pigtailed which are equipped with either standard telecom fiber optic connectors or customized connectors.

Fiber type

SPINNER FORJs are available with the following fiber types:

- 50/125 GI (gradient index, multimode)
- 62.5/125 GI (gradient index, multimode)
- 9/125 SM (step index, singlemode)

Wavelength

Portion of the electromagnetic spectrum which a component has been designed for and within which the respective specification is valid. SPINNER offers designs for the standard optical windows at 850 nm, 1310 nm or 1550 nm. FORJs for broadband applications are also available.

In the following the wavelength range will be referred to as WR.

Technical Annex

Average power capability

Maximum permissible long term ("continuous wave" or CW) power which a component can handle safely without internal overheating.

Common values are 200 mW (23 dBm) for FORJs.

Return loss

Describes the logarithmic ratio (in dB) between incident power P_{in} and reflected power P_r at a component's port:

$$a_r = 10 \text{ dB} \cdot \lg \frac{P_{in}}{P}$$

The return loss of a FORJ is determined in accordance to IEC 61300-3-6:2008 method 1.

Any "return loss, min." figures given in SPINNER data sheets are worst-case values (usually between 40 dB and 55 dB for FORJs).

Insertion loss

Attenuation of a signal being passed through a device within the signal path.

Insertion loss a_i is usually expressed as the logarithmic ratio (in dB) between incident power P_{in} and output power P_{out} :

$$a_i = 10 \text{ dB} \cdot \lg \frac{P_{in}}{P_{out}}$$

The insertion loss of a FORJ is determined in accordance to IEC 61300-3-4:2012 insertion method (C).

Insertion loss is somewhat temperature-dependent. SPINNER would like to point out that any insertion loss figures stated in SPINNER data sheets hold true for the entire specified range of operating temperatures and the nominal operating power.

Any "insertion loss, max." figures given in SPINNER data sheets are worst-case values (usually between 1 dB and 4 dB for FORJs).

Insertion loss variation over rotation

Sometimes also named "insertion loss WOW", this parameter describes how much insertion loss changes over a full rotation at defined wavelengths.

"Insertion loss variation over rotation, max." $\Delta a_{i,max}$ is defined as difference between the maximum and minimum insertion loss values measured at the wavelength which features the highest insertion loss variation over the rotational angle θ :

$$\Delta a_i(\lambda) = \max_{0^\circ \leq \theta < 360^\circ} \{a_i(\lambda, \theta)\} - \min_{0^\circ \leq \theta < 360^\circ} \{a_i(\lambda, \theta)\}$$

$$\Delta a_{i,max} = \max_{\lambda \in WR} \{\Delta a_i(\lambda)\}$$

Any "insertion loss variation over rotation, max." values given in SPINNER data sheets are worst-case values (usually between 0.5 dB and 1.5 dB for FORJs).

Isolation

Describes the crosstalk between two channels. Any isolation values given by SPINNER represent worst-case values including both forward and reverse isolation. Common values are some 50 dB for FORJs.

5. Mechanical Characteristics

Differential operating pressure

Differential pressure between pressurized area within the RF part and environment indicated in MPa (10^6 Pa) and in bar.

"Differential operating pressure, max.", as given in SPINNER datasheets, is valid for the complete operating ambient temperature range. The term "Differential operating pressure, nominal" describes the recommended operating condition.

Absolute operating pressure

Absolute pressure within the RF part of the rotary joint indicated in MPa and in bar.

"Absolute operating pressure, min.", as given in SPINNER datasheets, describes the minimum pressure to be maintained in all operating conditions to ensure the peak power capability of the rotary joint. Depending on the type of insulating gas different minimum pressures need to be maintained.

Operating pressure, differential

Differential pressure between pressurized area within the RF part and environment indicated in MPa (10^6 Pa) and in bar. "Differential operating pressure, max.", as given in SPINNER datasheets, is valid for the complete operating ambient temperature range. The term "Differential operating pressure, nominal" describes the recommended operating condition.

Leakage rate

Leakage rate for pressurized wave guides valid for the indicated operating ambient temperature range. Usually indicated as maximum value valid at the indicated nominal differential pressure.

Rotating speed

Rotational speed in rpm, Usually indicated as nominal and maximum speed.

Life

Life time usually indicated in number of revolutions. Life time is limited by the type (contacting) of transmission as well as by bearings and dynamic seals. The life time can be extended by dedicated maintenance tasks, available for some products.

Technical Annex

Torque

The torque of a rotary joint gives the mechanical resistance during start up or turning at nominal speed. Usually these two values are indicated in Nm, for room temperature and for the minimum specified operating ambient temperature. If no temperature is indicated, the torque is defined at room temperature. Torque values for all other temperatures can be given upon request.

Interface loads

The interface loads coming from the installation of the rotary joint will have an effect on the bearing design. SPINNER rotary joints usually are not designed to withstand external forces; which means that no or no significant loads are allowed. In some case also some loads are indicated which can be introduced into the system. In that cases the loads are expressed as forces in axial and radial direction as well as the bending moment on the interface axis.

Case material

The case material is the material of the housings and main flanges. For the internal design also other materials are used. Typical materials are aluminum alloy, copper alloy or stainless steel.

Case surface finish

The case surface finish is the surface treatment of the housings and main flanges. For the internal design also other surface treatments are used. Some joints do not have any surface treatments, other typical treatments are chromate conversion coat per MIL-DTL-5541 (e.g. Surtech 650), silver plated or painted (e.g. two-component paints, PU-based, color according to RAL or other specifications).

Weight

Weight of rotary joint assembly without mounting screws and protective packing.

Marking

Marking or labeling of the rotary joint. Typical solutions are adhesive label, riveted label, laser engraving, engraving or stamping.

6. Environmental Conditions

Application

The application indicates the general environment of the installed rotary joint. The application is typically defined as airborne plane, airborne helicopter, ground fixed, ground mobile, shipboard, submarine, or satellite according to MIL-HDBK-217.

Ambient temperature range

Temperature range of the environment in °C. Typically indicated for operating and for storage condition. If not otherwise indicated SPINNER assumes that no heat from external sources is introduced into the rotary joint.

Relative humidity

The ratio of the actual vapor pressure of the air to the saturation vapor pressure in %. Typically indicated as a maximum value, valid for the complete temperature range (ambient or storage) It must be ensured, that condensation does not appear.

IP protection level

All IP protection levels are given according to EN 60529. Typical IP classes are:

IP 40: Protection against wires and screws;
no protection against liquids

IP 54: Protection against dust & splashing water

IP 65: Dust tight & protected against water jets

The given IP classes are valid for all installation directions unless otherwise noted. To achieve the given IP class the rotary joint must be installed and connected correctly as well as mounted with the appropriate gaskets.

Shock

Information for the compliance demonstration according to MIL-STD-810G, Method 516 "Shock".

Vibration

Information for the compliance demonstration according to MIL-STD-810G, Method 514 "Vibration".

Salt fog

Information for the compliance demonstration according to MIL-STD-810G, Method 509 "Salt Fog".

Icing/Freezing Rain

Information for the compliance demonstration according to MIL-STD-810G, Method 521 "Icing/Freezing Rain".

Fungus

Information for the compliance demonstration according to MIL-STD-810G, Method 508 "Fungus".

Rain

Information for the compliance demonstration according to MIL-STD-810G, Method 506 "Rain".

Sand and Dust

Information for the compliance demonstration according to MIL-STD-810G, Method 510 "Dust".

Room temperature

Room temperature is defined to $(20 \pm 5)^\circ\text{C}$



You can find the current version of this rotary joints glossary at:
www.spinner-group.com/en/download
(TD-00021)

Technical Annex

Unit Conversion

Purpose

For the physical quantities used in its product data sheets and other technical documents SPINNER generally utilizes the International System of Units (SI units). The aim of the present document is to provide the necessary relations for converting SI units into non-SI units and vice versa.

Length

	Meter (m)	Millimeter (mm)	Inch (in)	Mil (mil)	Foot (ft)	Yard (yd)	Mile (mi*)
1 m	1.0	1000.0	39.37	39370.0	3.2808	1.0936	621.371×10^{-6}
1 mm	0.001	1.0	0.03937	39.37	3.281×10^{-3}	1.0936×10^{-3}	621.371×10^{-9}
1 in	25.4×10^{-3}	25.4	1.0	1000.0	1/12.0	1/36	15.783×10^{-6}
1 mil	25.4×10^{-6}	25.4×10^{-3}	0.001	1.0	1/12000.0	1/36000	15.783×10^{-9}
1 ft	0.3048	304.8	12.0	12000.0	1.0	1/3	189.394×10^{-6}
1 yd	0.9144	914.4	36.0	36000.0	3.0	1.0	568.182×10^{-6}
1 mi	1609.344	1609344.0	63360.0	63.36×10^{-6}	5280.0	1760.0	1.0

* 1 nautical mile = 1852 meter was adopted by the First International Extraordinary Hydrographic Conference (Monaco, 1929) under the name "International nautical mile".

* 1 mile (mi) \neq 1 nautical mile.

Volume (fluid)

	Cubic meter (m ³)	Liter* (l)	Gallon, U.S. (gal)	Cubic inch (in ³)	Pint, U.S. liquid (pt)
1 m ³	1.0	1000	264.2	61024	2113
1 l	10^{-3}	1	0.264	61.02	2.113
1 gal	3.785×10^{-3}	3.785	1	231	8
1 in ³	16.39×10^{-6}	16.39×10^{-3}	4.329×10^{-3}	1	34.63×10^{-3}
1 liq pt	473.2×10^{-6}	0.4732	1/8	28.875	1

* In 1964 the General Conference on Weights and Measures reestablished the name "liter" as a special name for the cubic decimeter. The recommended symbol for the liter in the United States is L.

Mass

	Kilogram (kg)	Gram (g)	Ounce (oz)	Pound (lb)
1 kg	1.0	1000.0	35.27	2.205
1 g	0.001	1.0	35.27×10^{-3}	2.205×10^{-3}
1 oz	28.35×10^{-3}	28.35	1.0	1/16
1 lb	453.6×10^{-3}	453.6	16.0	1.0



Force

	Newton (N)	Kilogram-force Kilopond (kp)	Pound-force (lbf)
1 N	1.0	0.10197	0.22482
1 kp	9.80665	1.0	2.2046
1 lbf	4.448	0.45359	1.0

Pressure

	Pascal (Pa)	Bar (bar)	Pound-force per square inch (psi)
1 Pa	1.0	10×10^{-6}	0.145×10^{-3}
1 bar	0.1×10^6	1.0	14.5
1 psi	6.895×10^3	68.95×10^{-3}	1.0

Notes: absolute pressure: psia = psi-absolute
 relative pressure: psig = psi-gauge

Torque

	Newton meter (N m)	Pound-force foot (lbf-ft)	Ounce-force inch (ozf-in)	Pound-force inch (lbf-in)
1 N m	1.0	0.738	141.6	8.851
1 lbf-ft	1.356	1.0	192.0	12.0
1 ozf-in	$7.062 \cdot 10^{-3}$	$5.208 \cdot 10^{-3}$	1.0	$62.5 \cdot 10^{-3}$
1 lbf-in	0.113	$83.333 \cdot 10^{-3}$	16.0	1.0

Temperature

To From	Degree Celsius (°C)	Kelvin (K)	Degree Fahrenheit (°F)
$\frac{T}{^\circ\text{C}}$	$= \frac{T}{^\circ\text{C}}$	$= \frac{T}{\text{K}} - 273.15$	$= (\frac{T}{^\circ\text{F}} - 32) \cdot \frac{5}{9}$
$\frac{T}{\text{K}}$	$= \frac{T}{^\circ\text{C}} + 273.15$	$= \frac{T}{\text{K}}$	$= (\frac{T}{^\circ\text{F}} + 459.67) \cdot \frac{5}{9}$
$\frac{T}{^\circ\text{F}}$	$= \frac{T}{^\circ\text{C}} \cdot 1.8 + 32$	$= \frac{T}{\text{K}} \cdot 1.8 - 459.67$	$= \frac{T}{^\circ\text{F}}$

Acceleration

Angular acceleration α	Tangential acceleration a_T
$\alpha = \frac{a_T}{r}$	$a_T = r \cdot \alpha$

Angular acceleration α in $\text{rad}\cdot\text{s}^{-2}$
 Tangential acceleration a_T in $\text{m}\cdot\text{s}^{-2}$
 Radius r in m

Leak rate and mass flow rate

	Millibar liter per second (T_n) *	Cubic centimeter per second (T_n, p_n)	Pascal liter per second (T_n)	Torr liter per second (T_n)	Kilogram per hour x air (20 °C)	Mole per second
1 $\frac{\text{mbar} \cdot \text{l}}{\text{s}}$	$1 \frac{\text{mbar} \cdot \text{l}}{\text{s}} (T_n)$	$0.9869 \frac{\text{cm}^3}{\text{s}} (T_n, p_n)$	$100 \frac{\text{Pa} \cdot \text{l}}{\text{s}} (T_n)$	$0.75 \frac{\text{Torr} \cdot \text{l}}{\text{s}} (T_n)$	$4.3 \cdot 10^{-3} \frac{\text{kg}}{\text{h}} \text{ air}(20^\circ\text{C})$	$4.41 \cdot 10^{-5} \frac{\text{mol}}{\text{s}}$
1 $\frac{\text{cm}^3}{\text{s}} (T_n, p_n)$	$1.01 \frac{\text{mbar} \cdot \text{l}}{\text{s}} (T_n)$	$1 \frac{\text{cm}^3}{\text{s}} (T_n, p_n)$	$101 \frac{\text{Pa} \cdot \text{l}}{\text{s}} (T_n)$	$0.76 \frac{\text{Torr} \cdot \text{l}}{\text{s}} (T_n)$	$4.3 \cdot 10^{-3} \frac{\text{kg}}{\text{h}} \text{ air}(20^\circ\text{C})$	$4.45 \cdot 10^{-5} \frac{\text{mol}}{\text{s}}$
1 $\frac{\text{Pa} \cdot \text{l}}{\text{s}} (T_n)$	$1 \cdot 10^{-2} \frac{\text{mbar} \cdot \text{l}}{\text{s}} (T_n)$	$\sim 1 \cdot 10^{-2} \frac{\text{cm}^3}{\text{s}} (T_n, p_n)$	$1 \frac{\text{Pa} \cdot \text{l}}{\text{s}} (T_n)$	$7.5 \cdot 10^{-3} \frac{\text{Torr} \cdot \text{l}}{\text{s}} (T_n)$	$4.3 \cdot 10^{-3} \frac{\text{kg}}{\text{h}} \text{ air}(20^\circ\text{C})$	$4.41 \cdot 10^{-7} \frac{\text{mol}}{\text{s}}$
1 $\frac{\text{Torr} \cdot \text{l}}{\text{s}} (T_n)$	$1.33 \frac{\text{mbar} \cdot \text{l}}{\text{s}} (T_n)$	$1.32 \frac{\text{cm}^3}{\text{s}} (T_n, p_n)$	$133 \frac{\text{Pa} \cdot \text{l}}{\text{s}} (T_n)$	$1 \frac{\text{Torr} \cdot \text{l}}{\text{s}} (T_n)$	$5.7 \cdot 10^{-3} \frac{\text{kg}}{\text{h}} \text{ air}(20^\circ\text{C})$	$5.87 \cdot 10^{-5} \frac{\text{mol}}{\text{s}}$
1 $\frac{\text{kg}}{\text{h}} \text{ air}(20^\circ\text{C})$	$230 \frac{\text{mbar} \cdot \text{l}}{\text{s}} (T_n)$	$230 \frac{\text{cm}^3}{\text{s}} (T_n, p_n)$	$2.3 \cdot 10^4 \frac{\text{Pa} \cdot \text{l}}{\text{s}} (T_n)$	$175 \frac{\text{Torr} \cdot \text{l}}{\text{s}} (T_n)$	$1 \frac{\text{kg}}{\text{h}} \text{ air}(20^\circ\text{C})$	$1.01 \cdot 10^{-2} \frac{\text{mol}}{\text{s}}$
1 $\frac{\text{mol}}{\text{s}}$	$2.27 \cdot 10^4 \frac{\text{mbar} \cdot \text{l}}{\text{s}} (T_n)$	$2.25 \cdot 10^4 \frac{\text{cm}^3}{\text{s}} (T_n, p_n)$	$2.26 \cdot 10^6 \frac{\text{Pa} \cdot \text{l}}{\text{s}} (T_n)$	$1.7 \cdot 10^4 \frac{\text{Torr} \cdot \text{l}}{\text{s}} (T_n)$	$99 \frac{\text{kg}}{\text{h}} \text{ air}(20^\circ\text{C})$	$1 \frac{\text{mol}}{\text{s}}$

Notes: Standard reference conditions: $T_n = 0^\circ\text{C}$, $p_n = 1013.25 \text{ mbar}$

$$\frac{p \cdot V}{T} = \text{const}$$



Technical Annex

Barometric formula (Atmospheric Pressure versus Altitude)

Atmospheric pressure $\frac{ph}{Pa}$	$p_h = 1013.25hPa \left(1 - \frac{0.0065 \cdot h}{288.15m}\right)^{5.255}$
Altitude $\frac{h}{m}$	$h = \frac{\left(1 - \left(\frac{p_h}{1013.25hPa}\right)^{\frac{1}{5.255}}\right) \cdot 288.15}{0.0065}m$

Conditions:

Standard temperature lapse rate:	0.0065 K·m ⁻¹
Standard temperature (sea level):	15 °C = 288.15 K
Static pressure (sea level):	1013.25 hPa
Gravitational acceleration:	9.807 m·s ⁻²
Molar mass of earth's air:	0.02896 kg/mol
Universal gas constant for air:	8.314 J·(K·mol) ⁻¹

High (m)	Pressure (ft)	Pressure (hPa)	Pressure (psia)
0	0	1013.3	14.69
457	1500	959.5	13.91
1000	3281	898.8	13.03
2000	6562	794.98	11.53
2438	8000	752.7	10.91
3000	9842	701.1	10.17
4000	13123	616.5	8.94
5000	16404	540.3	7.83
6000	19685	471.9	6.84
8000	26246	356.1	5.16

High (m)	Pressure (ft)	Pressure (hPa)	Pressure (psia)
10000	32808	264.4	3.83
12000	39370	192.9	2.80
12192	40000	186.9	2.71
13000	42650	163.5	2.37
14000	45931	137.9	2.00
15000	49212	115.6	1.68
16000	52493	96.4	1.40
16764	55000	83.5	1.21
18000	59054	65.6	0.95
20000	65616	43.3	0.63

Translation dBm into Watt

+90 dBm	1.000 000 W	10 ⁶	1 Megawatt
+80 dBm	100.000 W	10 ⁵	100 Kilowatt
+70 dBm	10.000 W	10 ⁴	10 Kilowatt
+60 dBm	1.000 W	10 ³	1 Kilowatt
+50 dBm	100 W	10 ²	100 Watt
+40 dBm	10 W	10 ¹	10 Watt
+30 dBm	1 W	10 ⁰	1 Watt
+20 dBm	0.1 W	10 ⁻¹	100 Milliwatt
+10 dBm	0.01 W	10 ⁻²	10 Milliwatt
0 dBm	0.001 W	10 ⁻³	1 Milliwatt
-10 dBm	0.000 1 W	10 ⁻⁴	100 Microwatt
-20 dBm	0.000 01 W	10 ⁻⁵	10 Microwatt
-30 dBm	0.000 001 W	10 ⁻⁶	1 Microwatt
-40 dBm	0.000 000 1 W	10 ⁻⁷	100 Nanowatt
-50 dBm	0.000 000 01 W	10 ⁻⁸	10 Nanowatt
-60 dBm	0.000 000 001 W	10 ⁻⁹	1 Nanowatt

Technical Annex

Waveguide designations			Internal dimensions		Frequency		Band	
IEC ¹	EIA ²	UK ³	Metric ¹ mm	Imperial ¹ inches	Nominal range ¹ GHz	TE ₁₀ cut-off ⁴ GHz	Most common use	Other common use
R 3	WR 2300	WG 00	584.20 x 292.10	23.000 x 11.500	0.32 - 0.49	0.257	-	-
R 4	WR 2100	WG 0	533.40 x 266.70	21.000 x 10.500	0.35 - 0.53	0.281	-	-
R 5	WR 1800	WG 1	457.20 x 228.60	18.000 x 9.000	0.41 - 0.62	0.328	-	-
R 6	WR 1500	WG 2	381.00 x 190.50	15.000 x 7.500	0.49 - 0.75	0.393	-	-
R 8	WR 1150	WG 3	292.10 x 146.05	11.500 x 5.750	0.64 - 0.98	0.513	-	-
R 9	WR 975	WG 4	247.65 x 123.82	9.750 x 4.875	0.76 - 1.15	0.605	-	-
R 12	WR 770	WG 5	195.58 x 97.79	7.700 x 3.850	0.96 - 1.46	0.766	-	-
R 14	WR 650	WG 6	165.10 x 82.55	6.500 x 3.250	1.13 - 1.73	0.908	L	-
R 18	WR 510	WG 7	129.54 x 64.77	5.100 x 2.550	1.45 - 2.20	1.157	-	-
R 22	WR 430	WG 8	109.22 x 54.61	4.300 x 2.150	1.72 - 2.61	1.372	-	Ls, R
R 26	WR 340	WG 9A	86.36 x 43.18	3.400 x 1.700	2.17 - 3.30	1.736	-	-
R 32	WR 284	WG 10	72.14 x 34.04	2.840 x 1.340	2.60 - 3.95	2.078	S	-
R 40	WR 229	WG 11A	58.17 x 29.08	2.290 x 1.145	3.22 - 4.90	2.577	-	-
R 48	WR 187	WG 12	47.549 x 22.149	1.872 x 0.872	3.94 - 5.99	3.152	C	G
R 58	WR 159	WG 13	40.386 x 20.193	1.590 x 0.795	4.64 - 7.05	3.712	-	C
R 70	WR 137	WG 14	34.849 x 15.799	1.372 x 0.622	5.38 - 8.17	4.301	-	Xn, J
R 84	WR 112	WG 15	28.499 x 12.624	1.122 x 0.497	6.57 - 9.99	5.260	-	Xb, H
R 100	WR 90	WG 16	22.860 x 10.160	0.900 x 0.400	8.20 - 12.5	6.557	X	-
R 120	WR 75	WG 17	19.050 x 9.525	0.750 x 0.375	9.84 - 15.0	7.869	-	M
R 140	WR 62	WG 18	15.799 x 7.899	0.622 x 0.311	11.9 - 18.0	9.488	Ku	P
R 180	WR 51	WG 19	12.954 x 6.477	0.510 x 0.255	14.5 - 22.0	11.571	-	N
R 220	WR 42	WG 20	10.668 x 4.318	0.420 x 0.170	17.6 - 26.7	14.051	K	-
R 260	WR 34	WG 21	8.636 x 4.318	0.340 x 0.170	21.7 - 33.0	17.357	-	-
R 320	WR 28	WG 22	7.112 x 3.556	0.280 x 0.140	26.3 - 40.0	21.077	Ka	R
R 400	WR 22	WG 23	5.690 x 2.845	0.224 x 0.112	32.9 - 50.1	26.344	Q	-
R 500	WR 19	WG 24	4.775 x 2.388	0.188 x 0.094	39.2 - 59.6	31.392	U	-
R 620	WR 15	WG 25	3.759 x 1.880	0.148 x 0.074	49.8 - 75.8	39.877	V	-
R 740	WR 12	WG 26	3.099 x 1.549	0.122 x 0.061	60.5 - 91.9	48.372	E	-
R 900	WR 10	WG 27	2.540 x 1.270	0.100 x 0.050	73.8 - 112.0	59.014	W	-
R 1200	WR 8	WG 28	2.032 x 1.016	0.080 x 0.040	92.2 - 140.0	73.768	F	-
R 1400	WR 7 ⁵ (WR 6.5)	WG 29	1.6510 x 0.8255	0.0650 x 0.0325	113.0 - 1730	90.791	D	-
R 1800	WR 5 (WR 5.1)	WG 30	1.2954 x 0.6477	0.0510 x 0.0255	145.0 - 220.0	115.71	G	-
R 2200	WR 4 (WR 4.3)	WG 31	1.0922 x 0.5461	0.0430 x 0.0215	172.0 - 261.0	137.24	-	-
R 2600	WR 3 (WR 3.4)	WG 32	0.8636 x 0.4318	0.0340 x 0.0170	217.0 - 330.0	173.57	-	-

¹ IEC 153-2, Hollow metallic waveguides, Part 2: Relevant specifications for ordinary rectangular waveguides, Standard of the International Electrotechnical Commission, 1974

² EIA RS-261-B, rectangular waveguides (WR 3 to WR 2300), Standard of the Electronic Industries Association of the USA, May 1979

³ MOD UK DEF-5351, Specification for tubing, waveguide; Standard of the Ministry of Defence of the United Kingdom

⁴ The cut-off frequency is given by $f_c = c_0/(2a)$ with $c_0 = 299792458 \text{ ms}^{-1}$ and the waveguide width

⁵ This waveguide is sometimes referred to as WR 6

You can find the current versions of this unit conversion at:

www.spinner-group.com/en/download (TD-00036)



VSWR Conversion Table

VSWR	Reflection (r)	Return loss (dB)
1.010	0.005	46.1
1.015	0.007	42.6
1.020	0.010	40.1
1.025	0.012	38.2
1.030	0.015	36.6
1.035	0.017	35.3
1.040	0.020	34.2
1.045	0.022	33.1
1.050	0.024	32.3
1.055	0.027	31.4
1.060	0.029	30.7
1.065	0.031	30.0
1.070	0.034	29.4
1.075	0.036	28.8
1.080	0.038	28.3
1.085	0.041	27.8
1.090	0.043	27.3
1.095	0.045	26.9
1.100	0.048	26.4
1.110	0.052	25.7
1.120	0.057	24.9
1.130	0.061	24.3
1.140	0.065	23.7
1.150	0.070	23.1
1.160	0.074	22.6
1.170	0.078	22.1
1.180	0.083	21.7
1.190	0.087	21.2
1.200	0.091	20.8
1.210	0.095	20.4
1.220	0.099	20.1
1.230	0.103	19.7
1.240	0.107	19.4
1.250	0.111	19.1
1.260	0.115	18.8
1.270	0.119	18.5
1.280	0.123	18.2
1.290	0.127	17.9
1.300	0.130	17.7
1.310	0.134	17.4
1.320	0.138	17.2
1.330	0.142	17.0
1.340	0.145	16.8
1.350	0.149	16.5
1.360	0.153	16.3
1.370	0.156	16.1
1.380	0.160	15.9
1.390	0.163	15.7
1.400	0.167	15.6
1.410	0.170	15.4
1.420	0.174	15.2

VSWR	Reflection (r)	Return loss (dB)
1.430	0.177	15.0
1.440	0.180	14.9
1.450	0.184	14.7
1.460	0.187	14.6
1.470	0.190	14.4
1.480	0.194	14.3
1.490	0.197	14.1
1.500	0.200	14.0
1.510	0.203	13.8
1.520	0.206	13.7
1.530	0.209	13.6
1.540	0.213	13.4
1.550	0.216	13.3
1.560	0.219	13.2
1.570	0.222	13.1
1.580	0.225	13.0
1.590	0.228	12.8
1.600	0.231	12.7
1.610	0.234	12.6
1.620	0.237	12.5
1.630	0.240	12.4
1.640	0.242	12.3
1.650	0.245	12.2
1.660	0.248	12.1
1.670	0.251	12.0
1.680	0.254	11.9
1.690	0.257	11.8
1.700	0.259	11.7
1.710	0.262	11.6
1.720	0.265	11.5
1.730	0.267	11.5
1.740	0.270	11.4
1.750	0.273	11.3
1.760	0.275	11.2
1.770	0.278	11.1
1.780	0.281	11.0
1.790	0.283	11.0
1.800	0.286	10.9
1.810	0.288	10.8
1.820	0.291	10.7
1.830	0.293	10.7
1.840	0.296	10.6
1.850	0.298	10.5
1.860	0.301	10.4
1.870	0.303	10.4
1.880	0.306	10.3
1.890	0.308	10.2
1.900	0.310	10.2
1.910	0.313	10.1
1.920	0.315	10.0
1.930	0.317	10.0





Notes

A series of horizontal lines for taking notes, consisting of 25 evenly spaced lines across the page.



Notes

Lined area for taking notes, consisting of numerous horizontal grey lines.



HIGH FREQUENCY PERFORMANCE WORLDWIDE

SPINNER designs and builds cutting-edge radio frequency systems, setting performance and longevity standards for others to follow. The company's track record of innovation dates back to 1946, and many of today's mainstream products are rooted in SPINNER inventions.

Industry leaders continue to count on SPINNER's engineering excellence to drive down their costs of service and ownership with premium-quality, off-the-shelf products and custom solutions. Headquartered in Munich, Germany, the global frontrunner in RF components remains the first choice in simple-yet-smart RF solutions.

www.spinner-group.com

SPINNER GmbH

Headquarters

Erzgiessereistr. 33
80335 Munich
GERMANY
Phone: +49 89 12601-0
info@spinner-group.com

SPINNER Austria GmbH

Modecenterstr. 22/C38
1030 Vienna
AUSTRIA
Phone: +43 1 66277 51
info-austria@spinner-group.com

SPINNER Electrotécnica S.L.

c/ Perú, 4 – Local nº 15
28230 Las Rozas (Madrid)
SPAIN
Phone: +34 91 6305 842
info-iberia@spinner-group.com

SPINNER France S.A.R.L.

24 Rue Albert Priolet
78100 St. Germain en Laye
FRANCE
Phone: +33 1 74 13 85 24
info-france@spinner-group.com

SPINNER ICT Inc.

2220 Northmont Parkway, 250
Duluth, GA 30096
USA
Phone: +1 770 2636 326
info@spinner-group.com

SPINNER Nordic AB

Kråketorpsgatan 20
43153 Mölndal
SWEDEN
Phone: +46 31 7061670
info-nordic@spinner-group.com

SPINNER Telecommunication

Devices (Shanghai) Co., Ltd.
351 Lian Yang Road
Songjiang Industrial Zone
Shanghai 201613
P.R. CHINA
Phone: +86 21 577 45377
info-china@spinner-group.com

SPINNER UK Ltd.

Suite 8 Phoenix House
Golborne Enterprise Park,
High Street
Golborne, Warrington
WA3 3DP
UNITED KINGDOM
Phone: +44 1942 275222
info-uk@spinner-group.com