

APD89C



POWER
YOUR
FUTURE

89 kVA / 71.2 kW
POWERED BY CUMMINS

DIESEL GENERATING SET 400/230 V - 50 Hz - 3 Phase

MODEL			APD89C
Power Pf. 0.8	Standby	kVA	89
		kW	71.2
	Prime	kVA	78
		kW	62.4

Standby: Continuous running at variable load for duration of an emergency. No overload is permitted on these ratings. In accordance with ISO 3046.
Prime: Continuous running at variable load for unlimited periods with 10% overload available for 1 hour in any 12 hour period. In accordance with ISO 8528,ISO 3046.

- ✓ High quality, reliable and complete power unit
- ✓ Compact design
- ✓ Easy start and maintenance possibility
- ✓ Every generating set is subject to a comprehensive test program which includes full load testing, checking and provision of all control and safety shut down functions testing
- ✓ Fully engineered with a wide range of options and accessories: Canopy, sound proof canopy and on-road trailer



Manufacturer reserves the right to make changes in model, technical specifications, color, equipment and accessories without prior notice.

ENGINE

CUMMINS		
Model		4BTA3.9G11
Engine Power Output at rated rpm	kWm	80
	HP	107
Aspiration and Cooling		Turbocharged & Aftercooled
Total Displacement	Litre	3.9
No. of Cylinders and Build		4 - Inline
Engine Speed	rpm	1500
Bore and Stroke	mmxmm	102x120
Compression Ratio		17.3:1
Governor		Electronic
Fuel Consumption at full load	L/hr	17.6
Fuel Tank Capacity	Litre	180
Oil Capacity	Litre	10.9
Coolant Capacity	Litre	22.3
Radiator Cooling Air	m ³ /min	120
Air Intake – Engine	m ³ /min	4.2
Exhaust Gas Flow	m ³ /min	8.04

- ✓ Heavy duty Cummins diesel engine
- ✓ Four stroke, water cooled, turbocharged & aftercooled
- ✓ Direct injection fuel system
- ✓ Electronic Governor system
- ✓ 12/24 V D.C. starter and charge alternator
- ✓ Replaceable fuel filter, oil filter and dry element air filter
- ✓ Cooling radiator and fan
- ✓ Starter battery (with lead acid) including Rack and Cables
- ✓ Flexible fuel connection hoses and manual oil sump drain valve
- ✓ Industrial capacity exhaust silencer and steel bellows
- ✓ Jacket water heater(at automatic models)
- ✓ Operation manuals and circuit diagram documents

ALTERNATOR

Design	Brushless single bearing, revolving field
Stator	2/3 pitch
Rotor	Single bearing, flexible disc
Insulation System	Class H
Standard Temperature Rise	125 - 163°C Continuous
Exciter Type	Self Excited
Phase Rotation	A (U), B (V), C (W)
Alternator Cooling	Direct drive centrifugal blower fan
AC Waveform Total Harmonic Distortion	No load < 1.5%. Non distorting balanced linear load < 5%
Telephone Influence Factor (TIF)	<50 per NEMA MG1-22.43
Telephone Harmonic Factor (THF)	<2%

- ✓ Brushless, single bearing system, flexible disc, 4 poles
- ✓ Insulation class H
- ✓ Standard degree of protection IP21 (*IP22/IP23 is available.)
- ✓ Self-exciting and self-regulating
- ✓ Impregnation with tropicalised epoxy varnish
- ✓ Solid state Automatic Voltage Regulator
- ✓ Stator winding with 2/3 pitch for improved harmonics

CONTROL SYSTEM

Control supervision and protection panel is mounted on the genset base frame. The control panel is equipped as follows:

1. Auto Mains Failure Control Panel

Panel equipments:

- ✓ Control with AMF module
- ✓ Static battery charger
- ✓ Emergency stop push button

a) Generating set control module DSE6120 features:

- ✓ The module is used to monitor main supply and starts and stops of a standby generating set
 - ✓ Micro-processor based design
 - ✓ Automatic control of main and generator contactors
 - ✓ Monitors engine performance and AC power output LED alarm indication
 - ✓ Front panel configuration of timers and alarm trip points
 - ✓ 4 configurable analogue/digital inputs, 8 configurable digital inputs
 - ✓ 6 configurable DC outputs
 - ✓ Easy push button control
- STOP/RESET - MANUAL - AUTO - TEST – START

b) Metering via LCD display:

- ✓ Generator Volts (L-L / L-N)
 - ✓ Engine oil pressure (PSI-Bar)
 - ✓ Generator Ampere (L1,L2,L3)
 - ✓ Engine temperature (° C & ° F)
 - ✓ Generator Frequency (Hz)
 - ✓ Plant battery volts
 - ✓ Engine hours run
 - ✓ Mains Volts (Ph-Ph/Ph-N)
- Generator kVA
 - Generator kW
 - Generator Cos (σ)



DSE 6120

c) Alarms:

- ✓ Over and Under Speed
- ✓ Low and High Battery Volt.
- ✓ Start and Stop Failure
- ✓ Charge fail
- ✓ Over Current
- ✓ Under / Over Generator Voltage
- ✓ Low Oil Pressure
- ✓ Emergency stop
- ✓ High engine temperature

d) LED indications

- ✓ Mains available
- ✓ Generator available
- ✓ Mains on load
- ✓ Generator on load

2. Power Outlet Terminal Board Mounted on the Gen-set Base Frame

OPTIONAL EQUIPMENTS

Diesel Engine

- ✓ Oil heater

Alternator

- ✓ 3/4 Pole Output Circuit Breaker
- ✓ Anti-condensation Heater

Panel

- ✓ Charge ammeter
- ✓ Transfer Switch 3 Pole
- ✓ Transfer Switch 4 Pole
- ✓ Earth Fault, single set

Accessories

- ✓ Bulk fuel tank
- ✓ Automatic filling system
- ✓ Fuel-water separator filter
- ✓ Low fuel level alarm
- ✓ Residential silencer
- ✓ Enclosure or sound proof canopy
- ✓ Trailer
- ✓ Manual oil drain pump
- ✓ Tool kit for maintenance

CHASSIS

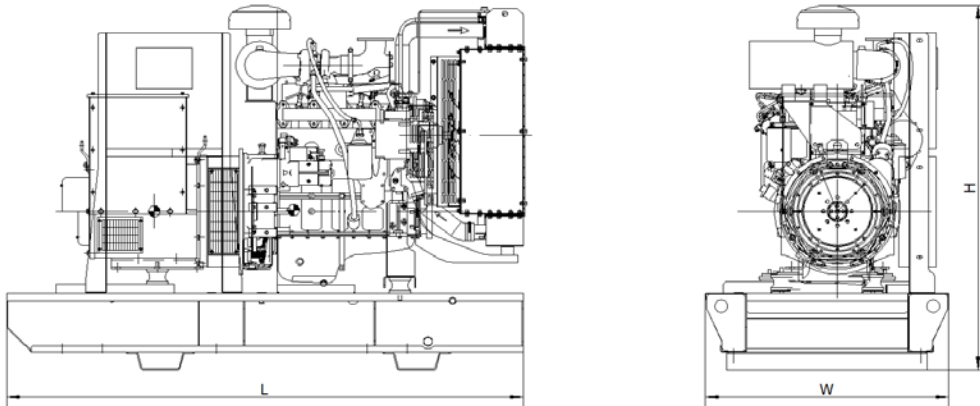

- ✓ The complete gen-set is mounted as whole on a heavy-duty fabricated, steel base frame
- ✓ Anti-vibration pads are fixed between the engine/ alternator feet and the base frame
- ✓ Base frame design incorporates an integral fuel tank (Up to 1000 kVA)
- ✓ The generating set can be lifted or carefully pushed / pulled by the base frame
- ✓ Dial type fuel gauge and drain plug on the fuel tank
- ✓ Forklift pockets within base frame (up to 500kVA)

DIMENSIONS

OPEN TYPE

DIMENSIONS (LxWxH)	mm	2015x950x1420
DRY WEIGHT	kg	1080

SOUND ATTENUATED TYPE

DIMENSIONS (LxWxH)	mm	2282x1008x1532
DRY WEIGHT	kg	1300

CANOPY

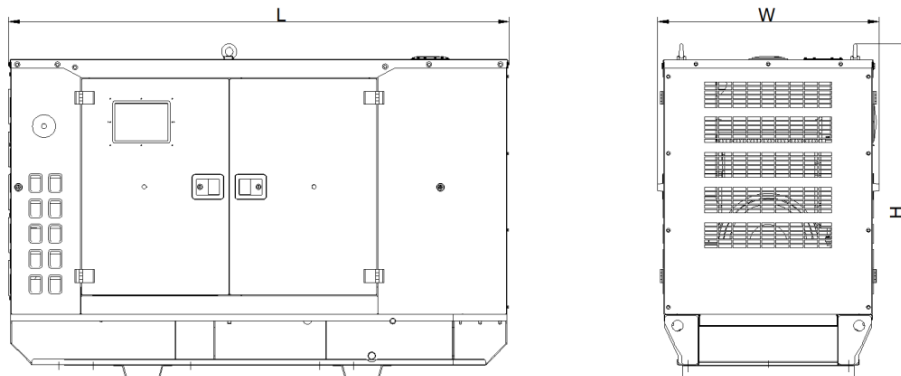

- ✓ All canopy parts are designed with modular principles
- ✓ Without welding assembly
- ✓ Doors on each side
- ✓ All metal canopy parts are painted by electrostatic polyester powder paint
- ✓ Exhaust silencer is protected against environment influences
- ✓ Thermally insulated engine exhaust system
- ✓ Emergency stop push button is installed outside of the canopy
- ✓ Easy lifting and moving
- ✓ Easy maintenance and operation

Aksa Power Generation

Ruzgarlibahce Mahallesi - Özalp Cikmazi No:10 34805 Kavacik Beykoz - Istanbul / Turkey

Tel:+90 212 444 46 30 E-mail: aksa@aksapowergen.com

www.aksapowergen.com

Aksa Power Generation is a member of  KAZANCI HOLDING www.aksa.com.tr