

Beach

L I G H T I N G



www.beachlightingusa.com

CONTENTS

MICRO SPOTLIGHT SERIES	Page #
<hr/>	
MICRO SERIES AND ACCESSORIES	8
COB LED RECESSED LIGHTING	
<hr/>	
2" LED COB LIGHTS	12
2.5" LED COB LIGHTS	20
3" LED COB LIGHTS	22
3.5" LED COB LIGHTS	24
4" LED COB LIGHTS	28
NEW CONSTRUCTION PLATES	32
MULTIPLE RECESSED LIGHTING	
<hr/>	
MICRO LED MULTIPLES	36
COB MULTIPLES	50
GU-10 MULTIPLES	56
SLIM LINE RECESSED PANELS	
<hr/>	
90° ROTATING SLIM SERIES	62
4" AND 6" LED PANELS	70
4" LED ADJUSTABLE PANELS	79
BACK LITE PANELS	86
DESIGNER LED PANELS	94
3" RECESSED LIGHTING	
<hr/>	
3" DESIGNER TRIMS	98
3" RECESSED TRIMS	99
3" DIE CAST TRIMS	103
3" SHOWER TRIMS	105
3" LINE VOLTAGE HOUSINGS	106
4" RECESSED LIGHTING	
<hr/>	
4" DESIGNER TRIMS	110
4" RECESSED TRIMS	111
4" DIE CAST TRIMS	116
4" SHOWER TRIMS	118
4" TRIM-LESS TRIMS	120
4" LINE VOLTAGE HOUSINGS	122
UNDERCOUNTER LIGHTING	
<hr/>	
WAVE KITS	126
WAVE LIGHTS	127
CONNECTORS / CONTROLS	128
POWER SUPPLIES	129
LED LAMPS	
<hr/>	
GU-10 LED	132
Dimmer Compatibility	133
Accessories	134



MXL-16W-3D90

8

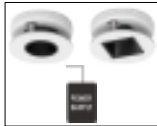

MXL-ACCESSORIES

9

COB LED RECESSED LIGHTING SERIES



R2R-IC-9.5COB-3D90-MW

12



R2RG-IC-9.5COB-3D90-MW

13



R2S-IC-9.5COB-3D90-MW

14



R2SG-IC-9.5COB-3D90-MW

15



RA2R-IC-15W-3D90-MW

16



RA2S-IC-15W-3D90-MW

18



R2.5-SERIES

20



R2.5WD-SERIES

21



R3-47IC-SERIES

22



R3-57IC-SERIES

22



R3.5R-SERIES

24



R3.5RG-SERIES

24



R3.5S-SERIES

26



R3.5SG-SERIES

26



R4-47IC-SERIES

28



R4-57IC-SERIES

28



RA4-IC-15W-3D90

30



R3-NC
R3.5-NC
R4-NC
R5R-NC
R4-6S-NC
R2.5-4-6NC

32

MULTIPLE RECESSED LIGHTING SERIES



NR1L-SERIES

36



NR3L-SERIES

36



NR4SL-SERIES

37



NR9SL-SERIES

37



NR5L-SERIES

38



NR10L-SERIES

38



MR5L-SERIES

40



MR10L-SERIES

41



MR15L-SERIES

42



MR10AL-SERIES

43



MR15AL-SERIES

44



MRS-INSERT-MW

45

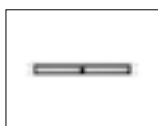

MR10WW-SERIES

46

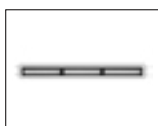

MR15WW-SERIES

47



MH4011COB-SERIES

50



MH4012COB-SERIES

52



MH4013COB-SERIES

54



MH4011RAT-SERIES

56



MH4011AT-SERIES

57



MH4012AT-SERIES

58



MH4013AT-SERIES

59

SLIM LINE RECESSED PANELS



T4R-IC-7W-3D90-MW

62



T4S-IC-7W-3D90-MW

62



T4S2-IC-12W-3D90MW

63



T4S3-IC-15W-3D90-MW

63



L4R-10W-3/4K-DW90-MW

70



L4S-10W-3/4K-DW90-MW

72



L6R-15W-3/4K-DW90-MW

74



L6S-15W-3/4K-DW90-MW

76



L4RO-SERIES

78



L4SSG-SERIES
L6SSG-SERIES

79



RF4-8W-3D-MW

80



F4-10W-SERIES

82



F6-15W-SERIES

83



L4BLR-10W-3/4K-D90-MW

86



L4BLS-10W-3/4K-D90-MW

88



L6BLR-14W-3/4K-D90-MW

90



L6BLS-14W-3/4K-D90-MW 92



L6BLRD-10W-3/4K-D90-MW 94



L6BLRW-10W-3/4K-D90-MW 94



R6-BLR-12RETRO-3D90-MW 95

3" RECESSED LIGHTING SERIES



R3-4765 98



R3-5765 98



R3-421 99



R3-488 99



R3-488DG 99



R3-493 100



R3-521 100



R3-555 100



R3-588 101



R3-588DG 101



R3-590 101



R3-593 102

3" DIE-CAST TRIMS



R3-DR488 103



R3-DR88 103



R3-DS88 103



R3-DS589 104



R3-DS90 104

3" SHOWER TRIMS



R3-409 105



R3-508 105



R3-559 105

3" LINE VOLTAGE HOUSINGS



R3-GUICAT 106



R3-GUICRAT 106

4" RECESSED LIGHTING SERIES



R4-4765 110



R4-5765 110



R4-421 111



R4-488 111



R4-488DG 111



R4-493 112



R4-520 112



R4-521 112



R4-545 113



R4-587 113



R4-588 113



R4-588DG 114



R4-589 114



R4-590 114



R4-593 115

4" DIE-CAST TRIMS



R4-DR488 116



R4-DR88 116



R4-DS88 116



R4-DS90 117



R4-DS589 117

4" RECESSED LIGHTING SERIES

108

4" SHOWER TRIMS



R4-409 118

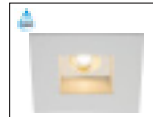

R4-508 119

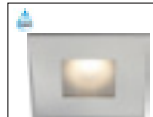

R4-549 119

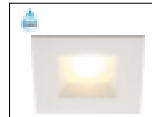

R4-579 119



R4-421TL 120



R4-589TL 120

4" TRIM-LESS TRIMS

4" LINE VOLTAGE HOUSINGS



R4-GUICAT 122



R4-GUICRAT 122



R4-G19SAT 123



R4-G19SRAT 123

UNDERCOUNTER LIGHTING SERIES

124



LUC-2PK 126



LUC-3PK 126



LUC-8-3K 127



LUC-12-3K 127



LUC-24-3K 127



LUC-CONNECTOR 128



LUC-SWITCHES 128



LUC-JUMPER 128



LUC-MOTION 128



LUC-HCC-8 129



LUC-HWB BOX 129



LUC-P PLUG IN 129

LED LAMP SERIES

130



LMGUCCOB-SERIES 132



LTGUCCOB SERIES 132



LBGU-7.5 SERIES 132

ACCESSORIES

134



R-120/277V PS 134



GU-10 WHIP 134



BL-FLEX EXTENSIONS 134



CLIPS 2PK 134



FINISHES



BRUSHED NICKEL
(BN)



MATTE WHITE
(MW)



SATIN NICKEL
(SN)



BRUSHED NICKEL
W/ BLACK (BNB)



MATTE WHITE
W/ ANODIZED
ALUMINUM
(MWA)



BRUSHED NICKEL
W/ CLEAR (BNCL)



MATTE WHITE
W/BLACK (MWB)



CHROME W/ CLEAR
(CCL)



MATTE WHITE
W/CLEAR (MWCL)



www.beachlightingusa.com

LED MICRO SPOTLIGHT AND ACCESSORIES

Beach Lighting Micro Spot Light is a new design of LED light source that provides a cutting edge solution for commercial and architectural lighting. The 1 inch fixture delivers powerful lighting from a small aperture .

MXL-16W-3D90	8
MXL-ACCESSORIES	9







www.beachlightingusa.com

MXL-16W-3D90 LED MICRO SPOTLIGHT



DESCRIPTION

The Micro Spot Light series provides a solution, using cutting edge technology, to achieve an architectural design breakthrough in lighting by using a 1 inch ($\Phi 25\text{mm}$) light-emitting surface delivering a discreet and powerful source of illumination.

FEATURES

Micro Spot Light series with an optional square or round light emission effect. Using high quality COB light sources with high luminous efficiency and long service life (50000 hours). Professional light distribution, no glare, perfect control of light, and even illumination.

Ultra thin design, the height of the whole lamp is less than 1 inch (23mm). Ultra small light emitting surface, only 1 inch ($\Phi 25\text{mm}$).

All-in-one die casting lamp body with unique appearance.

Wide voltage input 120-277VAC, 50/60 Hz, 0-10V dimming, constant voltage and constant current mode.

The power supply is UL listed, can be applied to a variety of applications.

MOUNTING

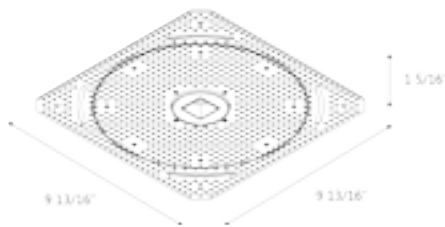

SPECIFICATION		
POWER SUPPLY	Wattage	100W Max.
	Input Voltage	120-277V AC
	Frequency	50/60 Hz
	Output Voltage	24V
	Electric current	3.4A Max.
	Power Factor	>0.9
LAMP	Wattage	16W Max./lamp
	Lumens	1000lm
	Input Voltage	24V
	CCT	3000K
	CRI	90+
	Light source	COB
	Dimming	Dimmable TRAIC
	Certification	ETL
Warranty	3 Year Limited for Fixture & Driver	

Square



MXL series is a 3 part system consisting of fixture, insert and power supply.

LISTING / WARRANTY



ETL listed to US and Canadian standards for damp location W/Feed through.
3 Years Limited Warranty.

TRIM OPTION

REQUIRED INSERTS



Round



Square

MXLR-INSERT-MW
MXLS-INSERT-MW
Matte White With Matte White Baffle

MXLR-INSERT-MWB
MXLS-INSERT-MWB
Matte White With Black Baffle

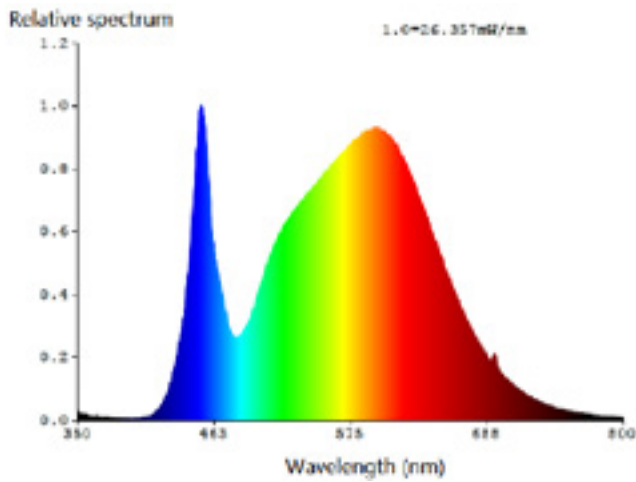

This is the naked test results of the light source and driver.

R4-6S-NC New construction Plate



POWER SUPPLY

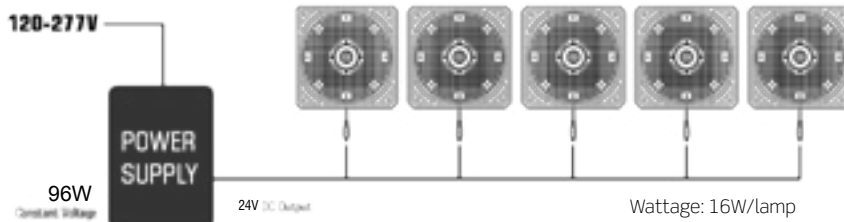

Remote power supply, easy to replace.
The input voltage of each lamp is 24V, they can be used independently or combined based on the total load and corresponding power supply. Luminaire is connected in parallel, one power supply can simultaneously control up to 10 lamps. We recommend 5 lamps per power supply.

POWER SUPPLY: MX96-24VD
MX200-24VD



www.beachlightingusa.com

COB LED RECESSED LIGHTING

2" LED COB lights	12
2.5" LED COB lights	20
3" LED COB lights	22
3.5" LED COB lights	24
4" LED COB lights	28
New construction plates	32







www.beachlightingusa.com

R2R-IC-9.5COB-3D90-MW

2" ROUND RECESSED LIGHT



SPECIFICATION	
LED IC Rated	9.5W
Light Output	630lm
CRI	>90
CCT	3000K
IC	Can Have Direct Contact With Insulation
Location	Damp Location Rated
Dimming	Dimmable Triac /ELV Dimmers
Application	New and Remodel Applications
Finish	Matte White
Certification	ETL

DIMENSIONS

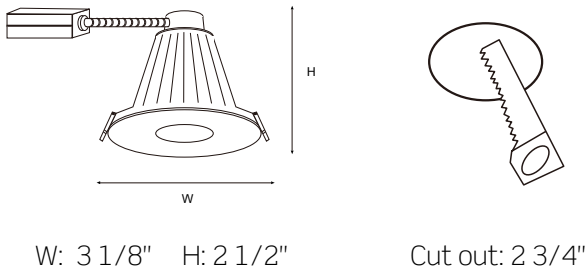

New construction plate included



LISTING / WARRANTY

ETL listed to US and Canadian standards for damp location W/Feed through.
3 Years Limited Warranty.



APPLICATION

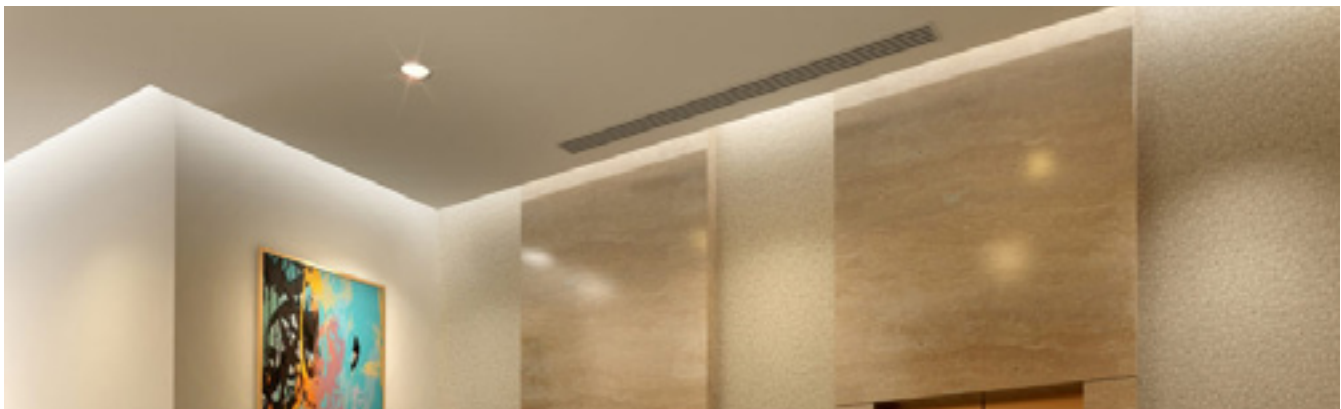



www.beachlightingusa.com

R2RG-IC-9.5COB-3D90-MW

2" ROUND GIMBAL RECESSED LIGHT

COB LED RECESSED



SPECIFICATION

LED IC Rated	9.5W
Light Output	630lm
CRI	>90
CCT	3000K
IC	Can Have Direct Contact With Insulation
Location	Damp Location Rated
Dimming	Dimmable Triac /ELV Dimmers
Application	New and Remodel Applications
Finish	Matte White
Certification	ETL

DIMENSIONS

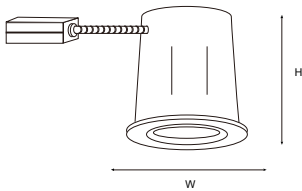

W: 3 1/8" H: 2 1/2"

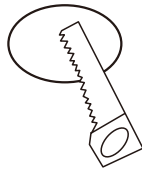

Cut out: 2 3/4"

New construction plate included



LISTING / WARRANTY

ETL listed to US and Canadian standards for damp location W/Feed through.
3 Years Limited Warranty.



APPLICATION

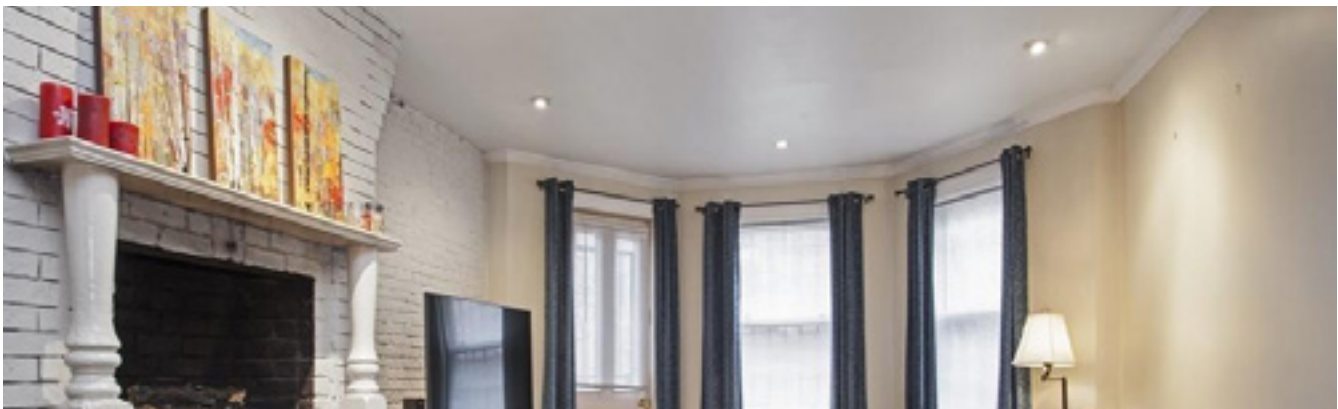



www.beachlightingusa.com

R2S-IC-9.5COB-3D90-MW

2" SQUARE RECESSED LIGHT



SPECIFICATION

LED IC Rated	9.5W
Light Output	630lm
CRI	>90
CCT	3000K
IC	Can Have Direct Contact With Insulation
Location	Damp Location Rated
Dimming	Dimmable Triac /ELV Dimmers
Application	New and Remodel Applications
Finish	Matte White
Certification	ETL

DIMENSIONS

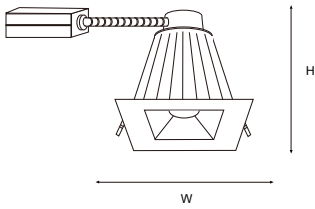

W: 3 1/8" H: 2 1/2"

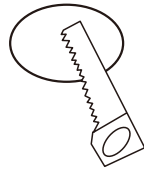

Cut out: 2 3/4"

New construction plate included



LISTING / WARRANTY



ETL listed to US and Canadian standards for damp location W/Feed through.
 ENERGY STAR
 3 Years Limited Warranty.



www.beachlightingusa.com

R2SG-IC-9.5COB-3D90-MW 2 INCH SQUARE GIMBAL RECESSED LIGHT

COB LED RECESSED



SPECIFICATION	
LED IC Rated	9.5W
Light Output	630lm
CRI	>90
CCT	3000K
IC	Can Have Direct Contact With Insulation
Location	Damp Location Rated
Dimming	Dimmable Triac /ELV Dimmers
Application	New and Remodel Applications
Finish	Matte White
Certification	ETL

DIMENSIONS

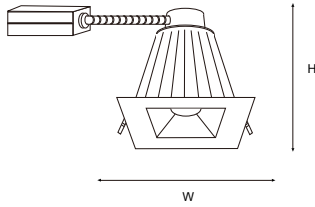

W: 3 1/8" H: 2 1/2"

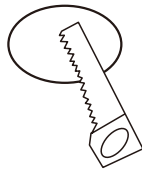

Cut out: 2 3/4"

New construction plate included



LISTING / WARRANTY



ETL listed to US and Canadian standards for damp location W/Feed through.
ENERGY STAR
3 Years Limited Warranty.



www.beachlightingusa.com



RA2R-IC-15W-3D90-MW 2" ROUND CUSTOMIZABLE FIXTURE

SPECIFICATION

Wattage	15W
Light Output	1000lm
Beam Angle	38°
CRI	>90
CCT	3000K
IC	Can Have Direct Contact With Insulation
Location	Damp Location
Dimming	Dimmable Triac /ELV Dimmers
Application	New construction plates available
Certification	ETL / ENERGY STAR
Dimensions	cut out :2 3/4" W: 3 1/18" H: 4 3/8"

ORDERING GUIDE

REFLECTORS

RA2B-AA	Anodize aluminum
RA2B-CHR	Chrome
RA2B-MBK	Matte black

OPTICS

RA2D-24	24 degree beam
RA2D-60	60 degree beam

COLOR TEMPERATURES

RA2C-27K	2700 Kelvin
RA2C-35K	3500 Kelvin
RA2C-4K	4000 Kelvin

TRIMS

RA2T-BN	Brushed nickel
RA2T-BRZ	Bronze
RA2T-CHR	Chrome
RA2T-MBK	Matte black



LISTING / WARRANTY

FOR ADDITIONAL ACCESSORIES SEE PAGE 134



ETL listed to US and Canadian standards for damp location W/Feed through.
ENERGY STAR
3 Years Limited Warranty.



www.beachlightingusa.com

COB LED RECESSED



RA2T-WW-MW
Matte white wall wash



RA2T-SL-MW
Matte white slotted aperture



RA2T-R-MW
Matte white wall round pin hole



RA2T-S-MW
Matte white square pin hole

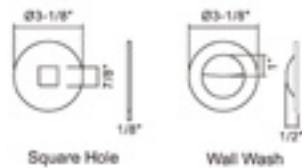
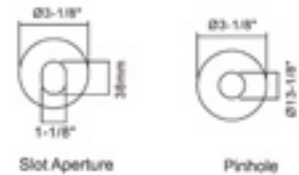
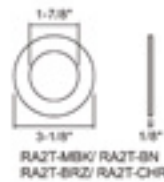
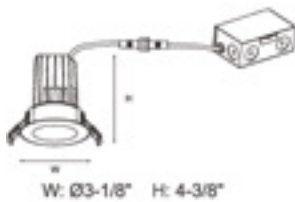

R2.5-4-6-NC New Construction Plate



Photometry

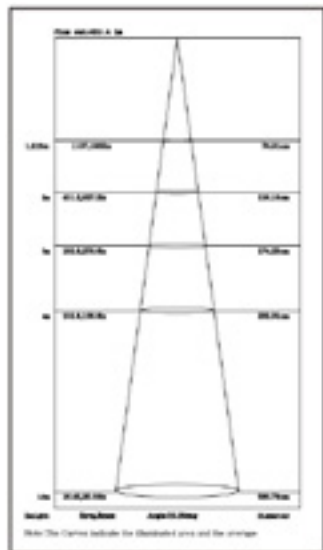

Polar Candela Distribution

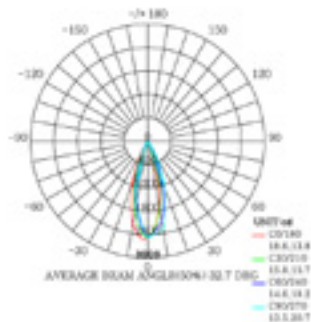

Compatible Dimmers

Brand	Model	Maximum Number of Fixtures per Dimmer
Lutron	PD-6WCL	10
	DVCL-153P	15
	SFTU-53AP	15
	CTCL-153P	15
Leviton	DV-600P	10
	6621	15
	6672	15
Cooper	DSL06	10
	SI06P	15
Pass & Seymour	DMD-LED3-120	10

LISTING / WARRANTY



ETL listed to US and Canadian standards for damp location W/Feed through.
ENERGY STAR
3 Years Limited Warranty.





www.beachlightingusa.com

RA2S-IC-15W-3D90-MW
2" SQUARE REGRESSED FIXTURE



SPECIFICATION	
Wattage	15W
Light Output	1000lm
Beam Angle	38°
CRI	>90
CCT	3000K
IC	Can Have Direct Contact With Insulation
Location	Damp Location
Dimming	Dimmable Triac /ELV Dimmers
Application	New construction plates available
Certification	ETL / ENERGY STAR
Dimensions	cut out :2 3/4" W: 3 1/18" H: 4 3/8"

ORDERING GUIDE

COLOR TEMPERATURES

- RA2C-3.5K 3500 Kelvin
- RA2C-4K 4000 Kelvin



OPTICS

- RA2D-24 24 degree beam spread
- RA2D-60 60 degree beam spread



R2.5-4-6 NC New Construction Plate

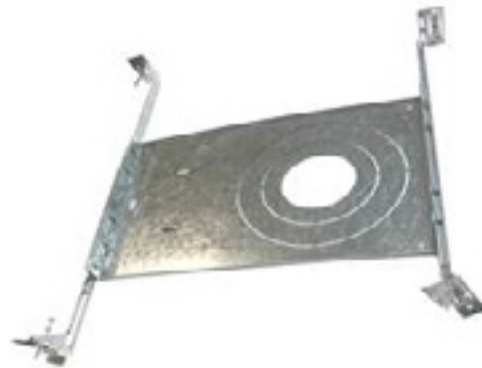

LISTING / WARRANTY

FOR ADDITIONAL ACCESSORIES SEE PAGE 134



ETL listed to US and Canadian standards for damp location W/Feed through.
 ENERGY STAR
 3 Years Limited Warranty.



www.beachlightingusa.com

COB LED RECESSED

DIMENSIONS



WxL: 3-1/8"x3-1/8" H: 4-3/8"



Cut out: 2-3/4"

Photometry

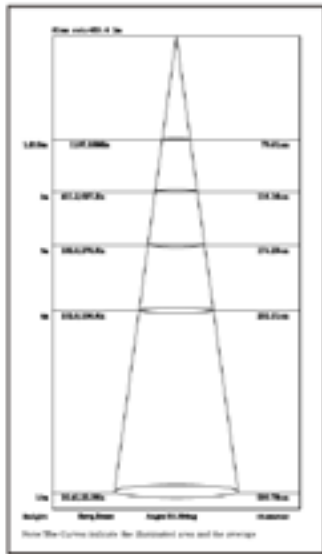

Polar Candela Distribution

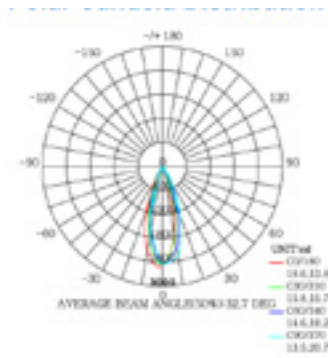

Compatible Dimmers

Brand	Model	Maximum Number of Fixtures per Dimmer
Lutron	PD-6WCL	10
	DVCL-153P	15
	SFTU-53AP	15
	CTCL-153P	15
	DV-600P	10
Leviton	6621	15
	6672	15
	DSL06	10
Cooper	SI06P	15
	Pass & Seymour	DMD-LED3-120



LISTING / WARRANTY



ETL listed to US and Canadian standards for damp location W/Feed through.
ENERGY STAR
3 Years Limited Warranty.





www.beachlightingusa.com

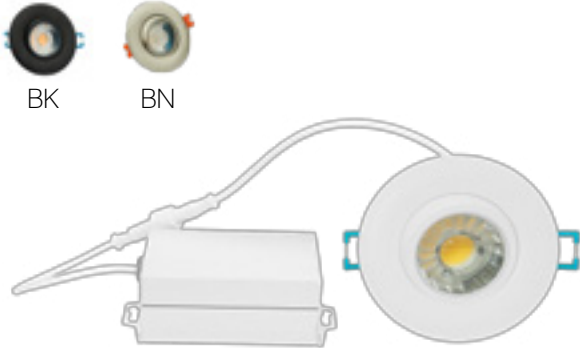

R2.5-ICRAT-3D90-MW

2.5" ROUND REMODEL 360° GIMBAL

SPECIFICATION	
Wattage	8W
Light Output	600lm
CRI	>90
CCT	3000K
IC	Can Have Direct Contact With Insulation
Finish	Brushed Nickel / Black Available
Location	Damp Location
Dimming	Dimmable Triac /ELV Dimmers
Application	New and Remodel Applications
Certification	ETL / ENERGY STAR

DIMENSIONS

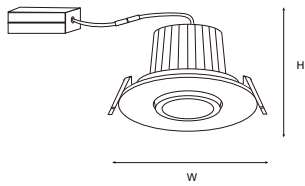

W: 3" H: 1 5/8"

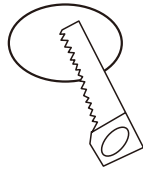

Cut out: 2 3/4"

LISTING / WARRANTY

ETL listed to US and Canadian standards for damp location W/Feed through.
3 Years Limited Warranty.



R2.5-4-6 NC

New Construction Plate

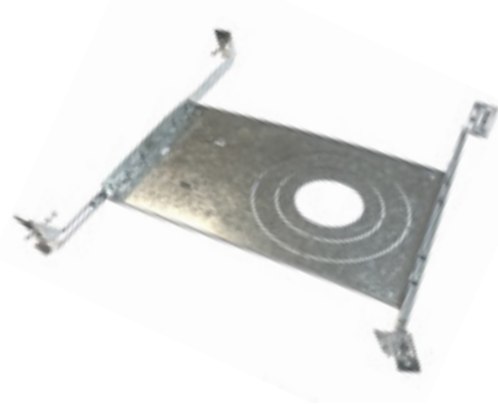

APPLICATION

FOR ADDITIONAL ACCESSORIES SEE PAGE 134





www.beachlightingusa.com

R2.5WD-ICRAT-MW

2.5" ROUND REMODEL 360° GIMBAL

WARM DIM



SPECIFICATION

Wattage	8W
Light Output	600lm
CRI	>90
CCT	3000 to 2700Kelvin
IC	Can Have Direct Contact With Insulation
Location	Damp Location
Dimming	Dimmable Triac /ELV Dimmers
Finish	Matte White
Certification	ETL / ENERGY STAR

COB LED RECESSED

DIMENSIONS

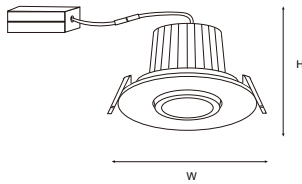

W: 3" H: 1 5/8"

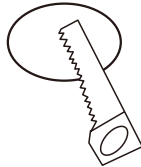

Cut out: 2 3/4"

R2.5-4-6 NC

New Construction Plate

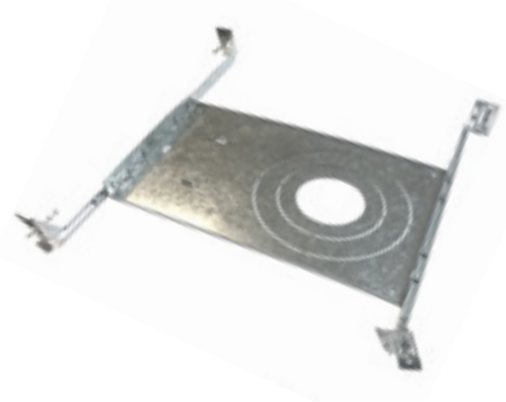

LISTING / WARRANTY

ETL listed to US and Canadian standards for damp location W/Feed through.
3 Years Limited Warranty.



APPLICATION

FOR ADDITIONAL ACCESSORIES SEE PAGE 134





www.beachlightingusa.com

R3-47IC-12COB-3D90-MW

3" ROUND RECESSED LED RETROFIT TRIM



SPECIFICATION

Applications	Recessed Ceiling Mount
Wattage	12W
Light Output	1000lm
CRI	>90
CCT	3000K/4000k
Driver Input	120V AC
Power Factor	0.98
Dimming	TRIAC Dimmers 10%-100% (120V only)
IC	Can Have Direct Contact With Insulation
Location	Damp Location Rated
Finish	Matte White
Certification	ETL / ENERGY STAR
Warranty	3 Year Limited for Fixture & Driver

R3-57IC-12COB-3D90-MW

3" SQUARE RECESSED LED RETROFIT TRIM



DESCRIPTION

Artistic shape downlight with recessed light source that achieves soft, glare free and even illumination. High end diecast aluminum construction is dimmable with most dimming systems. High quality COB chip and isolated power supply, safe and reliable.

FEATURES

Achieves soft lighting without seeing the light source.
No glare and light distortion.
Die cast aluminum body material with good heat dissipation
Higher reflection rate reflector with nano powder sprayed on surface
Uses high grade flame retardant FT4 wire with an independent drive junction box, easy to replace
Can be installed in 0.5" to 1.25" thick ceilings safe isolated power supply
Flicker free stable dimming, can be compatible with multi brand dimmers

LISTING / WARRANTY



ETL listed to US and Canadian standards for damp location W/Feed through.
ENERGY STAR
3 Years Limited Warranty.

MOUNTING

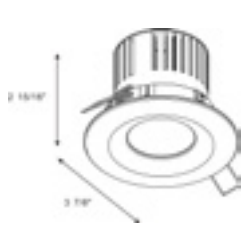

Remodel

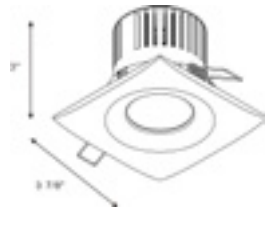

Remodel

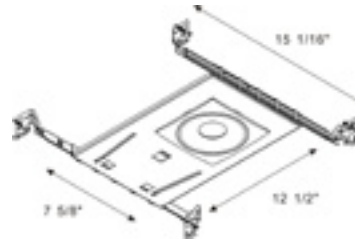

New Construction

R3-NC New Construction Plate



Cut out: 3.07"

OPTION



R-120-277V PS

- 120-277 V Power supply
- Dimmable with 0-10 volts dimmers only

LIGHT DISTRIBUTION CURVE

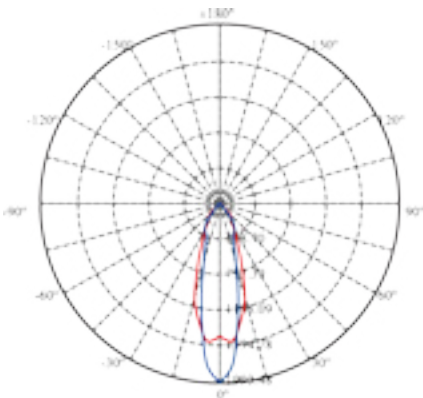

C90(Max): —
 C0-C180: —
 C90-C270: —
 Field angle (10%lmax): C0-180 Left: 47.6 Right: 37.6
 C90-270 Left: 37.3 Right: 37.3
 Beam Angle (50%lmax): C0-180 Left: 24.2 Right: 14.2
 C90-270 Left: 11.7 Right: 11.7

1.0m	1993.5 , 1499.3 lx	45.70cm
2.0m	498.4 , 374.8 lx	91.40cm
3.0m	221.5 , 166.6 lx	137.09cm
4.0m	124.6 , 93.7 lx	182.79cm
5.0m	79.7 , 60.0 lx	228.49cm
6.0m	55.4 , 41.6 lx	274.19cm
7.0m	40.7 , 30.6 lx	319.88cm
8.0m	31.1 , 23.4 lx	365.58cm
9.0m	24.6 , 18.5 lx	411.28cm
10.0m	19.9 , 15.0 lx	456.98cm

Max , Ave Beam angle of C90plane: 25.74



www.beachlightingusa.com



R3.5RG-12W-3D90-MW

3.5" 12W LED ROUND REGRESSED GIMBAL DOWNLIGHT



DESCRIPTION

The Beach Lighting 3.5" 12W recessed downlight LED light fixture for recessed retrofit application. It is a high-performance, easy to install residential grade downlight solution that offers good light output, energy-efficiency Suitable for damp locations.

R3.5R-12W-3D90-MW

3.5" 12W LED ROUND REGRESSED DOWNLIGHT

SPECIFICATION	
Applications	Ceiling Recessed Mount
Approved Location	Damp
Wattage	12W
Beam Angle	38°
CCT	3000K
Certification	cETLus
Class II	Yes
Colour	Matte White
CRI	90
Dimming	Yes
Dimming Tech	TRIAC/ELV
Input	AC120V 50/60HZ
LM79	Yes
LMBO	Yes
Lumens	885
Lumens per Watt	73.7
Power Factor	>0.9
Projected Life	70% @ 50,000 hrs
Warranty	3 years

FEATURES

Body: Durable airtight die-cast aluminum body.

Mounting: Includes two spring loaded clips to attached to any ceiling material.

LED Characteristics: This general app ht fixture features a 12watt LED module that maintains uniform intensity producing up to 800 lumens; with a typical CRI of 90 and a 50,000 hour life span. Available in 3000K, color temperature.

Dimming: 100%-10% dimming capability. This fixture is compatible with industry standard TRI-AC/ELV dimmers (contact factory for listing of compatible dimmers).

Beam Spread: The fixture lens provides 38° beam spread.

LED Driver: Extruded aluminum hard wire box with 270MA dimmable class II electronic LED driver with AC120V input Includes an 15.7" cable from driver to fixture.

Operating Temperature: -20C -40C

Environment: Suitable for Damp locations.

Suitable for insulated ceiling applications.

FOR ADDITIONAL ACCESSORIES SEE PAGE 134

LISTING / WARRANTY



ETL listed to US and Canadian standards for damp location W/Feed through.
ENERGY STAR
3 Years Limited Warranty.

MOUNTING

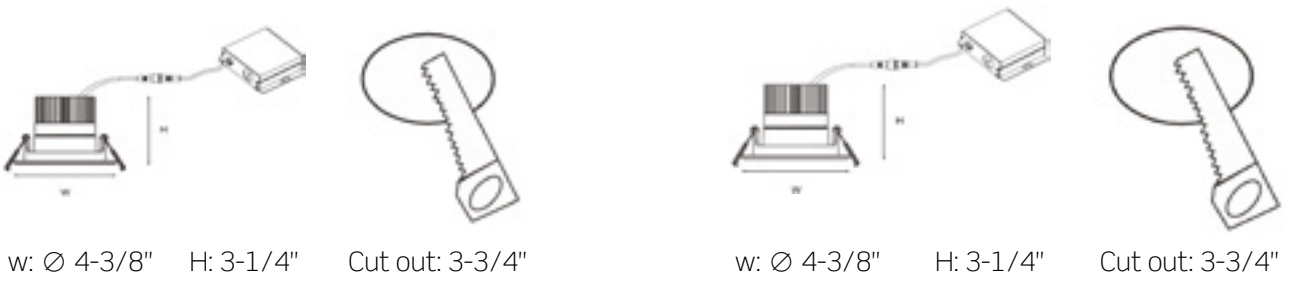

COB LED RECESSED

LIGHT DISTRIBUTION CURVE

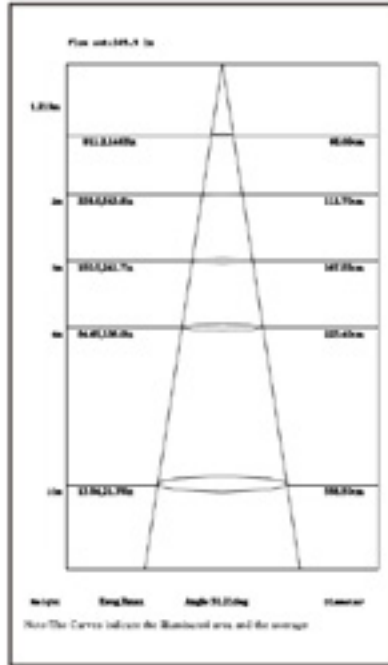
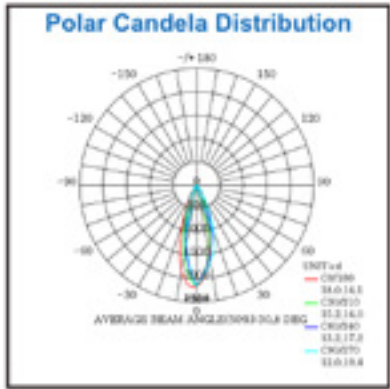

R3.5-NC New Construction Plate



APPLICATION





www.beachlightingusa.com



R3.5SG-12W-3D90-MW

3.5" 12W LED SQUARE REGRESSED
GIMBAL DOWNLIGHT



DESCRIPTION

The Beach Lighting 3.5" 12W recessed downlight LED light fixture or recessed retrofit application. It is a high-performance, easy to install residential grade downlight solution that offers good light output, energy-efficiency Suitable for damp locations.

R3.5S-12W-3D90-MW

3.5" 12W LED SQUARE
REGRESSED DOWNLIGHT

SPECIFICATION

SPECIFICATION	
Applications	Ceiling Recessed Mount
Approved Location	Damp
Wattage	12W
Beam Angle	38°
CCT	3000K
Certification	cETLus
Class II	Yes
Colour	Matte White/Brushed Nickel/Black
CRI	90
Dimming	Yes
Dimming Tech	TRIAC/ELV
Input	AC120V 50/60HZ
LM79	Yes
LMBO	Yes
Lumens	885
Lumens per Watt	73.7
Power Factor	>0.9
Projected Life	70% @ 50,000 hrs
Warranty	3 years

FEATURES

Body: Durable airtight die-cast aluminum body.

Mounting: Includes two spring loaded clips to attach to any ceiling material.

LED Characteristics: This general application light fixture features a 12watt LED module that maintains uniform intensity producing up to 885 lumens;with a typical CRI of 90 and a 50,000 hour life span. Available in 3000K color temperature.

Dimming: 100%-10% dimming capability. This fixture is compatible with industry standard TRI-AC/ELV dimmers (contact factory for listing of compatible dimmers).

Beam Spread: The fixture lens provides 38 beam spread.

LED Driver: Extruded aluminum hard wire box with 270MA dimmable class II electronic LED driver with AC120V input Includes an 15.7" cable from driver to fixture.

Operating Temperature: -20C -40C

Environment: Suitable for Damp locations.

Suitable for insulated ceiling applications

FOR ADDITIONAL ACCESSORIES SEE PAGE 134

LISTING / WARRANTY



ETL listed to US and Canadian standards for damp location W/Feed through.
ENERGY STAR
3 Years Limited Warranty.

MOUNTING

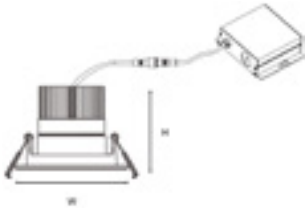

w: 4-3/8" * 4-3/8" H: 3-1/4"



Cut out: 3-3/4"

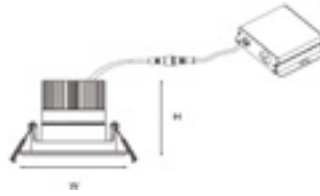

w: Ø 4-3/8" H: 3-1/4"



Cut out: 3-3/4"

LIGHT DISTRIBUTION CURVE

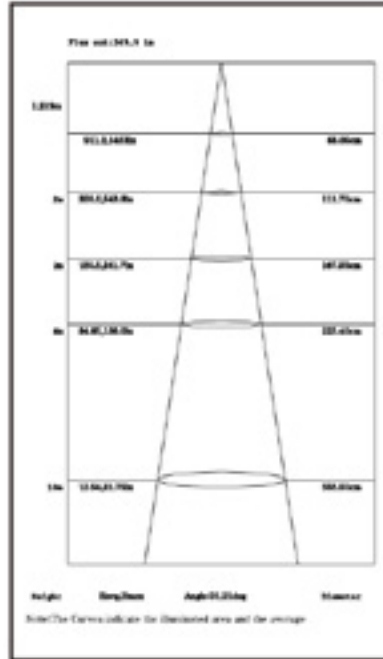
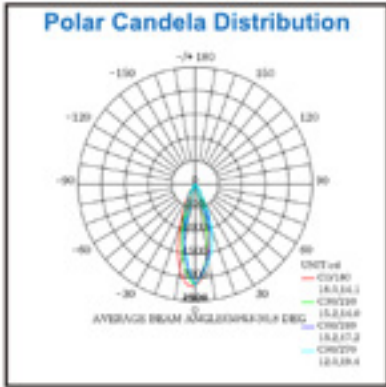

R3.5-NC New Construction Plate



APPLICATION





www.beachlightingusa.com



R4-47IC-15COB-3D90-MW R4-47IC-15COB-4D90-MW 4" ROUND RECESSED LED RETROFIT TRIM

SPECIFICATION

Applications	Recessed Ceiling Mount
Wattage	15W
Light Output	1200lm
CRI	>90
CCT	3000K/4000K
Driver Input	120V / 120-277V AC
Power Factor	0.98
Dimming	120V TRIAC Dimmers 20-277V 0-10 Dimmers
IC	Can Have Direct Contact With Insulation
Location	Damp Location Rated
Finish	Matte White
Certification	ETL / ENERGY STAR
Warranty	3 Year Limited for Fixture & Driver

R4-57IC-15COB-3D90-MW R4-57IC-15COB-4D90-MW 4" SQUARE RECESSED LED RETROFIT TRIM



DESCRIPTION

Artistic shape downlight with recessed light source that achieves soft, glare free and even illumination.
High end diecast aluminum construction is dimmable with most dimming systems.
High quality COB chip and isolated power supply, safe and reliable.

FEATURES

Achieves soft lighting without seeing the light source.
No glare or light distortion.
Die cast aluminum body material with good heat dissipation.
Higher reflection rate reflector with nano powder sprayed on surface
Uses high grade flame retardant FT 4 wire with an independent drive junction box, easy to replace.
Can be installed in 0.5" to 1.25" thick ceilings safe isolated power supply
Flicker free stable dimming, can be compatible with multi brand dimmer.

LISTING / WARRANTY



ETL listed to US and Canadian standards for damp location W/Feed through.
ENERGY STAR
3 Years Limited Warranty.

MOUNTING

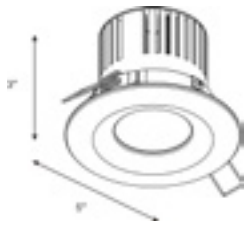

Remodel

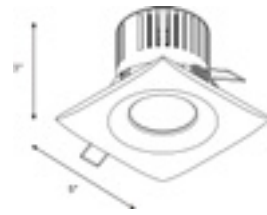

Remodel

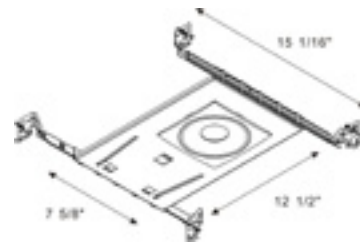

New Construction

R4-NC New Construction Plate

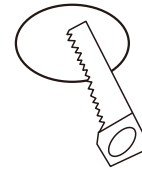

Cut out: 4 3/4"

OPTION



R-120-277V PS

- 120-277 V Power supply
- Dimmable with 0-10 volts dimmers only

LIGHT DISTRIBUTION CURVE

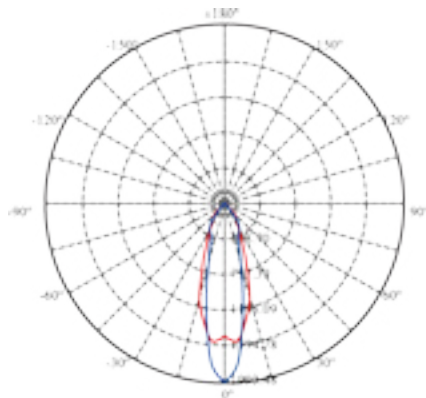

C90(Max): —
 C0/C180: —
 C90/C270: —
 Field angle(10%lmax) C0/180Left:47.6 Right:37.6
 C90/270Left:37.3 Right:37.3
 Beam Angle(50%lmax) C0/180Left:24.2 Right:14.2
 C90/270Left:11.7 Right:11.7

1.0m	1993.5 , 1499.3 lx	45.70cm
2.0m	498.4 , 374.8 lx	91.40cm
3.0m	221.5 , 166.6 lx	137.09cm
4.0m	124.6 , 93.7 lx	182.79cm
5.0m	79.7 , 60.0 lx	228.49cm
6.0m	55.4 , 41.6 lx	274.19cm
7.0m	40.7 , 30.6 lx	319.88cm
8.0m	31.1 , 23.4 lx	365.58cm
9.0m	24.6 , 18.5 lx	411.28cm
10.0m	19.9 , 15.0 lx	456.98cm

Max , Ave Beam angle of C90plane25.74



www.beachlightingusa.com

UNIVERSAL MODULE WITH DRIVER



CHOOSE YOUR STYLE

- RA4-IC-15W-27D90 : 2700 Kelvin
- RA4-IC-15W-3D90 : 3000 Kelvin
- RA4-IC-15W-3.5D90 : 3500 Kelvin
- RA4-IC-15W-4D90 : 4000 Kelvin
- RA4-IC-15W-5D90 : 5000 Kelvin



4" Round Trim

- RA4-RT-MW: Matte White
- RA4-RT-MBK: Matte Black



4" Square Trim

- RA4-ST-MW: Matte White
- RA4-ST-MBK: Matte Black



RA4-IC-15W-3D90

4" 15W LED REGRESS MODULE DOWNLIGHT

2 PART SYSTEM

SPECIFICATION	
Applications	Ceiling Recessed Mount
Approved Location	Damp
Wattage	15W
Beam Angle	120°
CCT	3000K
Certication	cETLus
Class II	Yes
Colour	Matte White/Brushed Nickel/Black
CRI	90
Dimming	Yes
Dimming Tech	TRIAC/ELV
Input	AC120V 50/60HZ
LM79	Yes
LMB0	Yes
Lumens	1000
Lumens per Watt	67
Power Factor	>0.9
Projected Life	70% @ 50,000 hrs
Warranty	3 years

FEATURES

Body: Durable airtight die-cast aluminum body.

Mounting: Includes two spring loaded clips to attached to any ceiling material.

LED Characteristics: This general application light fixture features a 15watt LED module that maintains uniform intensity producing up to 1000 lumens;with a typical CRI of 90 and a 50,000 hour life span. Available in 3000K, 4000K, 5000K color temperature.

Dimming: 100%-10% dimming capability. This fixture is compatible with industry standard TRI-AC/ELV dimmers (contact factory for listing of compatible dimmers).

Beam Spread: The fixture lens provides 38 beam spread.

LED Driver: Extruded aluminum hard wire box with 340MA dimmable class II electronic LED driver with AC120V input. Includes an 15.7" cable from driver to fixture.

Operating Temperature: -20°C ~40°C:

Environment: Suitable for Damp locations.

Suitable for insulated ceiling applications.

LISTING / WARRANTY

FOR ADDITIONAL ACCESSORIES SEE PAGE 134



ETL listed to US and Canadian standards for damp location W/Feed through.
ENERGY STAR
3 Years Limited Warranty.

MOUNTING

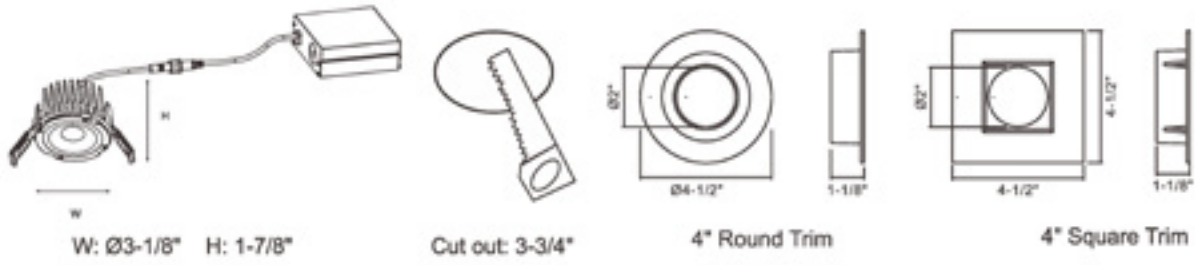

COB LED RECESSED

CUSTOMIZABLE TRIM



R2.5-4-6 NC New Construction Plate

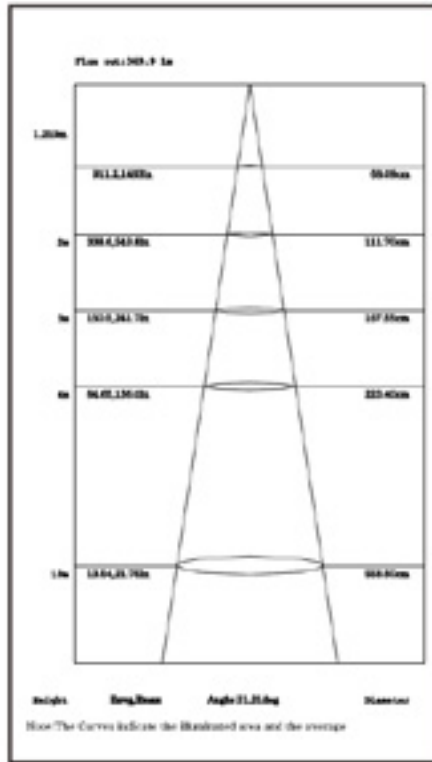
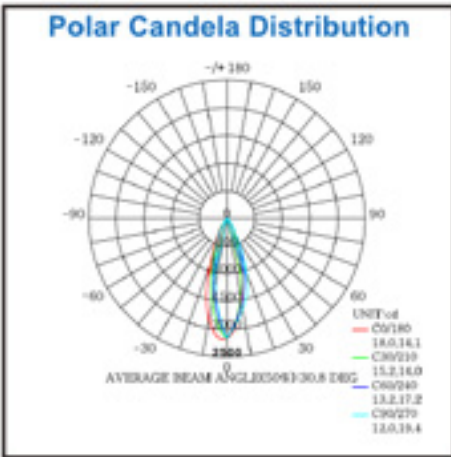



www.beachlightingusa.com

NEW CONSTRUCTION PLATES

R3-NC | R3.5-NC | R4-NC

R5R-NC | R4-6S-NC | R2.5-4-6NC



R3-NC

3" NEW CONSTRUCTION PLATE

- New Construction Plate for 3"
- LED Beach lighting items
- Adapts Remodel housing for New construction application.
- Adjustable steel brackets
- W: 8" L: 18"



R3.5-NC

3.5" New construction plate

- New Construction Plate for 3.5"
- LED Beach lighting items
- Adapts Remodel housing for New construction application.
- Adjustable steel brackets
- W: 8" L: 18"



R4-NC

4" New construction plate

- New Construction Plate for 4"
- LED Beach lighting items
- Adapts Remodel housing for New construction application.
- Adjustable steel brackets
- W: 8" L: 18"



R5R-NC

5" New construction plate

- New Construction Plate for 5"
- LED Beach lighting items
- Adapts Remodel housing for New construction application.
- Adjustable steel brackets
- W: 8" L: 18"



R4-6S-NC

4" OR 6" NEW CONSTRUCTION SQUARE PLATE

- New Construction Plate for 4" or 6" LED Beach Lighting items.
- Adapts Remodel housing for New construction application by detaching break away tabs.
- Adjustable steel brackets
- W: 8" L: 18"

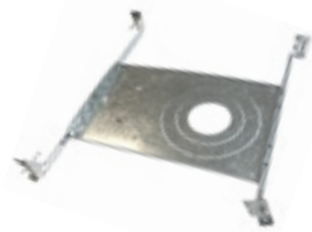

R2.5-4-6NC

MULTIPLE SIZE NEW CONSTRUCTION PLATE

- New Construction Plate for 2.5", 4" or 6" LED downlights or selected slim lines by detaching break away tabs (consult factory for compatible slim lines)
- Adapts Remodel housing for New construction application.
- Adjustable steel brackets
- W: 7 5/8" L: 12"





www.beachlightingusa.com

Efficiently
small
artisan

MULTIPLE RECESSED LIGHTING

Beach Lighting LED multiples combine beautiful aesthetics with optimized performance to set a new benchmark for the category. Featuring a unique patent-pending LED assembly, its novel design enables remarkable tool-free adjustability while maintaining full center beam candle power at all tilt & rotation angles.

Micro LED multiples	36
COB Multiples	50
GU-10 Multiples	56





The ROASTERY

The BEANS

FRESH ARTISAN COFFEE





www.beachlightingusa.com

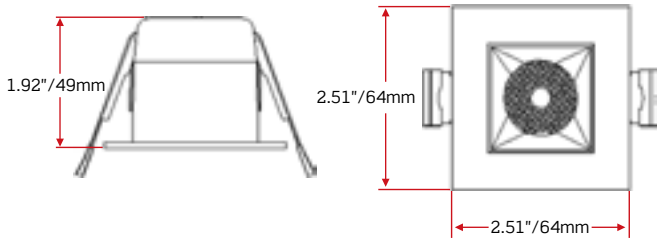

NR-MULTI-NC
New construction plate

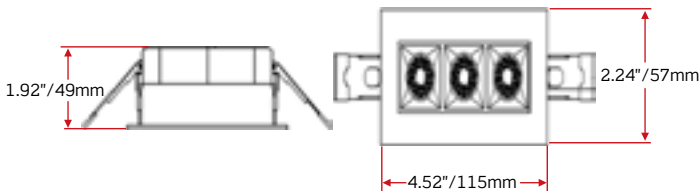
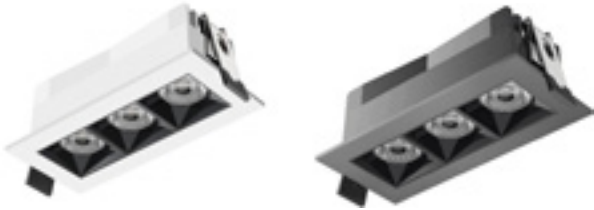

NR1L-5W-3D90-38-GMB
NR1L-5W-3D90-38-GMW
MINI SPOT 1 LIGHT RECESSED LIGHT

SPECIFICATION

Wattage	5 W
Light Output	400LM
Optics	38°
CCT	3000K
Material	Die-Cast Aluminum
Dimming	Triac / ELV Dimmers
Finish	Matte White/Black with Gun Metal Insert
Certification	ETL / DAMP LOCATION
CR!	90 CRI
Cut out	1.85" x 2.16"

NR3L-9W-3D90-38-GMB
NR3L-9W-3D90-38-GMW
MINI SPOT 3 LIGHT RECTANGULAR
RECESSED LIGHT

SPECIFICATION

Wattage	9 W
Light Output	720LM
Optics	38°
CCT	3000K
Material	Die-Cast Aluminum
Dimming	Triac / ELV Dimmers
Finish	Matte White/Black with Gun Metal Insert
Certification	ETL / DAMP LOCATION
Cut out	1.5" x 4.2"

LISTING / WARRANTY

ETL listed to US and Canadian standards for damp location W/Feed through.
3 Years Limited Warranty.

FOR ADDITIONAL ACCESSORIES SEE PAGE 134





www.beachlightingusa.com

NR4SL-12W-3D90-38-GMB
NR4SL-12W-3D90-38-GMW
 MINI SPOT 4 LIGHT RECTANGULAR
 RECESSED LIGHT

LED MICRO MULTIPLES

SPECIFICATION	
Wattage	12 W
Light Output	970LM
Optics	38 °
CCT	3000K
Material	Die-Cast Aluminum
Dimming	Triac / ELV Dimmers
Finish	Matte White/Black with Gun Metal Insert
Certification	ETL / DAMP LOCATION
CRI	90 CRI
Cut out	3" X 3"

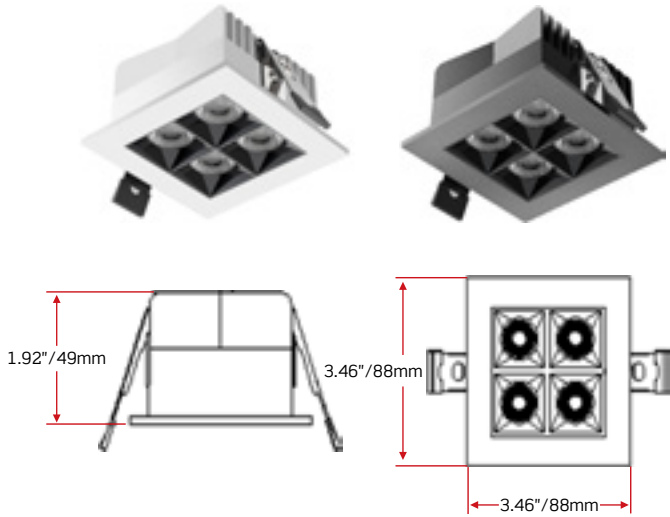

NR-MULTI-NC
 New construction plate

NR9SL-27W-3D90-38-GMB
NR9SL-27W-3D90-38-GMW
 MINI SPOT 9 LIGHT SQUARE RECESSED LIGHT

SPECIFICATION	
Wattage	27 W
Light Output	2160LM
Optics	38 °
CCT	3000K
Material	Die-Cast Aluminum
Dimming	Triac / ELV Dimmers
Finish	Matte White/Black with Gun Metal Insert
Certification	ETL / DAMP LOCATION

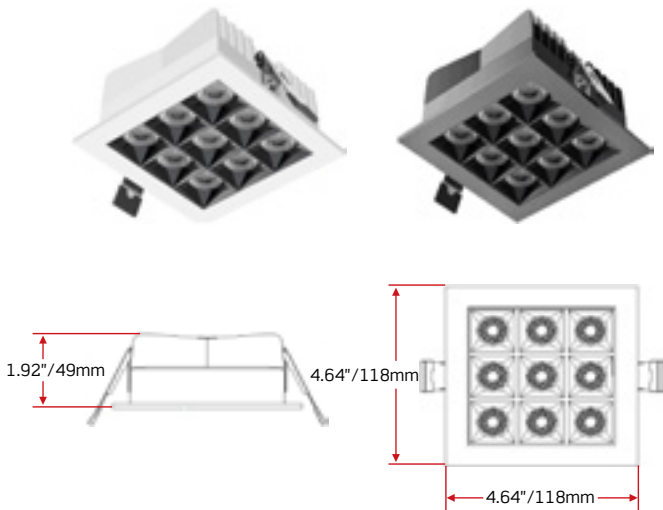

LISTING / WARRANTY

ETL listed to US and Canadian standards for damp location W/Feed through.
 3 Years Limited Warranty.

FOR ADDITIONAL ACCESSORIES SEE PAGE 134





www.beachlightingusa.com

NR5L-15W-3D90-38-GMB NR5L-15W-3D90-38-GMW MINI SPOT 5 LIGHT RECTANGULAR RECESSED LIGHT

SPECIFICATION	
Wattage	15 W
Light Output	1200LM
Optics	38°
CCT	3000K
Material	Die-Cast Aluminum
Dimming	Triac / ELV Dimmers
Finish	Matte White/Black with Gun Metal Insert
Certification	ETL / DAMP LOCATION
CR!	90 CRI

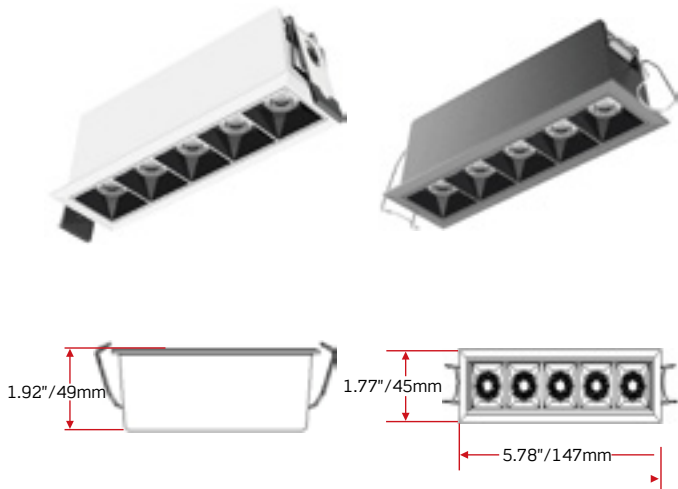

NR-MULTI-NC
New construction plate

NR10L-30W-3D90-38-GMB NR10L-30W-3D90-38-GMW MINI SPOT 10 LIGHT RECTANGULAR RECESSED LIGHT

SPECIFICATION	
Wattage	30 W
Light Output	2400LM
Optics	38°
CCT	3000K
Material	Die-Cast Aluminum
Dimming	Triac / ELV Dimmers
Finish	Matte White/Black with Gun Metal Insert
Certification	ETL / DAMP LOCATION



LISTING / WARRANTY

ETL listed to US and Canadian standards for damp location W/Feed through.
3 Years Limited Warranty.

FOR ADDITIONAL ACCESSORIES SEE PAGE 134







www.beachlightingusa.com

MR5L-10W-3D-30-MWB
MR5L-10W-4D-30-MWB
MICRO 5 LIGHT RECTANGULAR
RECESSED LIGHT

LED MICRO MULTIPLES



SPECIFICATION	
Wattage	10 W
Light Output	750lm
Optics	30°
CCT	3000K / 4000K
Material	Die-Cast Aluminum
Dimming	Triac / ELV Dimmers
Finish	Matte White/Black
Certification	ETL/ Damp location

DIMENSIONS L: 5 7/8" W: 1 8/10" H: 2"

Cut out: 5 5/8" x 1 1/2"

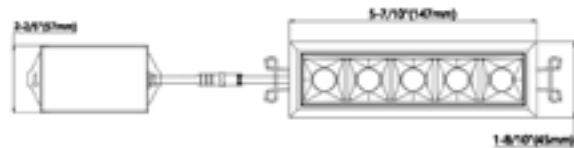

MR5-NC New Construction Plate



LISTING / WARRANTY

ETL listed to US and Canadian standards for damp location W/Feed through.
 3 Years Limited Warranty.

FOR ADDITIONAL ACCESSORIES SEE PAGE 134





www.beachlightingusa.com

MR10L-20W-3D-30-MWB
MR10L-20W-4D-30-MWB
 MICRO 10 LIGHT RECTANGULAR
 RECESSED LIGHT

MR10L-20W-4D-15-MWB
 (15 degree beam spread)

LED MICRO MULTIPLES



SPECIFICATION	
Wattage	20 W
Light Output	1500lm
Optics	15° / 30°
CCT	3000K / 4000K
Material	Die-Cast Aluminum
Dimming	Triac / ELV Dimmers
Finish	Matte White/Black
Certification	ETL / Damp location

DIMENSIONS L: 11 1/5" W: 3-5/8" (87mm) Cut out: 10 3/4" x 1 1/2"

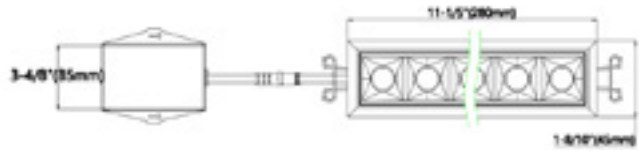
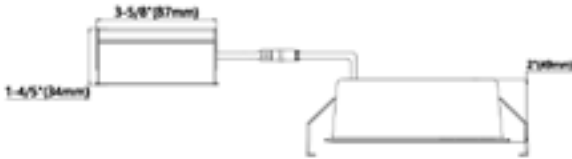

MR10-NC New Construction Plate



LISTING / WARRANTY

ETL listed to US and Canadian standards for damp location W/Feed through.
 3 Years Limited Warranty.

FOR ADDITIONAL ACCESSORIES SEE PAGE 134





www.beachlightingusa.com

MR15L-30W-3D-30-MWB

MR15L-30W-4D-30-MWB

MICRO 15 LIGHT RECTANGULAR
RECESSED LIGHT

MR15L-30W-4D-15-MWB

(15 degree beam spread)



SPECIFICATION

Wattage	30 W
Light Output	2400lm
Optics	15° / 30°
CCT	3000K / 4000K
Material	Die-Cast Aluminum
Dimming	Triac / ELV Dimmers
Finish	Matte White/Black
Certification	ETL/ Damp location

DIMENSIONS: 16 1/5" W

Cut out: 16" x 1 1/2"

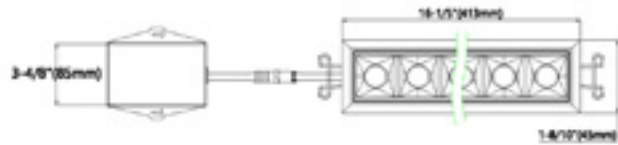
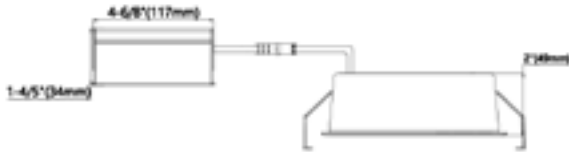

MR15-NC New Construction Plate



LISTING / WARRANTY

ETL listed to US and Canadian standards for damp location W/Feed through.
3 Years Limited Warranty.

FOR ADDITIONAL ACCESSORIES SEE PAGE 134





www.beachlightingusa.com

MR10AL-20W-3D-30-MWB
MR10AL-20W-4D-30-MWB
 MICRO 10 LIGHT ADJUSTABLE
 RECTANGULAR RECESSED LIGHT

LED MICRO MULTIPLES



SPECIFICATION

Wattage	20 W
Light Output	1500lm
Optics	30°
CCT	3000K/4000K
Material	Die-Cast Aluminum
Dimming	Triac / ELV Dimmers
Finish	Matte White/Black
Certification	ETL/ Damp Location

* Use only on 1/2" Drywall applications

DIMENSIONS: 12 3/5"

W

cut out: 11 3/5" x 3 3/5"



LISTING / WARRANTY

ETL listed to US and Canadian standards for damp location W/Feed through.
 3 Years Limited Warranty.



APPLICATION





www.beachlightingusa.com

MR15AL-30W-3D-30-MWB

MR15AL-30W-4D-30-MWB

MICRO 15 LIGHT ADJUSTABLE
RECTANGULAR RECESSED LIGHT



SPECIFICATION

Wattage	30 W
Light Output	2400lm
Optics	30°
CCT	3000/
Material	Die-Cast Aluminum
Dimming	Triac / ELV Dimmers
Finish	Matte White/Black
Certification	ETL/Damp Location

* Use only on ½ " Drywall applications

DIMENSIONS L: 17 1/2"

Cut out: 16 1/5" x 3 3/5"

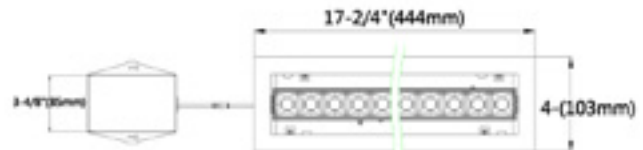

LISTING / WARRANTY

FOR ADDITIONAL ACCESSORIES SEE PAGE 134

ETL listed to US and Canadian standards for damp location W/Feed through.
3 Years Limited Warranty.



APPLICATION

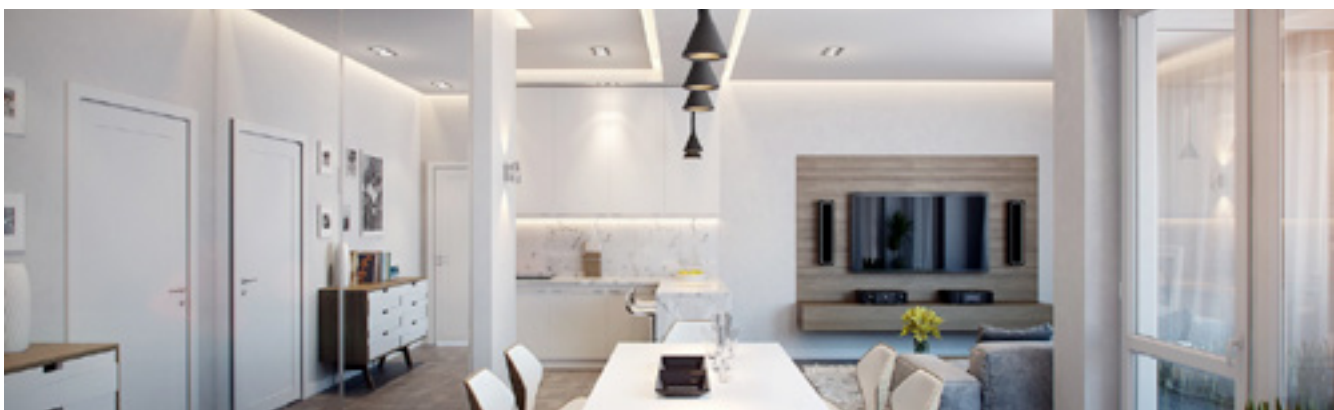



www.beachlightingusa.com

MR5-INSERT-MW

5 LIGHT COVER IN WHITE

LED MICRO MULTIPLES



**FITS ALL
MICRO SERIES
(MR- SERIES)**

LISTING / WARRANTY

ETL listed to US and Canadian standards for damp location W/Feed through.
3 Years Limited Warranty.



APPLICATION





www.beachlightingusa.com

MR10WW-20W-3D-MWB
MR10WW-20W-4D-MWB
MICRO 10 LIGHT WALL WASH
RECESSED LIGHT

LED MICRO MULTIPLES



SPECIFICATION	
Wattage	20 W
Light Output	800lm
CCT	3000/4000K
Material	Die-Cast Aluminum
Dimming	Triac / ELV Dimmers
Cut out	10" 3/4" x 1 1/2"
Size	2 1/8" L: 11"
Certification	ETL/Damp Location

DIMENSIONS L: 11" W: 2 1/8"

Cut out: 10" 3/4" x 1 1/2"



MR10-NC New Construction Plate

MR5WW-INSERT-MW
5 LIGHT COVER IN WHITE



LISTING / WARRANTY

FOR ADDITIONAL ACCESSORIES SEE PAGE 134

ETL listed to US and Canadian standards for damp location W/Feed through.
 3 Years Limited Warranty.





www.beachlightingusa.com

MR15WW-30W-3D-MWB
MR15WW-30W-4D-MWB
 MICRO 15 LIGHT WALL WASH
 RECTANGULAR RECESSED LIGHT

LED MICRO MULTIPLES



SPECIFICATION	
Wattage	30 W
Light Output	1200lm
CCT	3000/4000K
Material	Die-Cast Aluminum
Dimming	Triac / ELV Dimmers
Cut out	15" 5/8" x 1 1/2"
Size	L: 16 1/4" W: 2 1/8" H: 2 1/8"
Certification	ETL/Damp Location

DIMENSIONS L: 16 1/4" W:

Cut out: 15" 4/5" x 12/5"



MR15-NC New Construction Plate

MR5WW-INSERT-MW
 5 LIGHT COVER IN WHITE



LISTING / WARRANTY

FOR ADDITIONAL ACCESSORIES SEE PAGE 134

ETL listed to US and Canadian standards for damp location W/Feed through.
 3 Years Limited Warranty.



www.beachlightingusa.com

Mini Residential Multiples Light Up Your Home!

Residential Multiples

Beach Lighting Residential Multiple Downlight features a patent-pending mini LED spot. The high-end but economical design makes it affordable to any residential application and offers a sleek design. Available in 1, 2, and 3 lights configurations.

Standard Configurations



One-Light Two-Light Three-Light

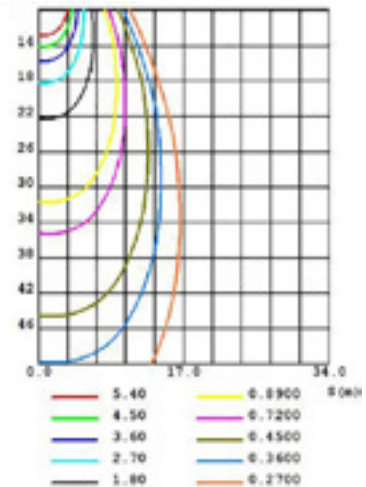
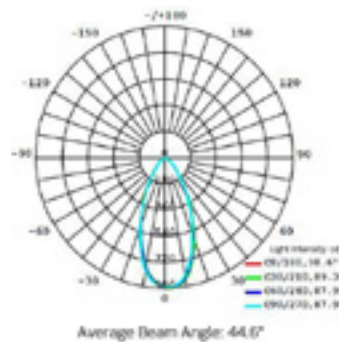

Why is the residential multiple so popular?

- Economical reasonable price
- Reduced size to save space
- 1/2/3 lights, trim/trimless, face/open trim, providing more options for your home
- High-end sleek look, better to decorate your home
- Different light sources for your choice
- Adjustable design to create more illuminating effect
- Can replace the bulbs without removing the trim



All Beach Lighting Multiples are offered with 3-Year limited warranty. A robust sleek design, state-of-the-art engineering and a rigorous testing regimen are all factors that make our products so reliable. All the recessed multiples are cETLus listed.

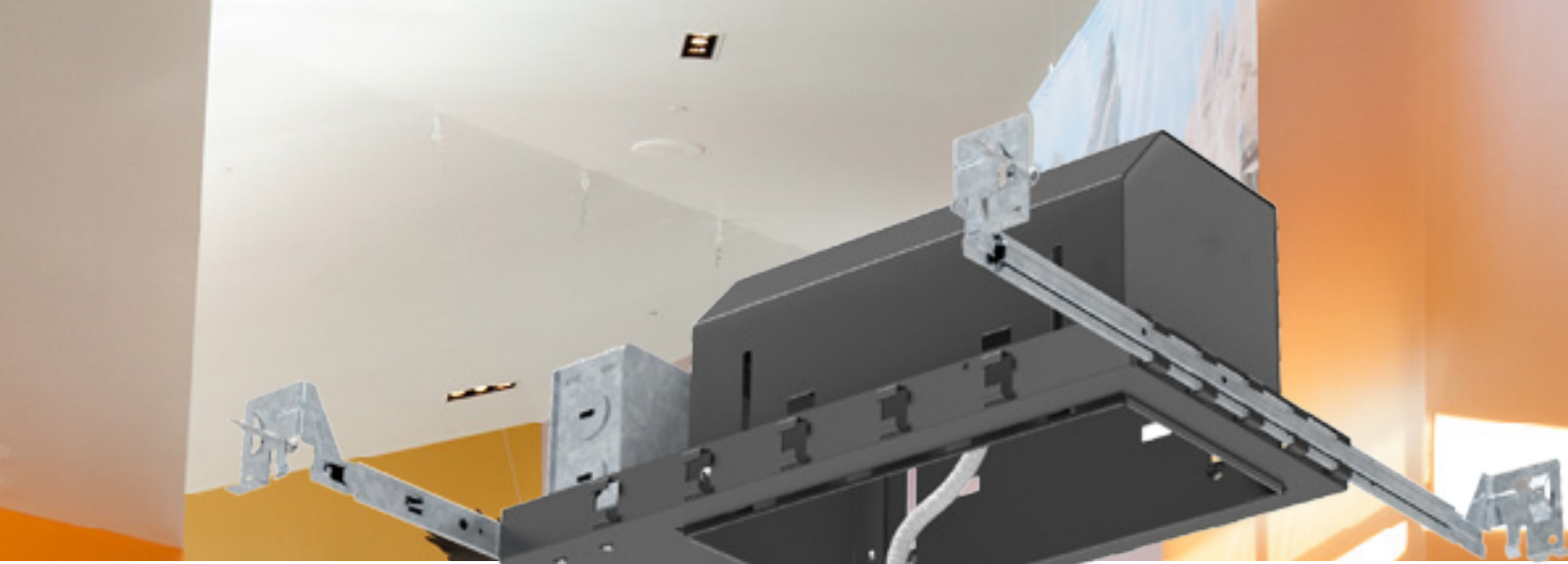

Material
 Heavy gauge cold rolled steel housing

LED Driver and Cover
 The cover separates the driver and connecting wire from the light source.
 Clip-on design cover for easy maintenance.

Mounting
 Universal clips designed for easy installation into existing ceilings

Mesh Plate(Trimless)

Thermally Efficient Heat Sink
 LED mounted to die-cast/extruded aluminum heat sink with active cooling, these heat sinks are designed to dissipate heat well below the recommended operating junction temperature.

Reflector Optic



36°

Optic Bezel
 Can change the louver to filter and the light, and avoid glare.

Ideal Quick Connector
 UL listed Ideal quick connector, invisible wire design to ensure the electrical safety



Adjustability
 30° vertical tilt

LED
 COB chips can be changed (Chip Brand, CCT, CRI...)

Lens
 Can change the lens color for different applications

MESH PLATE (TRIMLESS)

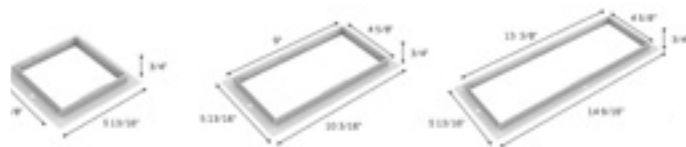

One-Light

Two-Light

Three-Light



www.beachlightingusa.com



DESCRIPTION

Mini LED Multiple Spots for remodeling and new construction applications for residential and commercial environments. The Multiple Spot housings and trims are sold as separate units. Available as one, two, and three light configurations, each spot is individually adjustable and provides a 30-degree visual cutoff for glare control.

MOUNTING

Supplied with 4 way hanger bar, adjustable from 14½"-25" to accommodate various joist construction and grid sizes. Hanger bars include a captive mounting "screw-nail" for easy installation. Can accommodate a 1/2" to 1 1/4" ceiling thickness.

FEATURES

Individually adjustable luminaries
Complete unit includes housing & trim
All housings are Non-IC rated
30° vertical tilt, 360° horizontal rotation

CONSTRUCTION

Die-cast aluminum heat sink painted black.
Trim and housing are constructed of Gauge Steel.

MOUNTING

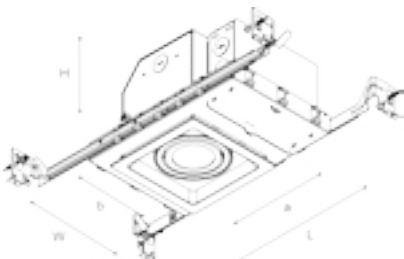

1x1 SPOTS

L: 9 1/8"
W: 6 1/4"
H: 5 1/8"

Cut-Out(axb):
4 3/4" x 4 3/4"

RESIDENTIAL NEW CONSTRUCTION LED COB MULTIPLE DOWNLIGHT

HOUSING : MH4011COB-AT

TRIMMED : MT4011COB-MW

TRIMLESS : MT4011COB-TL-MW

TWO PART SYSTEM

Must order a housing and a trim at the same time.

SPECIFICATION

Light Source	LED COB
Wattage	10W Lamp
Light Output	1000 LM
CRI	>80
CCT	3000K
Driver Input	120V AC
Power Factor	0.98
Dimming	TRIAC Dimmers 10%-100% (120V only)
Material	Gauge Steel
Finish	Matte White
Certification	ETL
Warranty	3 Year Limited for Fixture & Driver

CLOSED TRIM



Trimmed

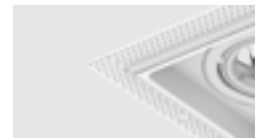

Trimless

Special closed flanged design

LISTING / WARRANTY



ETL listed to US and Canadian standards for damp location W/Feed through.
3 Years Limited Warranty.

LIGHT DISTRIBUTION CURVE

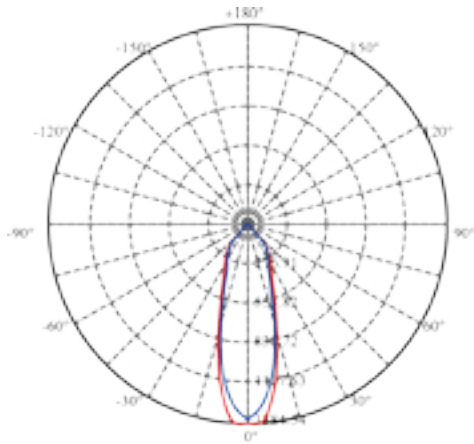

C0(Max): —
 C0/C180: —
 C90/C270: —

Field angle(10%Imax):C0/180Left:41.8 Right:41.8
 C90/270Left:41.2 Right:41.2
 Beam Angle(50%Imax) C0/180Left:17.0 Right:17.0
 C90/270Left:15.7 Right:15.7

1.0m	1384.5 , 1029.4 lx	62.06cm
2.0m	346.1 , 257.3 lx	124.11cm
3.0m	153.8 , 114.4 lx	186.17cm
4.0m	86.5 , 64.3 lx	248.22cm
5.0m	55.4 , 41.2 lx	310.28cm
6.0m	38.5 , 28.6 lx	372.33cm
7.0m	28.3 , 21.0 lx	434.39cm
8.0m	21.6 , 16.1 lx	496.44cm
9.0m	17.1 , 12.7 lx	558.50cm
10.0m	13.8 , 10.3 lx	620.55cm

Max , Ave Beam angle of C0plane 34.48

APPLICATION





www.beachlightingusa.com

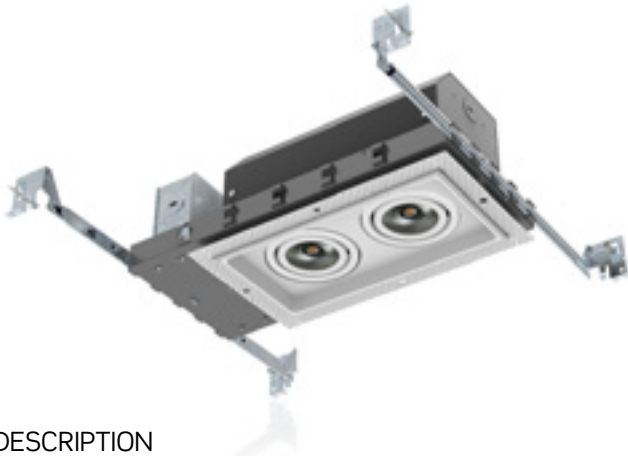

DESCRIPTION

LED Multiple Spots for remodeling and new construction applications for residential and commercial environments. The Multiple Spot housings and trims are sold as separate units. Available as one, two, and three light configurations, each spot is individually adjustable and provides a 30-degree visual cutoff for glare control.

MOUNTING

Supplied with 4 way hanger bar, adjustable from 14½"-25" to accommodate various joist construction and grid sizes. Hanger bars include a captive mounting "screw-nail" for easy installation. Can accommodate a 1/2" to 1 1/4" ceiling thickness.

FEATURES

Individually adjustable luminaries
Complete unit includes housing & trim
All housings are Non-IC rated
30° vertical tilt, 360° horizontal rotation

CONSTRUCTION

Die-cast aluminum heat sink painted black.
Trim and housing are constructed of Gauge Steel.

MOUNTING

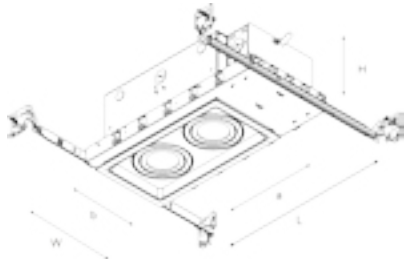

1x1 SPOTS

L: 13 3/16"
W: 6 1/4"
H: 5 1/8"

Cut-Out(axb):
8 3/4" x 4 3/8"

RESIDENTIAL NEW CONSTRUCTION LED COB MULTIPLE DOWNLIGHT

HOUSING : MH4012COB-AT

TRIMMED : MT4012COB-MW

TRIMLESS : MT4012COB-TL-MW

TWO PART SYSTEM

Must order a housing and a trim at the same time.

SPECIFICATION

Light Source	LED COB
Wattage	10W Lamp x 2
Light Output	2000 LM
CRI	>80
CCT	3000K
Driver Input	120V AC
Power Factor	0.98
Dimming	TRIAC Dimmers 10%-100% (120V only)
Material	Gauge Steel
Finish	Matte White
Certification	ETL
Warranty	3 Year Limited for Fixture & Driver

CLOSED TRIM



Trimmed

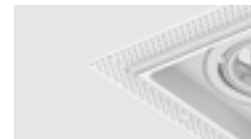

Trimless

Special closed flanged design

LISTING / WARRANTY



ETL listed to US and Canadian standards for damp location W/Feed through.
3 Years Limited Warranty.

LIGHT DISTRIBUTION CURVE

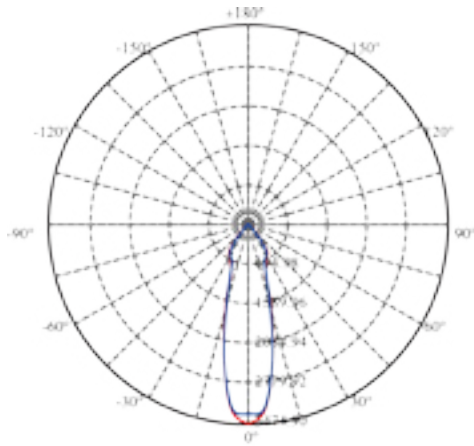

C0(Max): —
 C0/C180: —
 C90/C270: —

Field angle(10%Imax):C0/180Left:38.6 Right:38.6
 :C90/270Left:39.6 Right:39.6
 Beam Angle(50%Imax):C0/180Left:13.7 Right:13.7
 :C90/270Left:13.8 Right:13.8

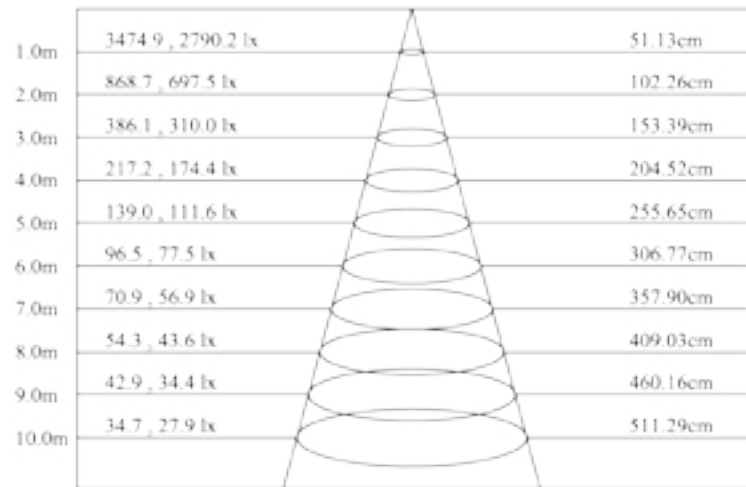

Max, Ave Beam angle of C0plane:28.68

APPLICATION





www.beachlightingusa.com



DESCRIPTION

LED Multiple Spots for remodeling and new construction applications for residential and commercial environments. The Multiple Spot housings and trims are sold as separate units. Available as one, two, and three light configurations, each spot is individually adjustable and provides a 30-degree visual cutoff for glare control.

MOUNTING

Supplied with 4 way hanger bar, adjustable from 14½"-25" to accommodate various joist construction and grid sizes. Hanger bars include a captive mounting "screw-nail" for easy installation. Can accommodate a 1/2" to 1 1/4" ceiling thickness.

FEATURES

Individually adjustable luminaries
Complete unit includes housing & trim
All housings are Non-IC rated
30° vertical tilt, 360° horizontal rotation

CONSTRUCTION

Die-cast aluminum heat sink painted black.
Trim and housing are constructed of Gauge Steel.

MOUNTING

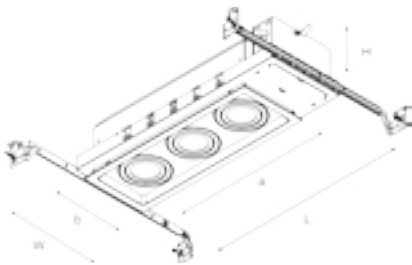

1x1 SPOTS

L: 17 5/16"
W: 6 1/4"
H: 5 1/8"

Cut-Out(axb):
13 1/4" x 4 3/8"

RESIDENTIAL NEW CONSTRUCTION LED COB MULTIPLE DOWNLIGHT

HOUSING : MH4013COB-AT

TRIMMED : MT4013COB-MW

TRIMLESS : MT4013COB-TL-MW

TWO PART SYSTEM

Must order a housing and a trim at the same time.

SPECIFICATION

Light Source	LED COB
Wattage	10W Lamp x 3
Light Output	3000 LM
CRI	>80
CCT	3000K
Driver Input	120V AC
Power Factor	0.98
Dimming	TRIAC Dimmers 10%-100% (120V only)
Material	Gauge Steel
Finish	Matte White
Certification	ETL
Warranty	3 Year Limited for Fixture & Driver

CLOSED TRIM



Trimmed



Trimless

Special closed flanged design

LISTING / WARRANTY



ETL listed to US and Canadian standards for damp location W/Feed through.
3 Years Limited Warranty.

LIGHT DISTRIBUTION CURVE

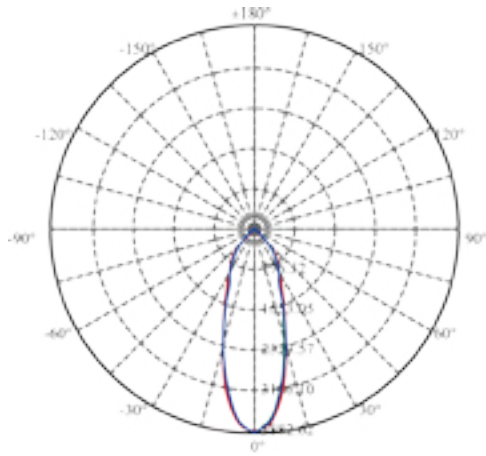

C67.5(Max):
 C0/C180:
 C90/C270:
 Field angle(10%Imax):C0/180Left:42.6 Right:42.6
 :C90/270Left:42.6 Right:42.6
 Beam Angle(50%Imax):C0/180Left:17.9 Right:17.9
 :C90/270Left:17.2 Right:17.2

1.0m	3882.6 , 2976.6 lx	65.78cm
2.0m	970.7 , 744.1 lx	131.57cm
3.0m	431.4 , 330.7 lx	197.35cm
4.0m	242.7 , 186.0 lx	263.14cm
5.0m	155.3 , 119.1 lx	328.92cm
6.0m	107.9 , 82.7 lx	394.71cm
7.0m	79.2 , 60.7 lx	460.49cm
8.0m	60.7 , 46.5 lx	526.28cm
9.0m	47.9 , 36.7 lx	592.06cm
10.0m	38.8 , 29.8 lx	657.85cm

Max , Ave Beam angle of C67.5plane36.41

LED COB MULTIPLES

APPLICATION





www.beachlightingusa.com

RESIDENTIAL REMODEL LED GU10 MULTIPLE DOWNLIGHT

HOUSING : MH4011RAT

TRIMMED : MT4011-MW



TWO PART SYSTEM

Must order a housing and a trim at the same time.
Not compatible with Trimless Trim

SPECIFICATION

Light Source	LED COB
Wattage	8W Lamp
Input	120V AC
Power Factor	0.98
Dimming	TRIAC Dimmers 10%-100% (120V only)
Material	Gauge Steel
Finish	Matte White
Certification	ETL
Warranty	3 Year Limited for Fixture & Driver

DESCRIPTION

Mini LED Multiple Spots for remodeling and new construction applications for residential and commercial environments. The Multiple Spot housings and trims are sold as separate units (trimless available). Available as one, two and three-light configurations, each spot is individually adjustable and provides a 30-degree visual cutoff for glare control.

FEATURES

Individually adjustable luminaries
Complete unit includes housing & trim
All housings are Non-IC rated
30° vertical tilt, 360° horizontal rotation

CONSTRUCTION

Die-cast aluminum heat sink painted black. Trim and housing are constructed of Gauge Steel.

MOUNTING

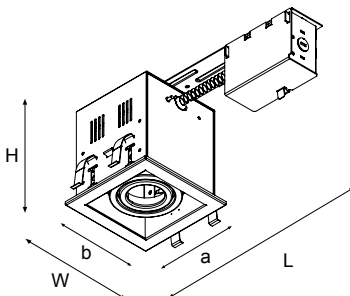

1x1 SPOTS

L: 12 3/16"

W: 5"

H: 5 1/16"

Cut-Out(axb):

4 1/4" x 4 1/4"

CLOSED TRIM



Special closed flanged design

LISTING / WARRANTY



ETL listed to US and Canadian standards for damp location W/Feed through.
3 Years Limited Warranty.



www.beachlightingusa.com

RESIDENTIAL NEW CONSTRUCTION LED GU10 MULTIPLE DOWNLIGHT

HOUSING : MH4011AT

TRIMMED : MT4011-MW

TRIMLESS : MT4011TL-MW

TWO PART SYSTEM

Must order a housing and a trim at the same time.



DESCRIPTION

Mini LED Multiple Spots for remodeling and new construction applications for residential and commercial environments. The Multiple Spot housings and trims are sold as separate units. Available as one, two, three light configurations, each spot is individually adjustable and provides a 30-degree visual cutoff for glare control.

MOUNTING

Supplied with 4 ways hanger bar, adjustable from 14½"-25" to accommodate various joist construction and grid sizes. Hanger bars include a captive mounting "screw-nail" for easy installation. Can accommodate a 1/2" to 1 1/4" ceiling thickness.

FEATURES

Individually adjustable luminaries
 Complete unit includes housing & trim
 All housings are Non-IC rated
 30° vertical tilt, 360° horizontal rotation

CONSTRUCTION

Die-cast aluminum heat sink painted black.
 Trim and housing are constructed of Gauge Steel.

MOUNTING

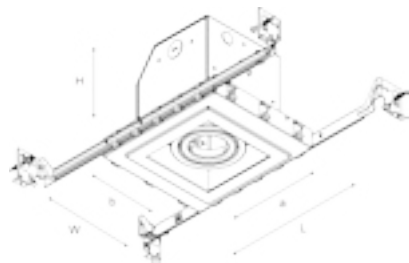

1x1 SPOTS

L: 5 7/8"

W: 6 1/4"

H: 5 1/16"

Cut-Out(axb):

4 3/4" x 4 3/4"

SPECIFICATION

Light Source	LED GU10
Wattage	8W Lamp
Input	120V AC
Power Factor	0.98
Dimming	TRIAC Dimmers 10%-100% (120V only)
Material	Gauge Steel
Finish	Matte White
Certification	ETL
Warranty	3 Year Limited for Fixture & Driver

CLOSED TRIM



Trimmed



Trimless

Special closed flanged design

LISTING / WARRANTY



ETL listed to US and Canadian standards for damp location W/Feed through.
 3 Years Limited Warranty.



www.beachlightingusa.com



DESCRIPTION

LED Multiple Spots for remodeling and new construction applications for residential and commercial environments. The Multiple Spot housings and trims are sold as separate units. Available as one, two, and three light configurations, each spot is individually adjustable and provides a 30-degree visual cutoff for glare control.

MOUNTING

Supplied with 4 way hanger bar, adjustable from 14½"-25" to accommodate various joist construction and grid sizes. Hanger bars include a captive mounting "screw-nail" for easy installation. Can accommodate a 1/2" to 1 1/4" ceiling thickness.

FEATURES

Individually adjustable luminaries
Complete unit includes housing & trim
All housings are Non-IC rated
30° vertical tilt, 360° horizontal rotation

CONSTRUCTION

Die-cast aluminum heat sink painted black.
Trim and housing are constructed of Gauge Steel.

MOUNTING

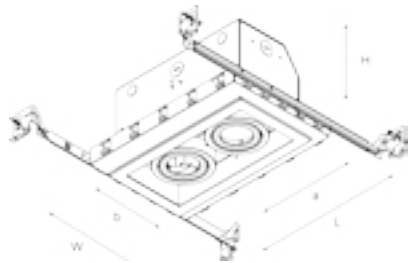

1x1 SPOTS

L: 10 9/16"
W: 6 1/4"
H: 5 1/16"

Cut-Out(axb):
8 3/4" x 4 3/8"

RESIDENTIAL NEW CONSTRUCTION LED GU10 MULTIPLE DOWNLIGHT

HOUSING : MH4012AT

TRIMMED : MT4012-MW

TRIMLESS : MT4012TL-MW

TWO PART SYSTEM

Must order a housing and a trim at the same time.

SPECIFICATION

Light Source	LED GU10
Wattage	8W Lamp x 2
Input	120V AC
Power Factor	0.98
Dimming	TRIAC Dimmers 10%-100% (120V only)
Material	Gauge Steel
Finish	Matte White
Certification	ETL
Warranty	3 Year Limited for Fixture & Driver

CLOSED TRIM



Trimmed



Trimless

Special closed flanged design

LISTING / WARRANTY



ETL listed to US and Canadian standards for damp location W/Feed through.
3 Years Limited Warranty.



www.beachlightingusa.com



DESCRIPTION

LED Multiple Spots for remodeling and new construction applications for residential and commercial environments. The Multiple Spot housings and trims are sold as separate units. Available as one, two, and three light configurations, each spot is individually adjustable and provides a 30-degree visual cutoff for glare control.

MOUNTING

Supplied with 4 way hanger bar, adjustable from 14½"-25" to accommodate various joist construction and grid sizes. Hanger bars include a captive mounting "screw-nail" for easy installation. Can accommodate a 1/2" to 1 1/4" ceiling thickness.

FEATURES

Individually adjustable luminaries
 Complete unit includes housing & trim
 All housings are Non-IC rated
 30° vertical tilt, 360° horizontal rotation

CONSTRUCTION

Die-cast aluminum heat sink painted black.
 Trim and housing are constructed of Gauge Steel.

MOUNTING

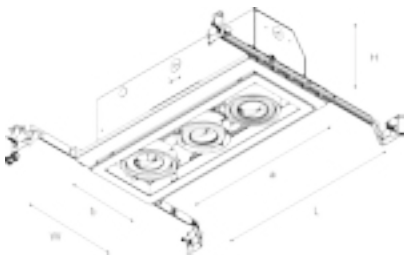

1x1 SPOTS

L: 14 1/2"
 W: 6 1/4"
 H: 5 1/16"

Cut-Out(axb):
 13 1/4" x 4 3/8"

RESIDENTIAL NEW CONSTRUCTION LED GU10 MULTIPLE DOWNLIGHT

HOUSING : MH4013AT

TRIMMED : MT4013-MW

TRIMLESS : MT4013TL-MW

TWO PART SYSTEM

Must order a housing and a trim at the same time.

SPECIFICATION

Light Source	LED GU10
Wattage	8W Lamp x 3
Input	120V AC
Power Factor	0.98
Dimming	TRIAC Dimmers 10%-100% (120V only)
Material	Gauge Steel
Finish	Matte White
Certification	ETL
Warranty	3 Year Limited for Fixture & Driver

CLOSED TRIM



Trimmed

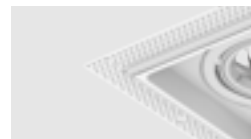

Trimless

Special closed flanged design

LISTING / WARRANTY



ETL listed to US and Canadian standards for damp location W/Feed through.
 3 Years Limited Warranty.



LED GU10 MULTIPLES

SLIM LINE RECESSED PANELS

90° Rotating Slim Series	62
4" and 6" LED panel	70
4" adjustable panel	79
Back lit panel	86
Designer LED panel	94







www.beachlightingusa.com



R3.5-NC New Construction Plate



T4R-IC-7W-3D90-MW

4" LED ROUND ADJUSTABLE PANEL

SPECIFICATION	
Wattage	7W
Light Output	500lm
CRI	>90
CCT	3000K
Rotation Angle	360°
Adjustment Angle	90°
Certification	ETL
Location	Wet Rated
Dimensions	D: 4.25" H: 1.5"
Cut Out	D: 3.5"



R3.5-NC New Construction Plate



T4S-IC-7W-3D90-MW

4" LED ROUND ADJUSTABLE PANEL

SPECIFICATION	
Wattage	7W
Light Output	500lm
CRI	>90
CCT	3000K
Rotation Angle	360°
Adjustment Angle	90°
Certification	ETL
Location	Wet Rated
Dimensions	D: 4.65" x 4.65" H: 1.50"
Cut Out	D: 3.5"

ETL listed to US and Canadian standards for wet location W/Feed through.
3 Years Limited Warranty.





www.beachlightingusa.com

T4S2-IC-12W-3D90-MW DOUBLE LED ADJUSTABLE PANEL

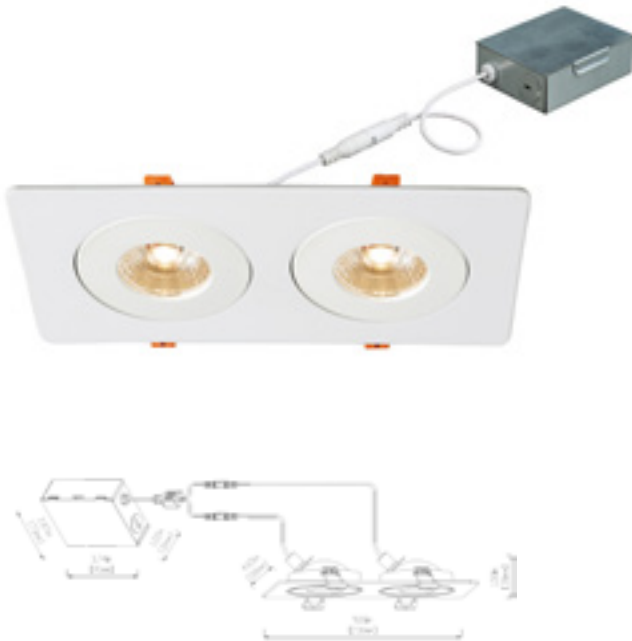

SPECIFICATION	
Wattage	12 W
Light Output	850lm
CRI	>90
CCT	3000K
Rotation Angle	360°
Adjustment Angle	90°
Certification	ETL
Location	Wet Rated
Dimensions	D: 9.06" x 4.65" H: 1.5"
Cut Out	7.8" x 3.9"

90° Rotating Slim SeriesL

T4S3-IC-15W-3D90-MW TRIPLE LED ADJUSTABLE PANEL



SPECIFICATION	
Wattage	15W
Light Output	1300lm
CRI	>90
CCT	3000K
Rotation Angle	360°
Adjustment Angle	90°
Certification	ETL
Location	Wet Rated
Dimensions	D: 13.62" x 4.65" H: 1.50"
Cut Out	71.8" x 3.9"

ETL listed to US and Canadian standards for wet location W/Feed through.
3 Years Limited Warranty.



www.beachlightingusa.com

Beach
LIGHTING

www.beachlightingusa.com



Ultra-Thin  } 1/2"



ULTRA-THIN LED RECESSED PANEL LIGHT

Beach Lighting Ultra-thin LED Recessed Panel Light Series for insulated ceilings, including the junction box and driver. The thin profile with spring clips allows for quick and easy installation. Ideal for confined spaces. The small size led panel light comes in size 4" and 6", in round or square shape.

NEW CONSTRUCTION SOLUTION FOR SLIM LINE PANELS

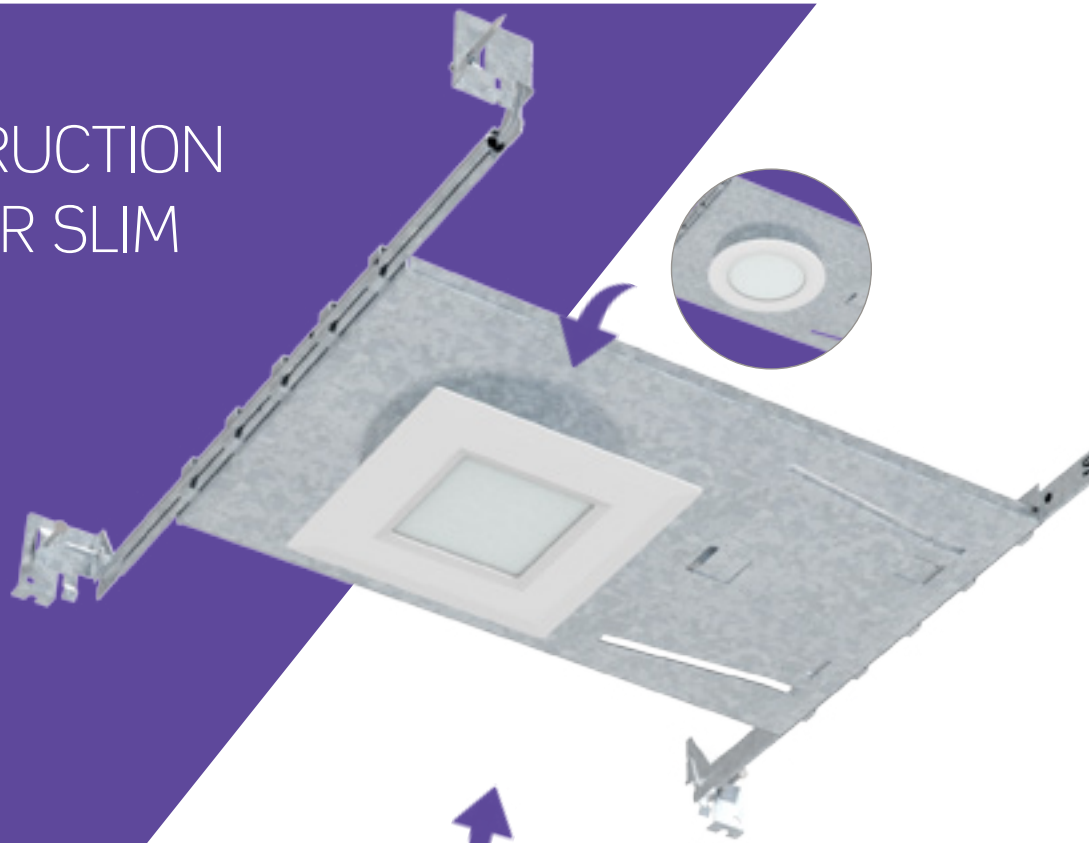

Mounting plate with square
or round aperture



Back Lit Panels round and square

Decorative Back Lit Panels



ULTRA-THIN

 } 1/2"



New Sleek Design



Back Light Leakage Prevention



Super Fast Mounting Clips



High Efficiency Driver

PARTS LIST

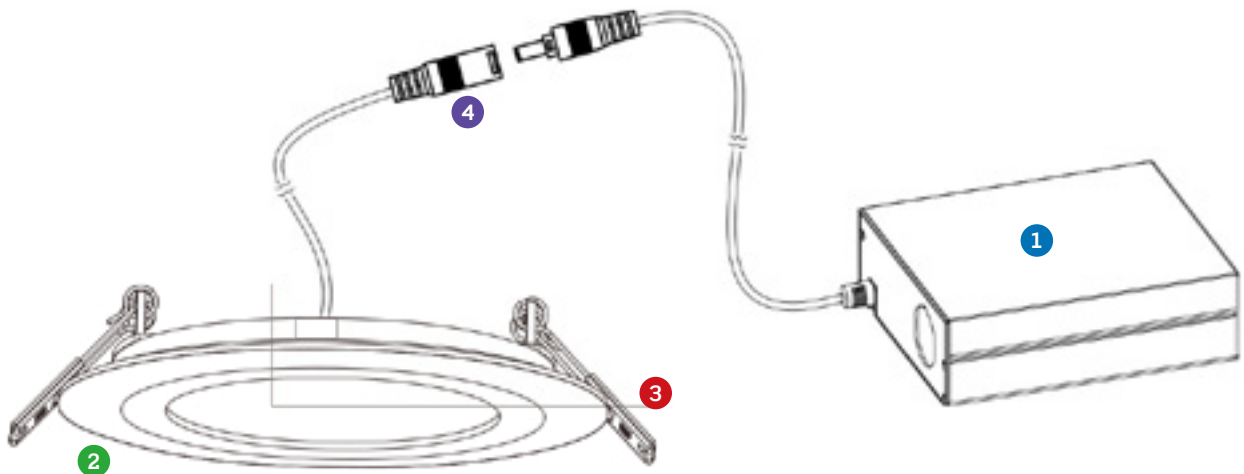

1 Junction Box & Driver

2 Light Panel

3 Spring Clips

4 Connector

ULTRA-THIN LED RECESSED PANEL LIGHT

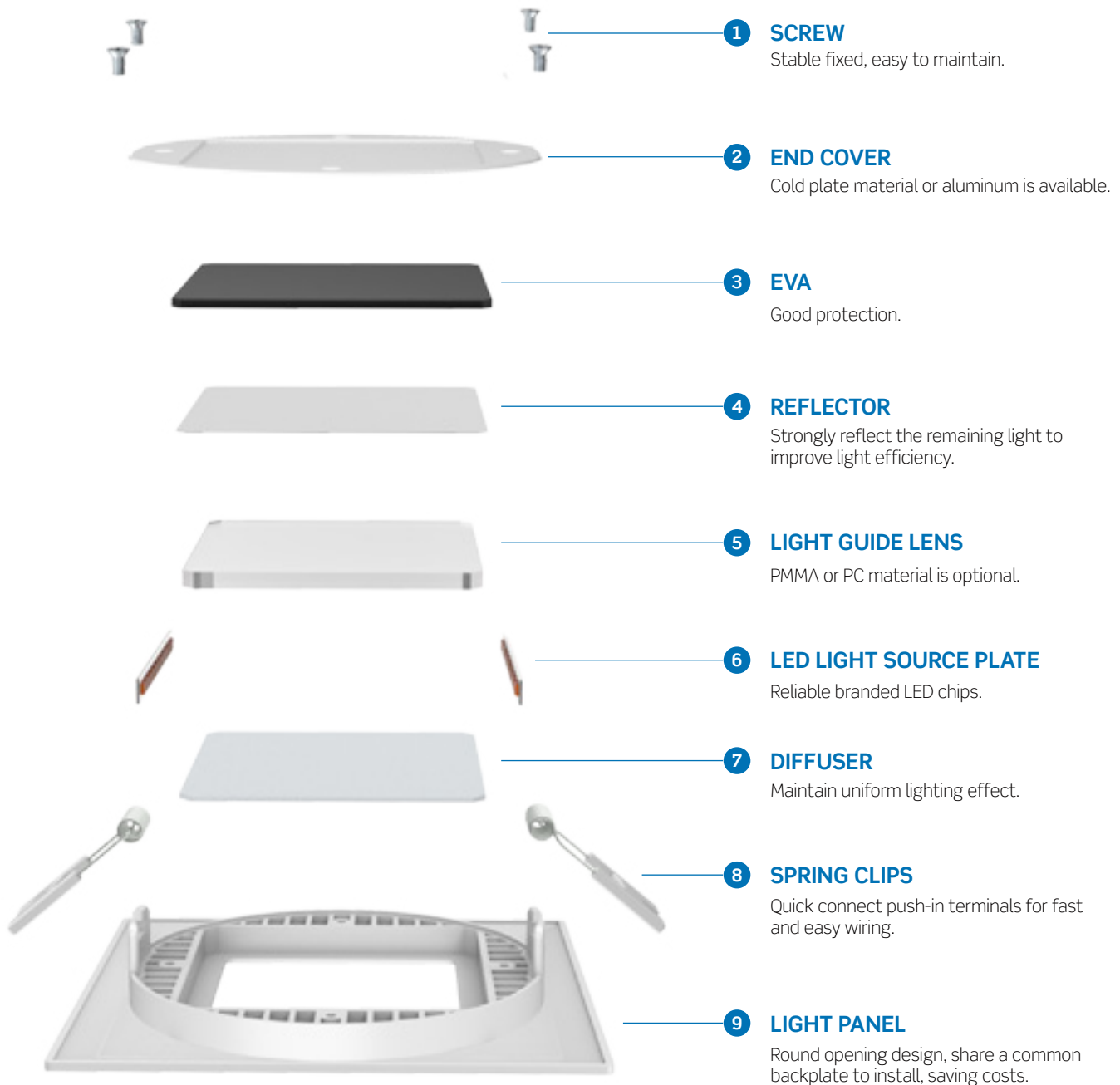

All Beach Lighting Panels are offered with 3-Year limited warranty. A robust sleek design, state-of-the-art engineering and a rigorous testing regimen are all factors that make our products so reliable. All the LED panel lights are cETLus listed.

INSTALLATION INSTRUCTIONS

Turn power OFF from the electrical panel prior to installation.

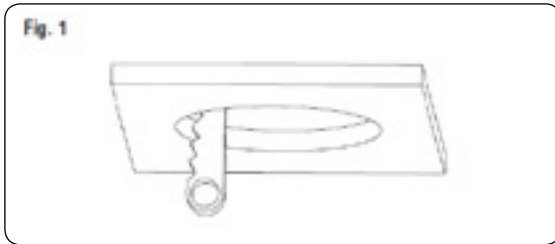

- Determine the location for installation and cut ceiling hole in accordance with cut-hole dimensions. Refer to hole diameter template for appropriate sizes.

Fig. 1

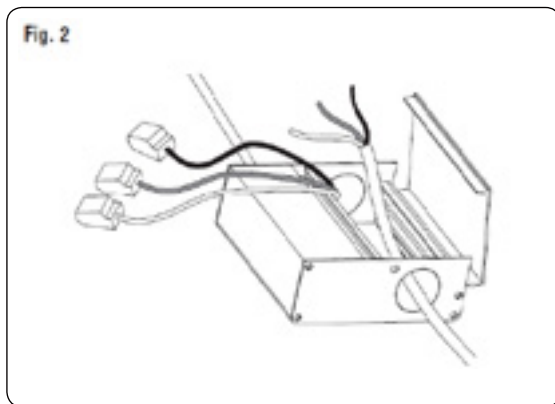

- Open the junction box cover and remove the appropriate knockout(s) on the side panel. (Fig. 2)
- Insert the electrical supply cable through the knockout and secure with a cable connector (sold separately).
- Using quick-connect push-in terminals, connect the ground wire to the green wire terminal; black wire to black wire terminal; white wire to white wire terminal.

Fig. 2

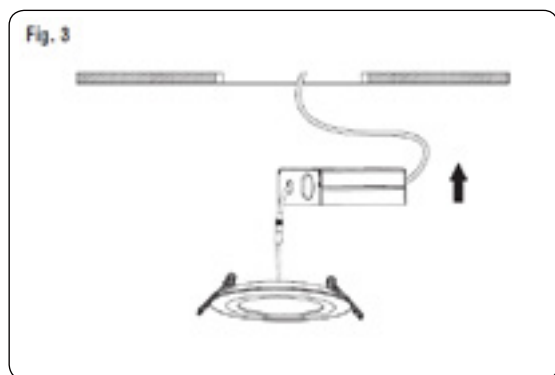

- Place all wiring and connections back in to the box and close the cover. Connect the driver to the light panel.
- Insert junction box through the mounting hole.

Fig. 3

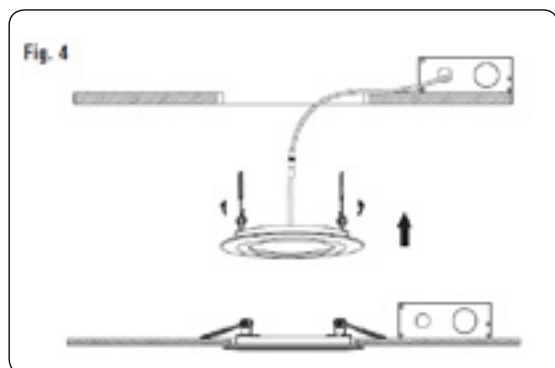

- Push spring-loaded clips on the fixture upwards and insert fixture base in to the mounting hole. Release the clips and fixture will be pulled flush to the ceiling.

Fig. 4



www.beachlightingusa.com



DESCRIPTION

This ultra thin recessed LED Panel is absolutely perfect for tight spaces, soffits and insulated dropped ceilings.

Recessed 4" Round LED Panel with integral driver in connection box. Fits where no other recessed fixture can.

This LED is 10 watts and replaces a 50 watt halogen saves up to 80% energy for same light output

The thin panel profile with spring clips allows for quick and easy installation. Ideal for confined spaces and suitable for damp locations.

FEATURES

Retrofit or new construction Install directly under joists, maximum layout flexibility.

Comes with junction box driver, no housing required.

MOUNTING

Cut hole in ceiling and snap fixture in opening with attached spring clips. 2" above ceiling clearance required for driver.

MOUNTING

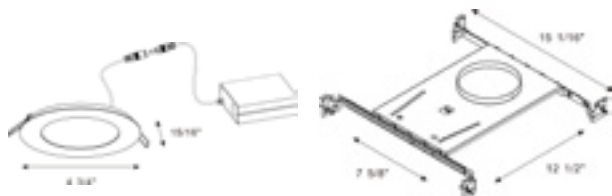

Remodel

New Construction

LISTING / WARRANTY



L4R-10W-3/4K-DW90-MW

4" ULTRA-THIN ROUND LED RECESSED PANEL LIGHT

Switch-selectable color temperature

SPECIFICATION

Applications	Recessed Ceiling Mount
Wattage	10W
Light Output	650 lm
CRI	>90
2 CCT	3000K/4000K
Driver Input	120V AC
Power Factor	0.98
Dimming	TRIAC Dimmers 10%-100% (120V only)
IC	Can Have Direct Contact With Insulation
Location	Damp Location Rated
Finish	Matte White
Certification	ETL / ENERGY STAR
Warranty	3 Year Limited for Fixture & Driver
Cut Out	D: 4 3/8"

R4-NC New Construction Plate



ETL listed to US and Canadian standards for damp location W/Feed through.
ENERGY STAR
3 Years Limited Warranty.

LIGHT DISTRIBUTION CURVE

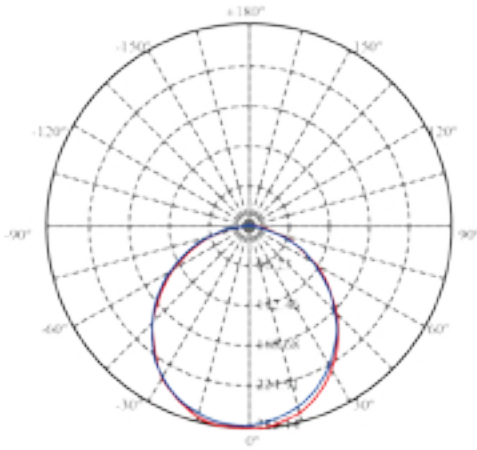

C0/C180: —
 C90/C270: —
 Field angle(10%Imax):C0/180Left:81.5 Right:78.4
 C90/270Left:81.6 Right:77.6
 Beam Angle(50%Imax):C0/180Left:56.0 Right:52.3
 C90/270Left:57.1 Right:51.9

1.0m	281.1 , 225.9 lx	277.90cm
2.0m	70.3 , 56.5 lx	555.81cm
3.0m	31.2 , 25.1 lx	833.71cm
4.0m	17.6 , 14.1 lx	1111.62cm
5.0m	11.2 , 9.0 lx	1389.52cm
6.0m	7.8 , 6.3 lx	1667.43cm
7.0m	5.7 , 4.6 lx	1945.33cm
8.0m	4.4 , 3.5 lx	2223.24cm
9.0m	3.5 , 2.8 lx	2501.14cm
10.0m	2.8 , 2.3 lx	2779.05cm

Max , Ave Beam angle of C0plane:108.36

APPLICATION





www.beachlightingusa.com



DESCRIPTION

This ultra thin recessed LED Panel is absolutely perfect for tight spaces, soffits and insulated dropped ceilings.

Recessed 4" Square LED Panel with integral driver in connection box, Fits where no other recessed fixture can.

This LED is 10 watts and replaces a 50 watt halogen. saves up to 80% energy for same light output

The thin panel profile with spring clips allows for quick and easy installation. Ideal for confined spaces and suitable for damp locations.

FEATURES

Retrofit or new construction Install directly under joists, maximum layout flexibility.

Comes with junction box driver, no housing required.

MOUNTING

Cut hole in ceiling and snap fixture in opening with attached spring clips. 2" above ceiling clearance required for driver.

MOUNTING

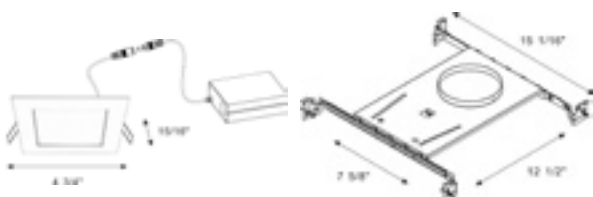

Remodel

New Construction

L4S-10W-3/4K-DW90-MW

4" ULTRA-THIN SQUARE
LED RECESSED PANEL LIGHT

Switch-selectable color temperature

SPECIFICATION

Applications	Recessed Ceiling Mount
Wattage	10W
Light Output	600 Lm
CRI	>90
2 CCT	3000K/4000K
Driver Input	120V AC
Power Factor	0.98
Dimming	TRIAC Dimmers 10%-100% (120V only)
IC	Can Have Direct Contact With Insulation
Location	Damp Location Rated
Finish	Matte White
Certification	ETL / ENERGY STAR
Warranty	3 Year Limited for Fixture & Driver
CUT OUT	D: 4 3/8"

R4-NC New Construction Plate



LISTING / WARRANTY



ETL listed to US and Canadian standards for damp location W/Feed through.
ENERGY STAR
3 Years Limited Warranty.

LIGHT DISTRIBUTION CURVE

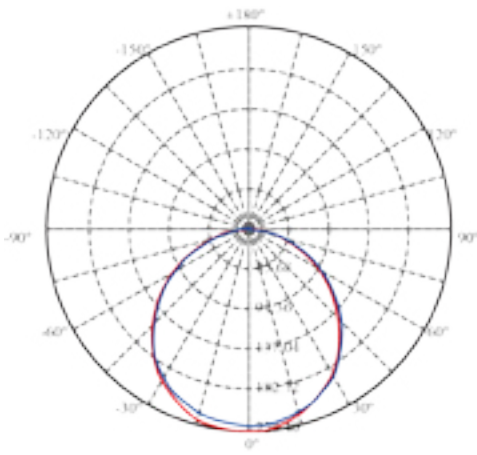

C0/C180: —
 C90/C270: —
 Field angle(10%Imax) C0/180Left:81.0 Right:78.8
 C90/270Left:80.0 Right:80.3
 Beam Angle(50%Imax) C0/180Left:56.2 Right:53.3
 C90/270Left:55.9 Right:55.5

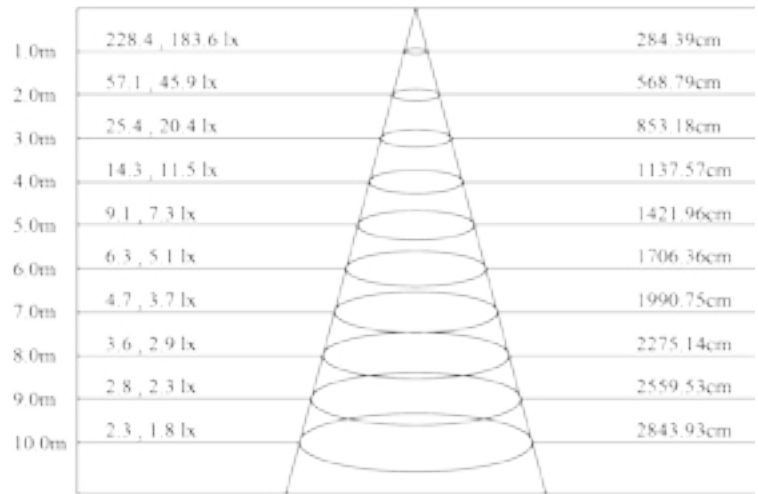

Max , Ave Beam angle of C0plane 109.66

1.0m	228.4 , 183.6 lx	284.39cm
2.0m	57.1 , 45.9 lx	568.79cm
3.0m	25.4 , 20.4 lx	853.18cm
4.0m	14.3 , 11.5 lx	1137.57cm
5.0m	9.1 , 7.3 lx	1421.96cm
6.0m	6.3 , 5.1 lx	1706.36cm
7.0m	4.7 , 3.7 lx	1990.75cm
8.0m	3.6 , 2.9 lx	2275.14cm
9.0m	2.8 , 2.3 lx	2559.53cm
10.0m	2.3 , 1.8 lx	2843.93cm

APPLICATION





www.beachlightingusa.com



DESCRIPTION

This ultra thin recessed LED Panel is absolutely perfect for tight spaces, soffits and insulated dropped ceilings.

Recessed 6" round LED Panel with integral driver in connection box, Fits where no other recessed fixture can.

This LED is 12 watts and replaces a 65 watt halogen saves up to 80% energy for same light output

The thin panel profile with spring clips allows for quick and easy installation. Ideal for confined spaces and suitable for damp locations.

FEATURES

Retrofit or new construction install directly under joists, maximum layout flexibility.

Comes with junction box driver, no housing required.

MOUNTING

Cut hole in ceiling and snap fixture in opening with attached spring clips. 2" above ceiling clearance required for driver.

MOUNTING

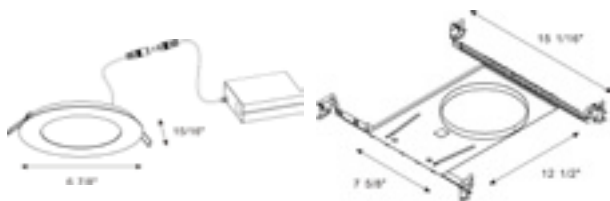

Remodel

New Construction

R2.5-4-6NC New Construction Plate



L6R-15W-3/4K-DW90-MW 6" ULTRA-THIN ROUND LED RECESSED PANEL LIGHT

Switch-selectable color temperature

SPECIFICATION

Applications	Recessed Ceiling Mount
Wattage	15W
Light Output	800 lm
CRI	>90
2 CCT	3000K/4000K
Driver Input	120V AC
Power Factor	0.98
Dimming	TRIAC Dimmers 10%-100% (120V only)
IC	Can Have Direct Contact With Insulation
Location	Damp Location Rated
Finish	Matte White
Certification	ETL / ENERGY STAR
Warranty	3 Year Limited for Fixture & Driver
CUT OUT	D: 6 1/4"

LISTING / WARRANTY



ETL listed to US and Canadian standards for damp location W/Feed through.
ENERGY STAR
3 Years Limited Warranty.

LIGHT DISTRIBUTION CURVE

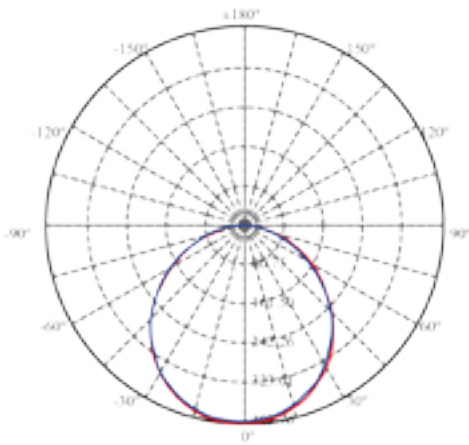

C0:C180: —
 C90:C270: —
 Field angle(10%lmax):C0/180Left:81.0 Right:79.0
 C90/270Left:81.7 Right:78.4
 Beam Angle(50%lmax):C0/180Left:55.5 Right:52.8
 C90/270Left:56.2 Right:52.4

1.0m	403.8 , 325.9 lx	278.62cm
2.0m	100.9 , 81.5 lx	557.24cm
3.0m	44.9 , 36.2 lx	835.86cm
4.0m	25.2 , 20.4 lx	1114.48cm
5.0m	16.2 , 13.0 lx	1393.10cm
6.0m	11.2 , 9.1 lx	1671.72cm
7.0m	8.2 , 6.7 lx	1950.33cm
8.0m	6.3 , 5.1 lx	2228.95cm
9.0m	5.0 , 4.0 lx	2507.57cm
10.0m	4.0 , 3.3 lx	2786.19cm

Max , Ave Beam angle of C0plane:108.57

APPLICATION





www.beachlightingusa.com



DESCRIPTION

This ultra thin recessed LED Panel is absolutely perfect for tight spaces, soffits and insulated dropped ceilings.

Recessed 6" Square LED Panel with integral driver in connection box, Fits where no other recessed fixture can.

This LED is 12 watts and replaces a 65 watt halogen saves up to 80% energy for same light output.

The thin panel profile with spring clips allows for quick and easy installation. Ideal for confined spaces and suitable for damp locations.

FEATURES

Retrofit or new construction Install directly under joists, maximum layout flexibility.

Comes with junction box driver, no housing required

MOUNTING

Cut hole in ceiling and snap fixture in opening with attached spring clips. 2" above ceiling clearance required for driver.

MOUNTING

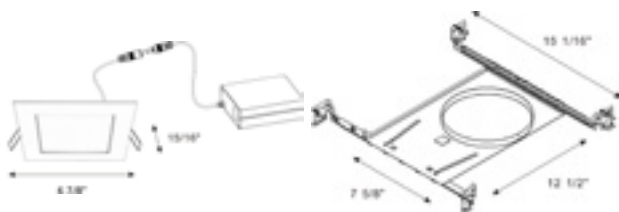

Remodel

New Construction

L6S-15W-3/4K-DW90-MW

6" ULTRA-THIN SQUARE LED RECESSED PANEL LIGHT

Switch-selectable color temperature

SPECIFICATION

Applications	Recessed Ceiling Mount
Wattage	15W
Light Output	750 lm
CRI	>90
2 CCT	3000K/4000K
Driver Input	120V AC
Power Factor	0.98
Dimming	TRIAC Dimmers 10%-100% (120V only)
IC	Can Have Direct Contact With Insulation
Location	Damp Location Rated
Finish	Matte White
Certification	ETL / ENERGY STAR
Warranty	3 Year Limited for Fixture & Driver
CUT OUT	D: 6 1/4"

R2.5-4-6-NC

New Construction Plate



LISTING / WARRANTY



ETL listed to US and Canadian standards for damp location W/Feed through.
ENERGY STAR
3 Years Limited Warranty.

LIGHT DISTRIBUTION CURVE

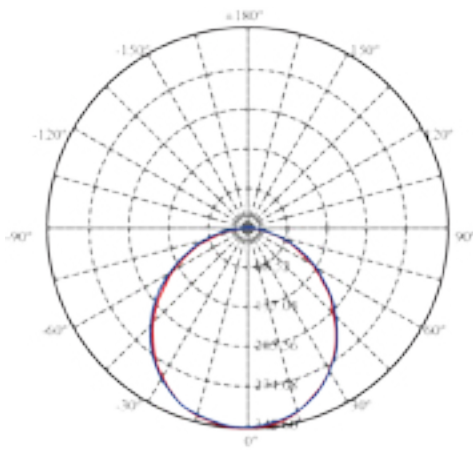

C0/C180
 C90/C270
 Field angle(10%Imax) C0/180Left:81.3 Right:78.4
 C90/270Left:82.2 Right:78.8
 Beam Angle(50%Imax) C0/180Left:55.5 Right:51.9
 C90/270Left:57.3 Right:53.2

1.0m	342.6 , 278.0 lx	274.34cm
2.0m	85.7 , 69.5 lx	548.68cm
3.0m	38.1 , 30.9 lx	823.02cm
4.0m	21.4 , 17.4 lx	1097.36cm
5.0m	13.7 , 11.1 lx	1371.70cm
6.0m	9.5 , 7.7 lx	1646.04cm
7.0m	7.0 , 5.7 lx	1920.38cm
8.0m	5.4 , 4.3 lx	2194.72cm
9.0m	4.2 , 3.4 lx	2469.06cm
10.0m	3.4 , 2.8 lx	2743.41cm

Max , Ave Beam angle of Coplane 107.67

APPLICATION





www.beachlightingusa.com

L4RO-10W-3D-MW

L4RO-10W-5D-MW

4 INCH LED DIMMABLE PANEL



R4-NC

New Construction Plate



SPECIFICATION

Applications	Recessed Ceiling Mount
Wattage	10W
Light Output	750lm
CRI	>80
2 CCT	3000K or 5000k
Driver Input	120V AC
Power Factor	0.98
Dimming	TRIAC Dimmers 10%-100% (120V only)
IC	Can Have Direct Contact With Insulation
Location	Wet Location Rated
Certification	ETL / ENERGY STAR
Warranty	3 Year Limited for Fixture & Driver
CUT OUT	D: 4 1/4"

DESCRIPTION

IC can have direct contact with insulation
 New construction plates available
 Dimmable Triac/ ELV dimmers
 Wet location
 Low profile height 2 1/4"

LISTING / WARRANTY



ETL listed to US and Canadian standards for damp location W/Feed through.
 ENERGY STAR
 3 Years Limited Warranty.



www.beachlightingusa.com

L4SSG-12W-3/4K-D90-MW
L6SSG-15W-3/4K-D90-MW
6" VERSION

Switch-selectable color temperature

LED ADJUSTABLE PANEL



DESCRIPTION

Beach Lighting Interior Dome Lights are designed to reduce glare and improve the light quality. Achieves soft lighting without seeing the source. Lights are available with LED Lighting technology and offer a stylish sleek appearance.

FEATURES

Achieve soft lighting without seeing the light source.
 No glare or light distortion.
 Die cast aluminum body material with good heat dissipation
 Higher reflection rate reflector with nano powder sprayed on surface
 Use FT 4 wire with high flame retardant grade Independent drive junction box, easy to replace
 Can be installed in 0.5 "to 1.25" thick ceilings has a safe isolated power supply Flicker free stable dimming, can be compatible with multi brand dimmers

SPECIFICATION

Applications	Recessed Ceiling Mount
Wattage	12W
Light Output	700lm
CRI	>90
CCT	3000K / 4000k
Driver Input	120V AC
Non-IC	3" Clearance On All Sides From Insulation Required
Dimming	Dimmable Triac / ELV Dimmers
Finish	Matte White
Location	Damp Locations
Certification	ETL / ENERGY STAR
Cut Out	D: 4 1/8"
Dimensions	D: 4 6/8" x 4 6/8"

MOUNTING

ETL listed to US and Canadian standards for damp location W/Feed through. 3 Years Limited Warranty.

Low profile Height: 1 11/32"

R2.5-4-6-NC New Construction Plate

SPECIFICATIONS FOR 6" VERSION

Wattage 15w
 Light Output 750 LM
 CCT 3000k-4000k
 Cut out: 6 1/8"
 Dimensions: 6 6/8" x 6 6/8"
 Location: Damp/ Non-IC

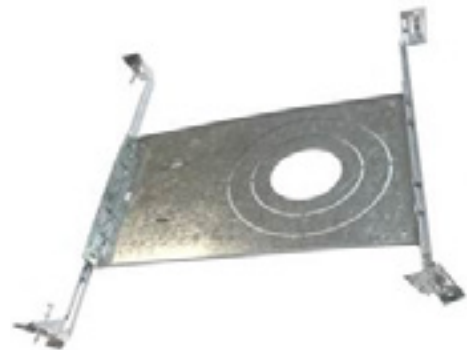

LISTING / WARRANTY

FOR ADDITIONAL ACCESSORIES SEE PAGE 134



ETL listed to US and Canadian standards for damp location W/Feed through. ENERGY STAR 3 Years Limited Warranty.





www.beachlightingusa.com



CUSTOMIZABLE TRIM



RF4-TRIM-MBK



RF4-TRIM-SVL



RF4-TRIM-BZ

FEATURES

Body: Durable airtight aluminum body with mounting holes and butterfly clips. On-face magnets allows for securely attaching one of four dead front magnetic faceplates (White, Black, Bronze and Silver)

Mounting: Can be mounted to a compatible 4" recessed housing via included butterfly clips, or attached to an industry standard 4" octagon box with minimum depth of 1.5" (40mm) via mounting holes.

LED Characteristics: This general application light fixture features an 8 watt LED module that maintains uniform intensity producing up to 500 lumens; With a typical CRI of 90. Available in 3000K temperature.

Dimming: 100%-10% dimming capability. This fixture is compatible with industry standard forward/reverse phase dimmers, TRIAC/ELV dimmers.

Beam Spread: The fixture lens provides 110° beam spread.

LED Driver: Built-in on board driver with SOMA output and 100-135V AC input.

Operating Temperature: -30 C -40 c (22°F-104°F)

Environment: Suitable for wet locations.

Fire-rated when used in a fire-rated octagon box.

LISTING / WARRANTY



RF4-8W-3D-MW

4" 8W MULTIPLE APPLICATION RECESSED DOWNLIGHT

SPECIFICATION

Applications	Ceiling Recessed Mount
Approved Location	Wet
Wattage	8W
Beam Angle	110°
CCT	3000K
Certification	cETLus
Class II	Yes
Colour	Matte White/Black/Silver/Bronze
CRI	90
Dimmable	Yes
DimmQ Tech	TRIAC/ELV
Input	AC120V 50/60HZ
LM79	Yes
LMBO	Yes
Lumens	500
Lumens per Watt	62.5
Power Factor	>0.9
Projected Life	70% @ 50,000 hrs
Warranty	3 years

DESCRIPTION

The Beach Lighting 4" 8W round down light LED light fixture is designed to be used either in a housing or in a 4" octagon box. This high performance luminaire offers solution with good light output, a variety of trims, energy-efficiency and streamlined design. Suitable for wet locations.

ETL listed to US and Canadian standards for damp location W/Feed through.
ENERGY STAR
3 Years Limited Warranty.

MOUNTING



Wings and adaptor included for retrofit installations

LIGHT DISTRIBUTION CURVE

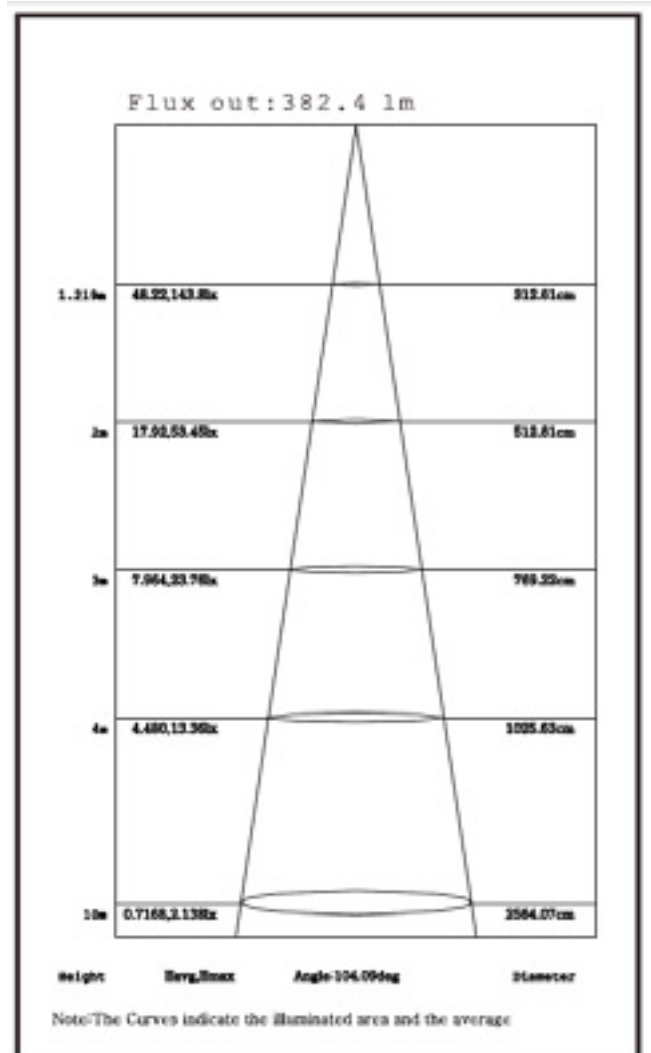
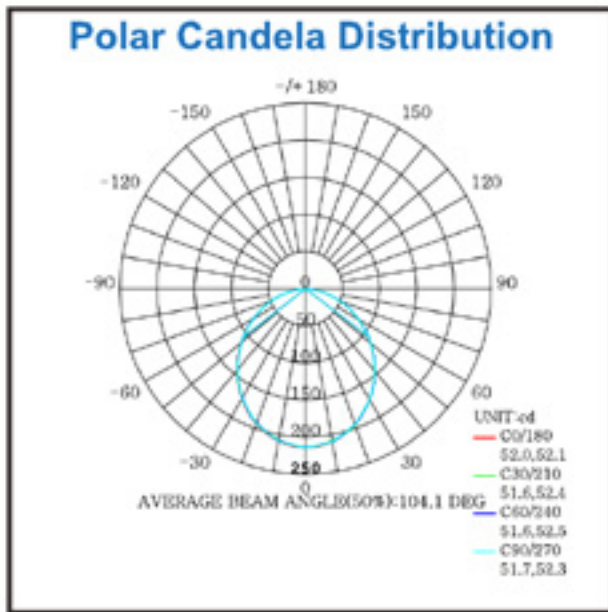



www.beachlightingusa.com



MOTION SENSOR

Turns on when detecting movement both in daytime and nighttime.
Turns off after 30 seconds.

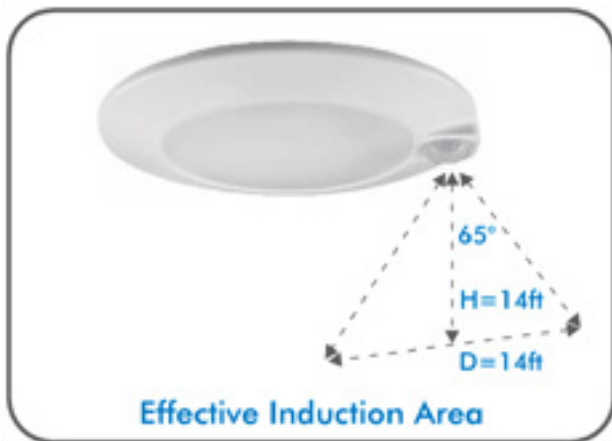

F4-10W-3K-MS-MW

F4-10W-4K-MS-MW

4" 10W LED SPACELITE

Lights turn on automatically when motion is detected,
turns off after 30 seconds when no motion is detected.

SPECIFICATION

Applications	Ceiling Surface Mount
Approved Location	Damp/Wet
Wattage	10W
Beam Angle	120°
CCT	3000K/4000k
Certification	cETLus
Class II	Yes
Colour	Matte White
CRI	90
Dimming	No
Input	AC120V 50/60HZ
LM79	Yes
LMBO	Yes
Lumens	600
Lumens per Watt	60
Power Factor	>0.9
Projected Life	70% @ 50,000 hrs
Warranty	3 years

MOUNTING

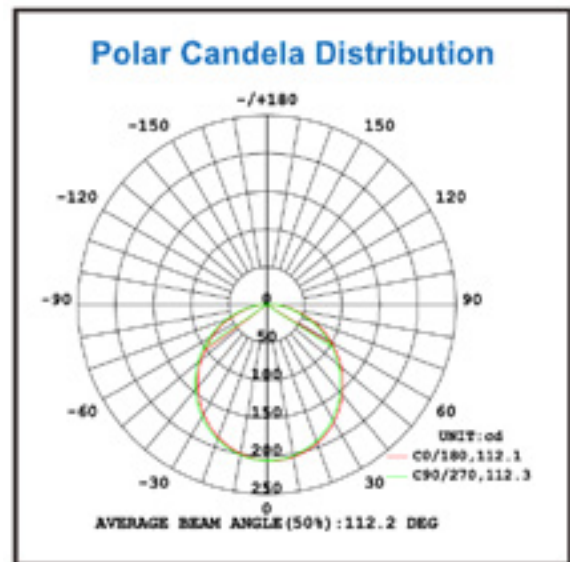

LISTING / WARRANTY



ETL listed to US and Canadian standards for damp location W/Feed through.
ENERGY STAR
3 Years Limited Warranty.



www.beachlightingusa.com



MOTION SENSOR

Turns on when detecting movement both in daytime and nighttime. Turns off after 30 seconds.

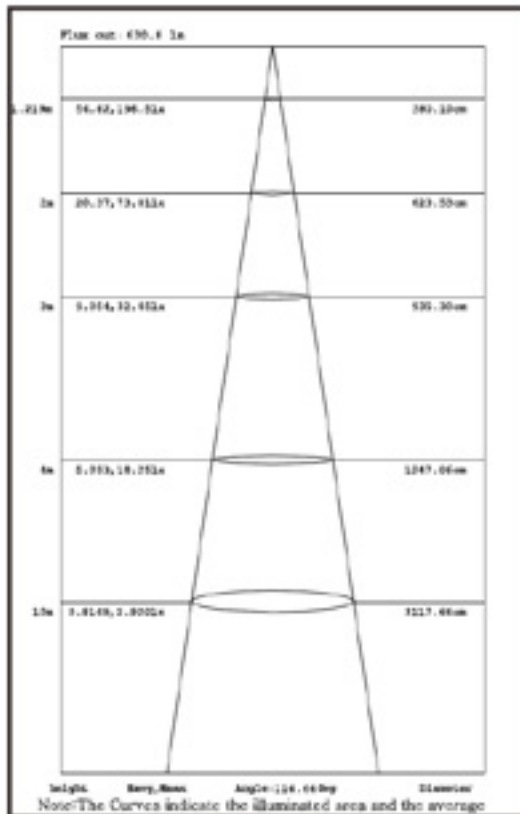

F6-15W-3K-MS-MW F6-15W-4K-MS-MW

6" 15W LED SPACELITE

Lights turn on automatically when motion is detected, turns off after 30 seconds when no motion is detected.

SPECIFICATION

Applications	Ceiling Surface Mount
Approved Location	Damp/Wet
Wattage	15W
Beam Angle	120°
CCT	3000K/4000k
Certification	cETLus
Class II	Yes
Colour	Matte White
CRI	90
Dimming	No
Input	AC120V 50/60HZ
LM79	Yes
LMBO	Yes
Lumens	950
Lumens per Watt	63.3
Power Factor	>0.9
Projected Life	70% @ 50,000 hrs
Warranty	3 years

MOUNTING

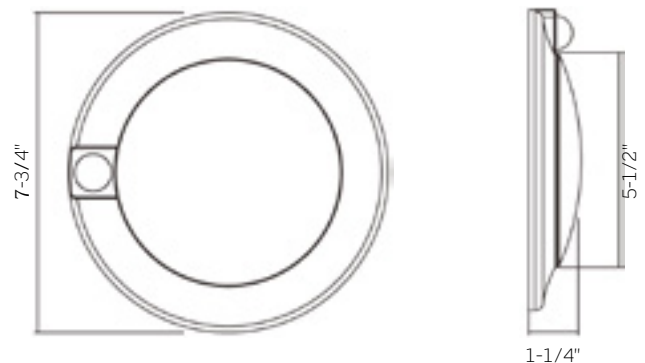

LISTING / WARRANTY



ETL listed to US and Canadian standards for damp location W/Feed through.
ENERGY STAR
3 Years Limited Warranty.



4" | 6"
ROUND | SQUARE



LED back lit panel

Beach Lighting LED Dome Light Series is designed to reduce glare and improve quality of light. Gentle light comes out to achieve soft lighting without seeing the light source, avoiding glare issues and delivering a well dispersed illumination.



www.beachlightingusa.com



DESCRIPTION

Beach Lighting Interior Dome Lights are designed to reduce glare and improve the light quality.

Achieves soft lighting without seeing the source.

Lights are available with LED Lighting technology and offer a stylish sleek appearance.

FEATURES

Achieve soft lighting without seeing the light source.

No glare or light distortion.

Die cast aluminum body material with good heat dissipation

Higher reflection rate reflector with nano powder sprayed on surface

Use FT4 wire with high flame retardant grade independent drive junction box, easy to replace

Can be installed in 0.5" to 1.25" thick ceilings safe isolated power supply

Flicker free stable dimming, can be compatible with multi brand dimmers

MOUNTING

ETL listed to US and Canadian standards for damp location W/Feed through.

3 Years Limited Warranty.

MOUNTING

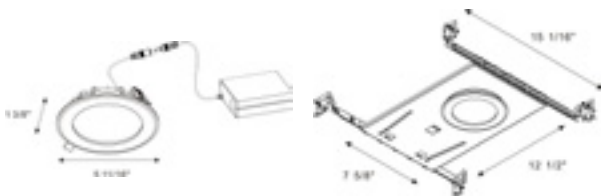

Remodel

New Construction

L4BLR-10W-3/4K-D90-MW

4" ROUND RECESSED LED DOME LIGHT

Switch-selectable color temperature

SPECIFICATION

Applications	Recessed Ceiling Mount
Wattage	10W
Light Output	730lm
CRI	>90
2 CCT	3000K/4000K
Driver Input	120V AC
Power Factor	0.98
Dimming	TRIAC Dimmers 10%-100% (120V only)
Location	Insulated Ceiling
Finish	Matte White
Certification	ETL / ENERGY STAR
Warranty	3 Year Limited for Fixture & Driver
Cut out	D: 4 1/8"
Dimensions	D: 5

R3.5-NC New Construction Plate



LISTING / WARRANTY



ETL listed to US and Canadian standards for damp location W/Feed through.

ENERGY STAR

3 Years Limited Warranty.

LIGHT DISTRIBUTION CURVE

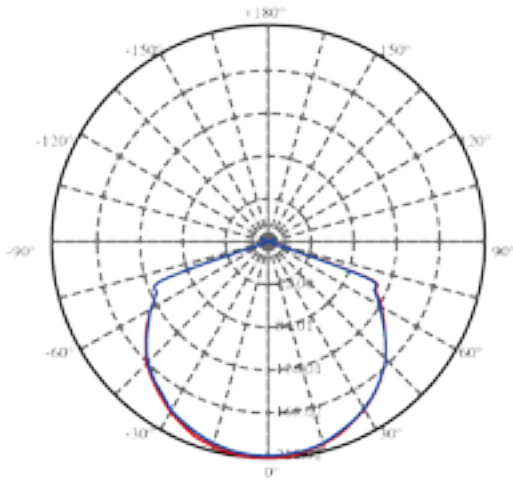

C0/C180: —
 C90/C270: —
 Field angle(10%Imax) C0/180Left:74.0 Right:74.0
 C90/270Left:74.0 Right:74.0
 Beam Angle(50%Imax) C0/180Left:70.1 Right:69.0
 C90/270Left:70.2 Right:69.1

1.0m	210.0 , 170.1 lx	536.74cm
2.0m	52.5 , 42.5 lx	1073.48cm
3.0m	23.3 , 18.9 lx	1610.22cm
4.0m	13.1 , 10.6 lx	2146.96cm
5.0m	8.4 , 6.8 lx	2683.70cm
6.0m	5.8 , 4.7 lx	3220.44cm
7.0m	4.3 , 3.5 lx	3757.18cm
8.0m	3.3 , 2.7 lx	4293.92cm
9.0m	2.6 , 2.1 lx	4830.66cm
10.0m	2.1 , 1.7 lx	5367.40cm

Max , Ave Beam angle of C0plane139.10

OPTION



R-277V PS

- 277 V Power supply
- Non-Dimmable

APPLICATION





www.beachlightingusa.com



DESCRIPTION

Beach Lighting Interior Dome Lights are designed to reduce glare and improve the light quality. Achieves soft lighting without seeing the source. Lights are available with LED Lighting technology and offer a stylish sleek appearance.

FEATURES

Achieve soft lighting without seeing the light source.
No glare or light distortion.
Die cast aluminum body material with good heat dissipation
Higher reflection rate reflector with nano powder sprayed on surface
Use FT4 wire with high flame retardant grade Independent drive junction box, easy to replace
Can be installed in 0.5" to 1.25" thick ceilings safe isolated power supply
Flicker free stable dimming, can be compatible with multi brand dimmers

MOUNTING

ETL listed to US and Canadian standards for damp location W/Feed through.
3 Years Limited Warranty.

MOUNTING

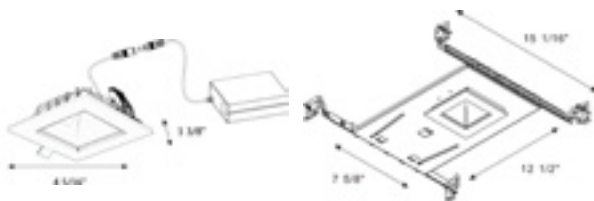

Remodel

New Construction

LISTING / WARRANTY



L4BLS-10W-3/4K-D90-MW 4" SQUARE RECESSED LED DOME LIGHT

Switch-selectable color temperature

SPECIFICATION

Applications	Recessed Ceiling Mount
Wattage	10W
Light Output	590 lm
CRI	>90
2 CCT	3000K/4000K
Driver Input	120V AC
Power Factor	0.98
Dimming	TRIAC Dimmers 10%-100% (120V only)
Location	Insulated Ceiling
Finish	Matte White
Certification	ETL / ENERGY STAR
Warranty	3 Year Limited for Fixture & Driver
Cut out	D: 3 5/8"
Dimensions	D: 4 1/2" x 4 1/2"

R4-6S-NC New Construction Plate



ETL listed to US and Canadian standards for damp location W/Feed through.
ENERGY STAR
3 Years Limited Warranty.

LIGHT DISTRIBUTION CURVE

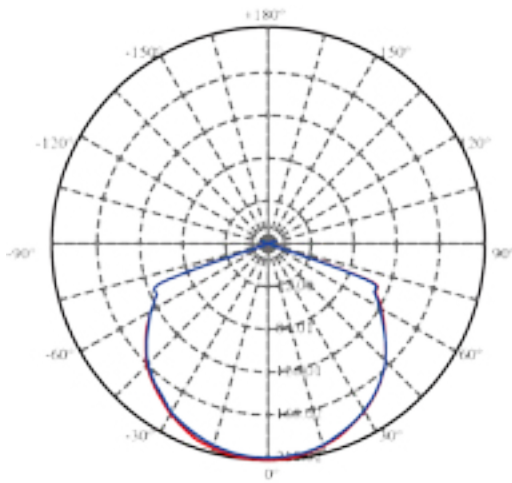

C0/C180: —
 C90/C270: —
 Field angle(10%lmax) C0/180Left:74.0 Right:74.0
 C90/270Left:74.0 Right:74.0
 Beam Angle(50%lmax) C0/180Left:70.1 Right:69.0
 C90/270Left:70.2 Right:69.1

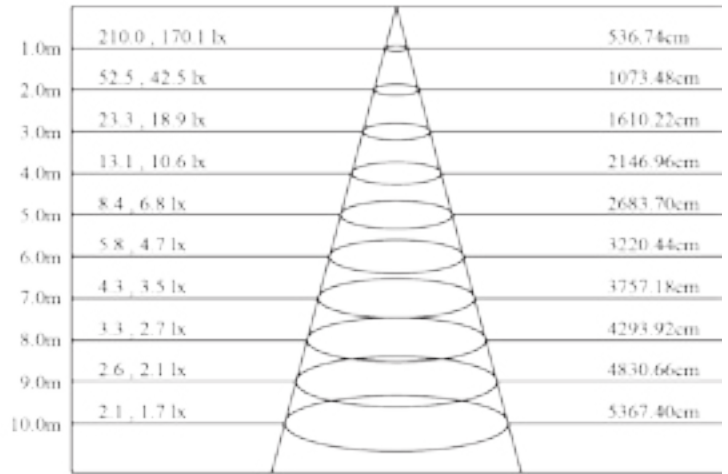

Max , Ave Beam angle of C0plane139.10

OPTION



R-277V PS

- 277 V Power supply
- Dimmable with 0-10 volts dimmers only

APPLICATION





www.beachlightingusa.com



DESCRIPTION

Beach Lighting Interior Dome Lights are designed to reduce glare and improve the light quality. Achieves soft lighting without seeing the source. Lights are available with LED Lighting technology and offer a stylish sleek appearance.

FEATURES

Achieve soft lighting without seeing the light source.
No glare or light distortion.
Die cast aluminum body material with good heat dissipation.
Higher reflection rate reflector with nano powder sprayed on surface
Use FT4 wire with high flame retardant grade Independent drive junction box, easy to replace
Can be installed in 0.5" to 1.25" thick ceilings safe isolated power supply
Flicker free stable dimming, can be compatible with multi brand dimmers

MOUNTING

ETL listed to US and Canadian standards for damp location W/Feed through.
3 Years Limited Warranty.

MOUNTING

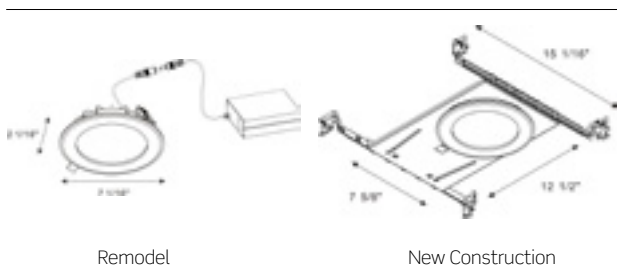

Remodel

New Construction

L6BLR-14W-3/4K-D90-MW 6" ROUND RECESSED LED DOME LIGHT

Switch-selectable color temperature

SPECIFICATION

Applications	Recessed Ceiling Mount
Wattage	14W
Light Output	1080lm
CRI	>90
2 CCT	3000K/4000K
Driver Input	120V AC
Power Factor	0.98
Dimming	TRIAC Dimmers 10%-100% (120V only)
Location	Insulated Ceiling
Finish	Matte White
Certification	ETL / ENERGY STAR
Warranty	3 Year Limited for Fixture & Driver
Cut out	D: 6 1/2"
Dimensions	D: 6 6/8"

R2.5-4-6NC New Construction Plate



LISTING / WARRANTY



ETL listed to US and Canadian standards for damp location W/Feed through.
ENERGY STAR
3 Years Limited Warranty.

LIGHT DISTRIBUTION CURVE

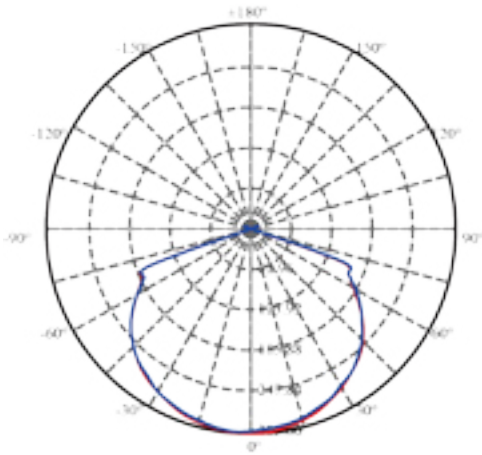

C0/C180: —
 C90/C270: —
 Field angle(10%lmax) C0/180L:left:74.0 Right:73.9
 C90/270L:left:74.1 Right:73.9
 Beam Angle(50%lmax) C0/180L:left:70.2 Right:67.3
 C90/270L:left:70.3 Right:67.8

1.0m	309.8 , 253.1 lx	516.39cm
2.0m	77.5 , 63.3 lx	1032.78cm
3.0m	34.4 , 28.1 lx	1549.17cm
4.0m	19.4 , 15.8 lx	2065.55cm
5.0m	12.4 , 10.1 lx	2581.94cm
6.0m	8.6 , 7.0 lx	3098.33cm
7.0m	6.3 , 5.2 lx	3614.72cm
8.0m	4.8 , 4.0 lx	4131.11cm
9.0m	3.8 , 3.1 lx	4647.50cm
10.0m	3.1 , 2.5 lx	5163.88cm

Max , Ave Beam angle of C0plane:137.46

APPLICATION





www.beachlightingusa.com



DESCRIPTION

Beach Lighting Interior Dome Lights are designed to reduce glare and improve the light quality. Achieves soft lighting without seeing the source. Lights are available with LED Lighting technology and offer a stylish sleek appearance.

FEATURES

Achieve soft lighting without seeing the light source.
No glare or light distortion.
Die cast aluminum body material with good heat dissipation
Higher reflection rate reflector with nano powder sprayed on surface
Use FT4 wire with high flame retardant grade Independent drive junction box, easy to replace
Can be installed in 0.5" to 1.25" thick ceilings safe isolated power supply
Flicker free stable dimming, can be compatible with multi brand dimmers

MOUNTING

ETL listed to US and Canadian standards for damp location W/Feed through.
3 Years Limited Warranty.

MOUNTING

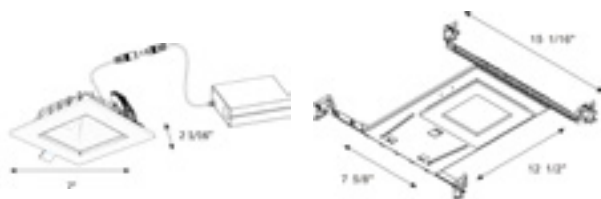

Remodel

New Construction

LISTING / WARRANTY



L6BLS-14W-3/4K-D90-MW 6" SQUARE RECESSED LED DOME LIGHT

Switch-selectable color temperature

SPECIFICATION

Applications	Recessed Ceiling Mount
Wattage	14W
Light Output	920lm
CRI	>90
2 CCT	3000K/4000K
Driver Input	120V AC
Power Factor	0.98
Dimming	TRIAC Dimmers 10%-100% (120V only)
Location	Insulated Ceiling
Finish	Matte White
Certification	ETL / ENERGY STAR
Warranty	3 Year Limited for Fixture & Driver
Cut out	D: 5 1/2"
Dimensions	D: 6 1/4" x 6 1/4"

R4-6S-NC New Construction Plate



ETL listed to US and Canadian standards for damp location W/Feed through.
ENERGY STAR
3 Years Limited Warranty.

LIGHT DISTRIBUTION CURVE

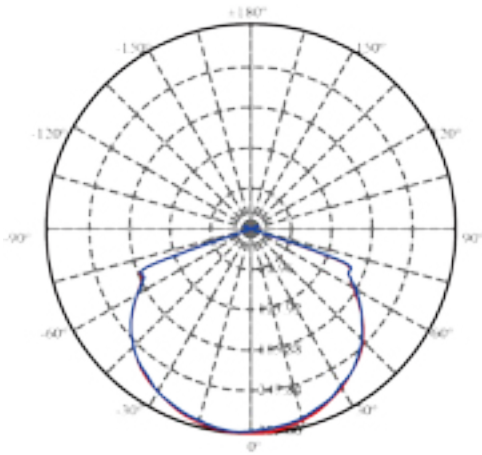

C0/C180: —
 C90/C270: —

Field angle(10%lmax) C0/180L:left:74.0 Right:73.9
 C90/270Left: 74.1 Right: 73.9

Beam Angle(50%lmax) C0/180Left:70.2 Right:67.3
 C90/270Left:70.3 Right:67.8

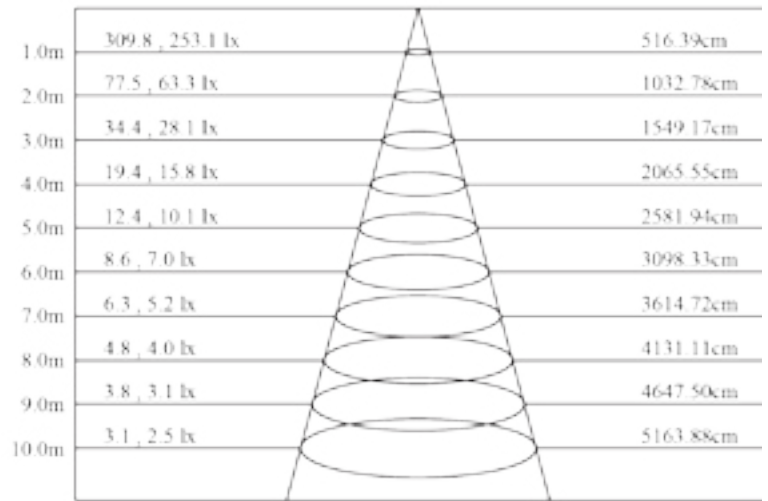

Max , Ave Beam angle of C0plane:137.46

APPLICATION





www.beachlightingusa.com

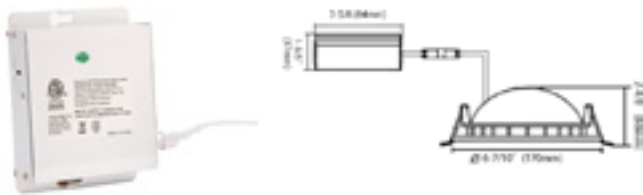

DESIGNER LED PANEL

L6BLRD | L6BLRW SERIES

L6BLRD-10W-3/4K-D90-MW

6" ROUND DESIGNER BACK LIT PANEL

Switch-selectable color temperature

SPECIFICATION	
Wattage	10 W
Light Output	650lm
CRI	>90
CCT	3000K - 4000K
IC	Can Have Direct Contact With Insulation
Dimming	Triac / ELV Dimmers
Finish	Matte White
Certification	ETL
Dimensions	D: 6 7/10" H: 2 4/8"
Cut Out	6 1/10"

L6BLRW-10W-3/4K-D90-MW

6" ROUND DESIGNER BACK LIT PANEL

Switch-selectable color temperature

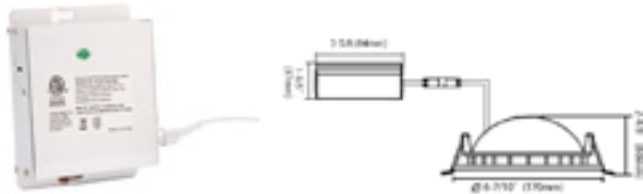

SPECIFICATION	
Wattage	10 W
Light Output	650lm
CRI	>90
CCT	3000K - 4000K
IC	Can Have Direct Contact With Insulation
Dimming	Triac / ELV Dimmers
Finish	Matte White
Certification	ETL
Dimensions	D: 6 7/10" H: 2 4/8"
Cut Out	6 1/10"

FOR ADDITIONAL ACCESSORIES SEE PAGE 134

ETL listed to US and Canadian standards for damp location W/Feed through.
3 Years Limited Warranty.





www.beachlightingusa.com

R6-BLR-12RETRO-3D90-MW

6" ROUND BACK LIT RETROFIT

LED BACK LIT PANEL



SPECIFICATION	
Applications	Adapts to E26 Base 6" Housing
Wattage	12W
Light Output	600lm
CRI	>90
CCT	3000K
Dimming	Dimmable Triac / ELV Dimmers
Finish	Matte White
Certification	ETL

Recommended for use with new construction housings only.

APPLICATION





www.beachlightingusa.com

3" RECESSED LIGHTS

3" DesignerTrims	98
3" Recessed Trims	99
3" Die Cast Trims	103
3" Shower Trims	105
3" Line Voltage Housings	106







www.beachlightingusa.com

3" DESIGNER TRIMS

R3-4765 | R3-5765

MW
SN



R3-4765

3" SQUARE ALUMINUM STEP EDGE TRIM

Unique holder centers the light source .
Line and low voltage applications.
Accommodates a MR-16 or GU-10 lamp.

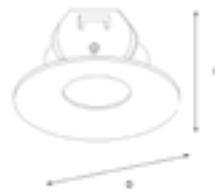

DIMENSIONS
D: 3 7/8"
H: 2"

SN
MW



R3-5765

3" SQUARE ALUMINUM TRIM

Unique holder centers the light source .
Line and low voltage applications.
Accommodates a MR-16 or GU-10 lamp.



DIMENSIONS
D: 3 13/16"
H: 2"

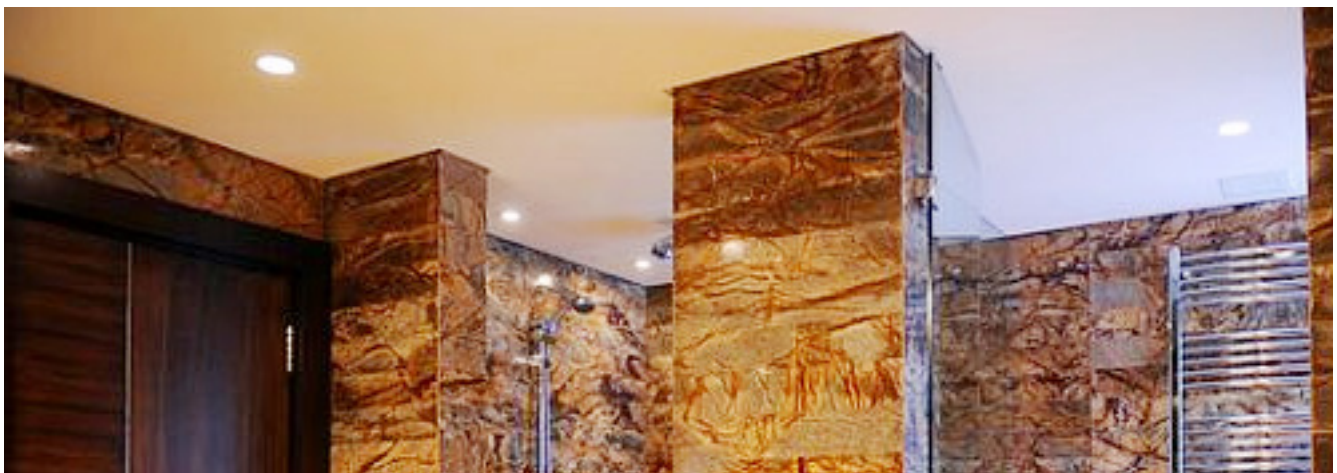

3" RECESSED TRIMS

R3-421 | R3-488 | R3-488DG

MWAA
CCL
MW
MWCL



R3-421

3" ROUND ADJUSTABLE ALZAK TRIM

Trim will adjust 15° from vertical position.
Line and low voltage applications.
Accommodates a MR-16 or GU-10 lamp.

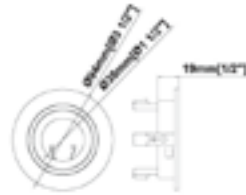

DIMENSIONS
D: 3 1/2"
H: 1/2"

BN
MW



R3-488

3" ROUND ADJUSTABLE TRIM

Trim will adjust 35° from vertical position.
Line and low voltage applications.
Accommodates a MR-16 or GU-10 lamp.

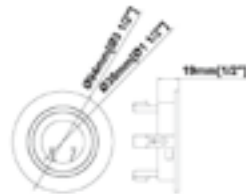

DIMENSIONS
D: 3 1/2"
H: 1/2"

MW



R3-488DG

3" ROUND DOUBLE GIMBAL TRIM

Trim will pivot 360° and adjust 35° from vertical position.
Line and low voltage applications.
Accommodates a MR-16 or GU-10 lamp.

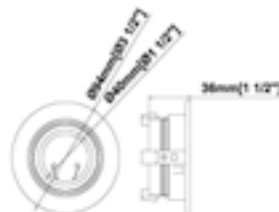

DIMENSIONS
D: 3 1/2"
H: 1 1/2"



www.beachlightingusa.com

MW
MWB



3" RECESSED TRIMS

R3-493 | R3-521 | R3-555

R3-493

3" ROUND BAFFLE TRIM

Trim will adjust 15° from vertical position.
Line and low voltage applications.
Accommodates a MR-16 or GU-10 lamp.



DIMENSIONS

D: 3 1/2"

H: 1/2"

MWCL
BNCL
MW



R3-521

3" SQUARE ADJUSTABLE ALZAK TRIM

Trim will adjust 15° from vertical position.
Line and low voltage applications.
Accommodates a MR-16 or GU-10 lamp.

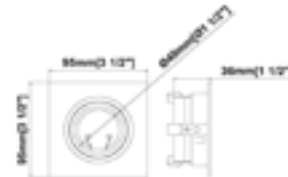

DIMENSIONS

D: 3 1/2"

H: 1 1/2"

MW
BN



R3-555

3" SQUARE ON SQUARE APERTURE TRIM

Trim will adjust 15° from vertical position.
Line and low voltage applications.
Accommodates a MR-16 or GU-10 lamp.



DIMENSIONS

D: 3 1/2"

H: 1 3/4"

3" RECESSED TRIMS

R3-588 | R3-588DG | R3-590

BN
MW



R3-588

3" SQUARE ADJUSTABLE TRIM

Trim will adjust 35° from vertical position.
Line and low voltage applications.
Accommodates a MR-16 or GU-10 lamp.



DIMENSIONS
D: 3 1/2"
H: 1/2"

MW



R3-588DG

3" SQUARE DOUBLE GIMBAL TRIM

Trim will pivot 360° and adjust 35° from vertical position.
Line and low voltage applications.
Accommodates a MR-16 or GU-10 lamp.



DIMENSIONS
D: 3 1/2"
H: 1/2"

BN
MW



R3-590

3" SQUARE ON SQUARE BAFFLE TRIM

Trim will adjust 15° from vertical position.
Line and low voltage applications.
Accommodates a MR-16 or GU-10 lamp.

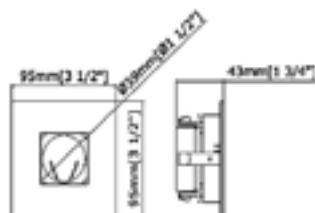

DIMENSIONS
D: 3 1/2"
H: 1 3/4"



www.beachlightingusa.com

3" RECESSED TRIMS

R3-593

MW



R3-593

3" SQUARE BAFFLE TRIM

Trim will adjust 15° from vertical position.
Line and low voltage applications.
Accommodates a MR-16 or GU-10 lamp.

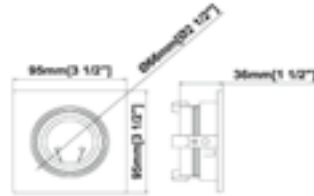

DIMENSIONS
D: 3 1/2"
H: 1 1/2"





www.beachlightingusa.com

MW
BN



3" DIE CAST TRIMS

R3-DR488 | R3-DR88 | R3-DS88

R3-DR488

3" DIE-CAST ROUND ADJUSTABLE TRIM

Trim will adjust 35° from vertical position.
Line and low voltage applications.
Accommodates a MR-16 or GU-10 lamp.

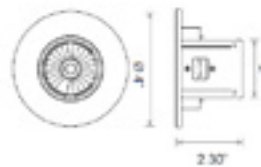

DIMENSIONS

D: 4"

H: 2 5/16"

MW
BN



R3-DR88

3" DIE-CAST ROUND ADJUSTABLE TRIM

Trim will adjust 35° from vertical position.
Line and low voltage applications.
Accommodates a MR-16 or GU-10 lamp.

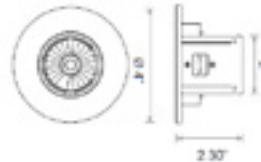

DIMENSIONS

D: 4"

H: 2 5/16"

MW
BN



R3-DS88

3" DIE-CAST SQUARE ADJUSTABLE TRIM

Trim will adjust 35° from vertical position.
Line and low voltage applications.
Accommodates a MR-16 or GU-10 lamp.

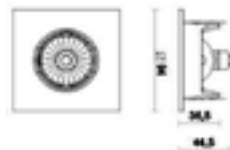

DIMENSIONS

D: 3 11/16"

H: 1 7/16"



www.beachlightingusa.com

3" DIE CAST TRIMS

R3-DS90 | R3-DS589

3" DIE CAST TRIMS

MW
BN



R3-DS90

3" DIE-CAST SQUARE ON SQUARE REGRESSED BAFFLE TRIM

Line and low voltage applications.
Accommodates a MR-16 or GU-10 lamp.

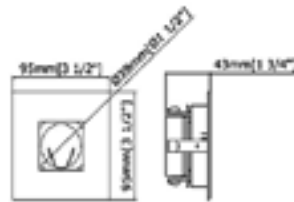

DIMENSIONS
D: 3 1/2"
H: 1 3/4"

MW



R3-DS589

3" DIE-CAST SQUARE ON SQUARE REGRESSED ALZAK TRIM

Line and low voltage applications.
Accommodates a MR-16 or GU-10 lamp.

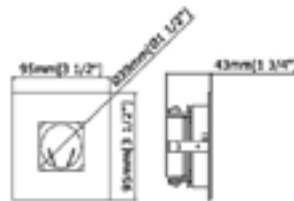

DIMENSIONS
D: 3 1/2"
H: 1 3/4"

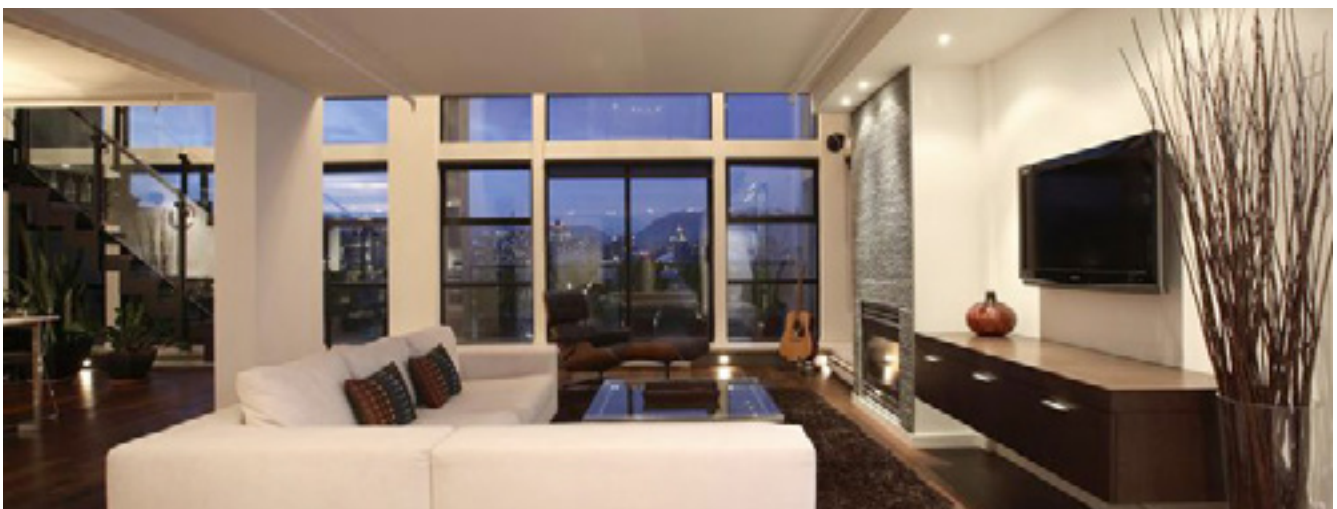



www.beachlightingusa.com

3" SHOWER TRIMS

R3-409 | R3-508 | R3-559

3" SHOWER TRIMS

MW
BN
MW-MG



****Available in Marine Grade finish**

R3-409

3" ROUND SHOWER TRIM WITH FLAT FROSTED GLASS

Line and low voltage applications.
Accommodates a MR-16 or GU-10 lamp.
(Damp Location).



DIMENSIONS

D: 3 1/2"

H: 1 1/2"

MW
BN
MW-MG



****Available in Marine Grade finish**

R3-508

3" SQUARE ON SQUARE SHOWER TRIM WITH CLEAR GLASS

Line and low voltage applications.
Accommodates a MR-16 or GU-10 lamp.
(Damp Location).

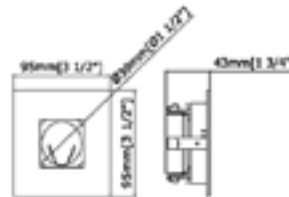

DIMENSIONS

D: 3 1/2"

H: 1 3/4"

BN
MW
MW-MG



****Available in Marine Grade finish**

R3-559

3" SQUARE ON SQUARE SHOWER TRIM WITH FLAT FROSTED GLASS

Line and low voltage applications.
Accommodates a MR-16 or GU-10 lamp.
(Damp Location).

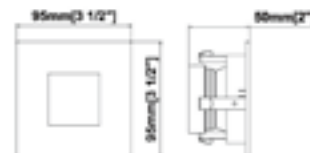

DIMENSIONS

D: 3 1/2"

H: 2"



www.beachlightingusa.com

3" LINE VOLTAGE HOUSINGS

R3-GUICAT | R3-GUICRAT

R3-GUICAT

3" NEW CONSTRUCTION HOUSING

IC Rated when using an LED lamp Max. 10 watt Can have direct contact with insulation

Non IC when using a Halogen lamp Max 50 watt.

3" clearance on all sides from insulation required

Airtight in compliance to the WSEC-Washington State Energy Code

Suitable for damp locations



DIMENSIONS:

Cut out: 3 1/4" Height: 4 1/4"

R3-GUICRAT

3" REMODEL HOUSING

IC Rated when using an LED lamp Max. 10 watt Can have direct contact with insulation

Non IC when using a Halogen lamp Max 50 watt.

3" clearance on all sides from insulation required

Airtight in compliance to the WSEC-Washington State Energy Code

Suitable for damp locations



DIMENSIONS:

Cut out: 3 1/4" Height: 4 1/4"

LISTING / WARRANTY

ETL listed to US and Canadian standards for damp location W/Feed through.
3 Years Limited Warranty.





4" RECESSED LIGHTING

4" Designer Trims	110
4" Recessed Trims	111
4" Die Cast Trims	116
4" Shower Trims	118
4" Trim-less Trims	120
4" Line Voltage Housings	122







www.beachlightingusa.com

4" DESIGNER TRIMS

R4-4765 | R4-5765 |

MW
SN



R4-4765

4" ROUND ALUMINUM TRIM

Unique holder centers the light source .
Line and low voltage applications.
Accommodates a MR-16 or GU-10 lamp.

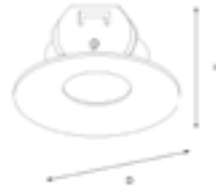

DIMENSIONS
D: 4 7/8"
H: 2"

SN
MW



R4-5765

4" SQUARE ALUMINUM TRIM

Unique holder centers the light source .
Line and low voltage applications.
Accommodates a MR-16 or GU-10 lamp.



DIMENSIONS
D: 4 7/8"
H: 2"

SEE PAGE 137 FOR COMPATIBLE HOUSINGS



www.beachlightingusa.com

MW
BNCL
MWAA
MWCL



4" RECESSED TRIMS

R4-421 | R4-488 | R4-488DG

4" RECESSED TRIMS

R4-421

4" ROUND ADJUSTABLE ALZAK TRIM

Trim will adjust 15° from vertical position.
Line and low voltage applications.
Accommodates a MR-16 or GU-10 lamp.

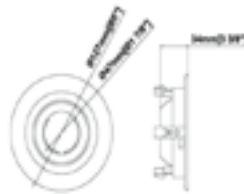

DIMENSIONS
D: 5"
H: 3 3/8"

BN
MW



R4-488

4" ROUND ADJUSTABLE TRIM

Trim will adjust 35° from vertical position.
Line and low voltage applications.
Accommodates a MR-16 or GU-10 lamp.

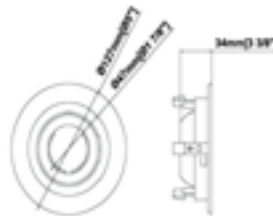

DIMENSIONS
D: 5"
H: 3 3/8"

MW



R4-488DG

4" ROUND DOUBLE ADJUSTABLE TRIM

Trim will pivot 360° and adjust 35° from vertical position.
Line and low voltage applications.
Accommodates a MR-16 or GU-10 lamp.

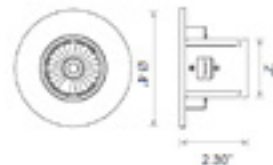

DIMENSIONS
D: 4"
H: 2 5/16"

SEE PAGE 137 FOR COMPATIBLE HOUSINGS



www.beachlightingusa.com

4" RECESSED TRIMS

R4-493 | R4-520 | R4-521

MW
MWB



R4-493

4" ROUND ADJUSTABLE BAFFLE TRIM

Trim will adjust 15° from vertical position.
Line and low voltage applications.
Accommodates a MR-16 or GU-10 lamp.



DIMENSIONS
D: 5"
H: 2"

MWB
MW

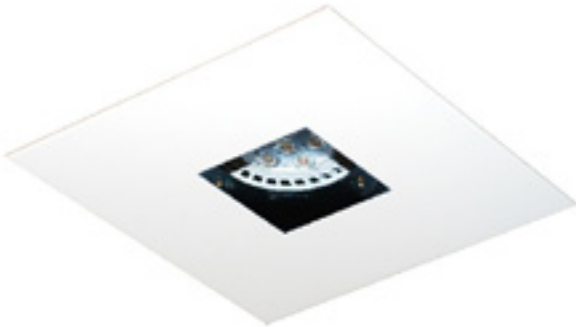

R4-520

4" SQUARE ON SQUARE APERTURE TRIM

Trim will adjust 35° from vertical position.
Line and low voltage applications.
Accommodates a MR-16 or GU-10 lamp.

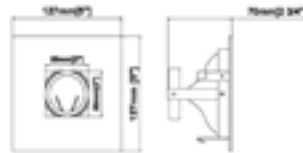

DIMENSIONS
D: 5"
H: 2 3/4"

****Available in Marine Grade finish**

SEE PAGE 137 FOR COMPATIBLE HOUSINGS

MW



R4-521

4" SQUARE ALZAK TRIM

Trim will adjust 10° from vertical position.
Line and low voltage applications.
Accommodates a MR-16 or GU-10 lamp.

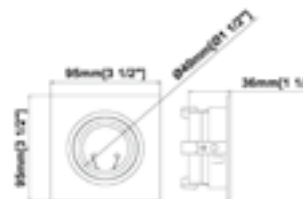

DIMENSIONS
D: 3 1/2"
H: 1 1/2"



www.beachlightingusa.com

MW
MWA
MWB
BN



4" RECESSED TRIMS

R4-545 | R4-587 | R4-588

4" RECESSED TRIMS

R4-545

4" SQUARE ON SQUARE ADJUSTABLE ALZAK TRIM

Trim will adjust 10° from vertical position.
Line and low voltage applications.
Accommodates a MR-16 or GU-10 lamp.

(CAN NOT BE USED WITH SHALLOW HOUSINGS)

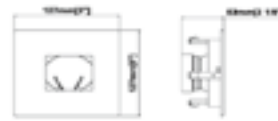

DIMENSIONS
D: 5"
H: 2 1/8"

MW
BN



R4-587

4" SQUARE ON SQUARE ADJUSTABLE APERTURE TRIM

Trim will adjust 15° from vertical position.
Line and low voltage applications.
Accommodates a MR-16 or GU-10 lamp.

(CAN NOT BE USED WITH SHALLOW HOUSINGS)



DIMENSIONS
D: 5"
H: 3 3/4"

BN
MW



R4-588

4" SQUARE ADJUSTABLE TRIM

Trim will adjust 35° from vertical position.
Line and low voltage applications.
Accommodates a MR-16 or GU-10 lamp.

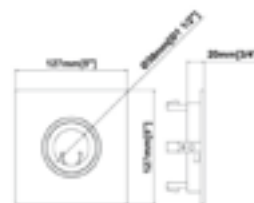

DIMENSIONS
D: 5"
H: 3/4"

SEE PAGE 137 FOR COMPATIBLE HOUSINGS



www.beachlightingusa.com

4" RECESSED TRIMS

R4-588DG | R4-589 | R4-590

MW



R4-588DG

4" SQUARE ADJUSTABLE DOUBLE GIMBAL TRIM

Trim will pivot 360° and adjust 35° from vertical position.
Line and low voltage applications.
Accommodates a MR-16 or GU-10 lamp.

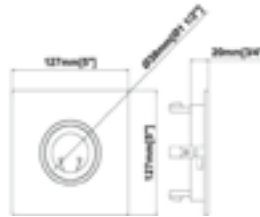

DIMENSIONS
D: 5"
H: 3/4"

MW
BN



R4-589

4" SQUARE ON SQUARE ALZAK TRIM

Trim will adjust 15° from vertical position.
Line and low voltage applications.
Accommodates a MR-16 or GU-10 lamp.

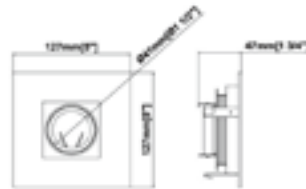

DIMENSIONS
D: 5"
H: 1 3/4"

****Available in Marine Grade finish**

BN
MW



R4-590

4" SQUARE ON SQUARE BAFFLE TRIM

Trim will adjust 15° from vertical position.
Line and low voltage applications.
Accommodates a MR-16 or GU-10 lamp.

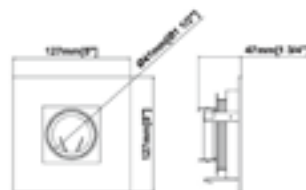

DIMENSIONS
D: 5"
H: 1 3/4"

SEE PAGE 137 FOR COMPATIBLE HOUSINGS



www.beachlightingusa.com

4" RECESSED TRIMS

R4-593

4" RECESSED TRIMS

MW



R4-593

4" SQUARE BAFFLE TRIM

Trim will adjust 15° from vertical position.
Line and low voltage applications.
Accommodates a MR-16 or GU-10 lamp.

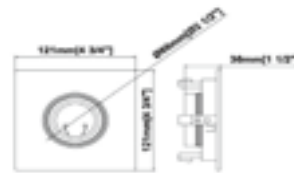

DIMENSIONS

D: 4 3/4"

H: 1 1/5"



SEE PAGE 137 FOR COMPATIBLE HOUSINGS



www.beachlightingusa.com

4" DIE CAST TRIMS

R4-DR488 | R4-DR88 | R4-DS88

MW
BN



R4-DR488

4" DIE-CAST ROUND ADJUSTABLE TRIM

Trim will adjust 35° from vertical position.
Line and low voltage applications.
Accommodates a MR-16 or GU-10 lamp.

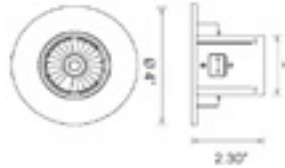

DIMENSIONS
D: 4"
H: 2 5/16"

MW
BN



R4-DR88

4" DIE-CAST ROUND ADJUSTABLE TRIM

Trim will adjust 35° from vertical position.
Line and low voltage applications.
Accommodates a MR-16 or GU-10 lamp.

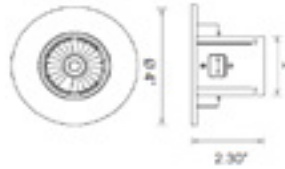

DIMENSIONS
D: 4"
H: 2 5/16"

SEE PAGE 137 FOR COMPATIBLE HOUSINGS

MW
BN



R4-DS88

4" DIE-CAST SQUARE ADJUSTABLE TRIM

Trim will adjust 35° from vertical position.
Line and low voltage applications.
Accommodates a MR-16 or GU-10 lamp.

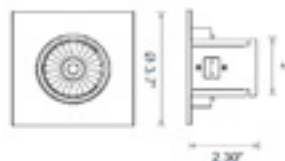

DIMENSIONS
D: 3 11/16"
H: 2 5/16"



www.beachlightingusa.com

4" DIE CAST TRIMS

R4-DS90 | R4-DS589

4" DIE CAST TRIMS

MW



R4-DS90

4" DIE-CAST SQUARE ON SQUARE TRIM

Trim will adjust 35° from vertical position.
Line and low voltage applications.
Accommodates a MR-16 or GU-10 lamp.

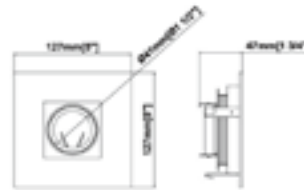

DIMENSIONS

D: 5"

H: 1 3/4"

MW



R4-DS589

4" DIE-CAST SQUARE ON SQUARE TRIM

Line and low voltage applications.
Accommodates a MR-16 or GU-10 lamp.

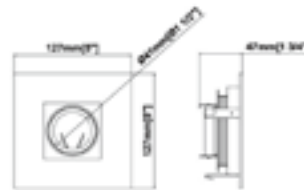

DIMENSIONS

D: 5"

H: 1 3/4"



SEE PAGE 137 FOR COMPATIBLE HOUSINGS



www.beachlightingusa.com

4" SHOWER TRIMS

R4-409

BN
MW
MW-MG



R4-409

4" ROUND SHOWER TRIM WITH FLAT FROSTED GLASS

Line and low voltage applications.
Accommodates a MR-16 or GU-10 lamp.
(Damp Location)

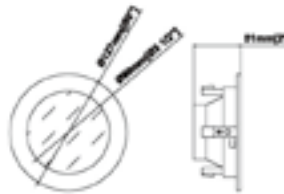

DIMENSIONS

D: 5"

H: 2"

****Available in Marine Grade finish**

SEE PAGE 137 FOR COMPATIBLE HOUSINGS



4" SHOWER TRIMS

R4-508 | R4-549 | R4-579

MW
BN
MW-MG

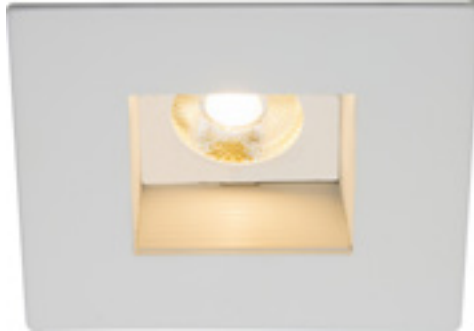

****Available in Marine Grade finish**

R4-508

4" SQUARE ON SQUARE SHOWER TRIM WITH CLEAR GLASS

Line and low voltage applications
Accommodates a MR-16 or GU-10 lamp.
(Damp Location)
(CANNOT BE USED WITH SHALLOW HOUSNGS)

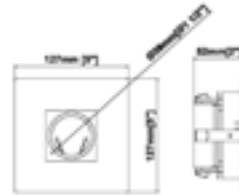

DIMENSIONS
D: 5"
H: 2"

MW
MW-MG



****Available in Marine Grade finish**

R4-549

4" SQUARE ON SQUARE SHOWER TRIM WITH FLAT FROSTED GLASS

Line and low voltage applications.
Accommodates a MR-16 or GU-10 lamp.
(Damp Location)
(CANNOT BE USED WITH SHALLOW HOUSNGS)

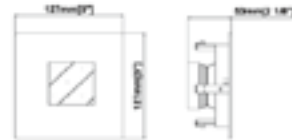

DIMENSIONS
D: 5"
H: 2 1/8"

MW
BN
MW-MG

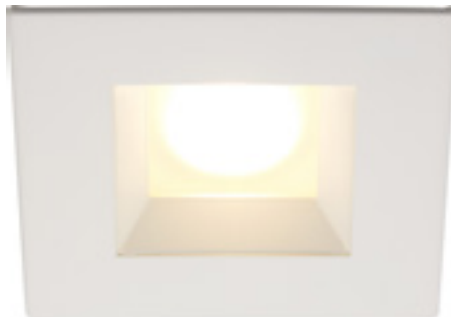

****Available in Marine Grade finish**

R4-579

4" SQUARE ON SQUARE SHOWER TRIM WITH REGRESSED FROSTED GLASS

Line and low voltage applications.
Accommodates a MR-16 or GU-10 lamp.
(Damp Location)
(CANNOT BE USED WITH SHALLOW HOUSNGS)

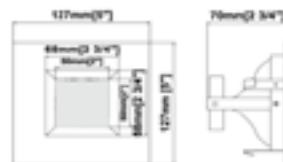

DIMENSIONS
D: 5"
H: 2 3/4"



www.beachlightingusa.com

4" TRIM-LESS TRIMS

R4-421TL | R4-589TL

MW



R4-421TL

4" ROUND TRIM-LESS TRIM

For use with NEW CONSTRUCTION housings only .
Line voltage applications.
Accommodates GU-10 LED lamps via twist and lock access from bottom of trim.

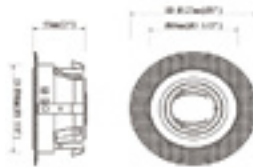

DIMENSIONS

D: 5"

H: 2"

MW



R4-589TL

4" Square Trim-less trim

For use with NEW CONSTRUCTION housings only.
Line voltage applications.
Accommodates GU-10 LED lamps via twist and lock access from bottom of trim.

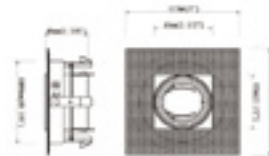

DIMENSIONS

D: 5"

H: 1 7/8"

SEE PAGE 137 FOR COMPATIBLE HOUSINGS

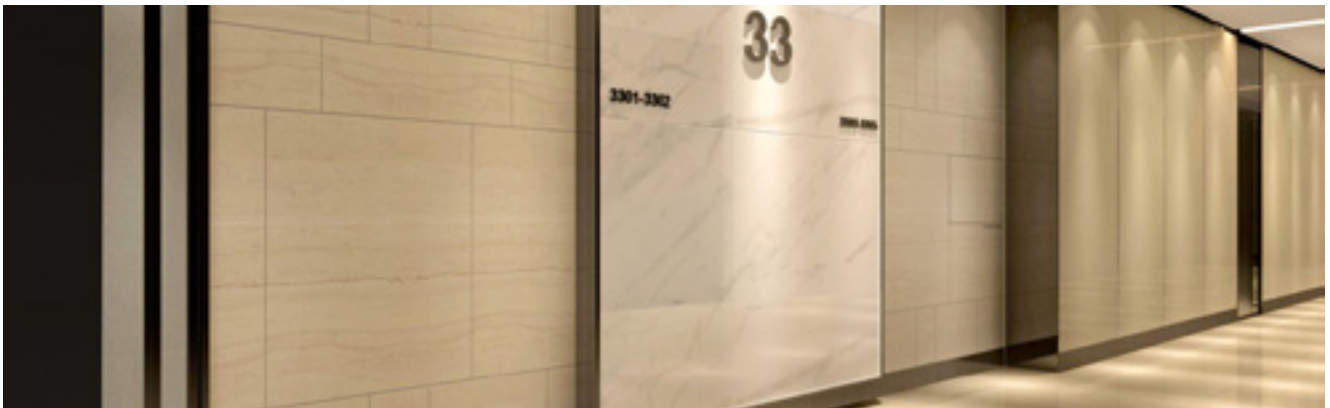



Trims are compatible with NEW CONSTRUCTION housings only!!!



Must use Dura-bond during installation and follow instructions by Beach Lighting.
Product is designed to access light source via twist and lock mechanism from bottom of the trim.



www.beachlightingusa.com

4" LINE VOLTAGE HOUSINGS

R4-GUICAT | R4-GUICRAT

R4-GUICAT

4" NEW CONSTRUCTION HOUSING

4" NEW CONSTRUCTION IC HOUSING

Max. 12W GU-10 LED lamp only

IC: Can have direct contact with insulation

Non IC: when using a regular Halogen lamp

Airtight in compliance to the WSEC-Washington State Energy Code

Suitable for damp locations

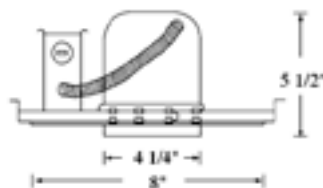

DIMENSIONS:

Cut out: 4 1/4" Height: 5 1/4"

R4-GUICRAT

4" REMODEL HOUSING

4" NEW CONSTRUCTION IC HOUSING

Max. 12W GU-10 LED lamp only

IC: Can have direct contact with insulation

Non IC: when using a regular Halogen lamp

Airtight in compliance to the WSEC-Washington State Energy Code

Suitable for damp locations



DIMENSIONS:

Cut out: 4 1/4" Height: 5 5/8"

LISTING / WARRANTY

ETL listed to US and Canadian standards for damp location W/Feed through.
3 Years Limited Warranty.





www.beachlightingusa.com

4" LINE VOLTAGE HOUSINGS

R4-G19SAT | R4-G19SRAT

4" LINE VOLTAGE HOUSINGS



R4-G19SAT

4" NEW CONSTRUCTION SHALLOW HOUSING

Shallow Housing

35W GU-10 Halogen or LED lamp

Non-IC: 3" clearance on all sides from insulation required

Airtight in compliance to the WSEC-Washington State Energy Code

Suitable for damp locations

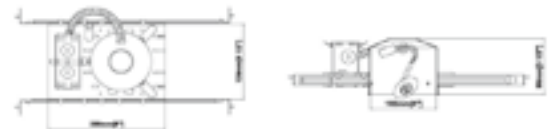

DIMENSIONS:

Cut out: 4 1/4" Height: 3 1/2"



R4-G19SRAT

4" REMODEL SHALLOW HOUSING

Shallow Housing

35W GU-10 Halogen or LED lamp

Non-IC: 3" clearance on all sides from insulation required

Airtight in compliance to the WSEC-Washington State Energy Code

Suitable for damp location



DIMENSIONS:

Cut out: 4 1/4" Height: 3 1/2"

LISTING / WARRANTY

ETL listed to US and Canadian standards for damp location W/Feed through.
3 Years Limited Warranty.





www.beachlightingusa.com

THE WAVE UNDERCOUNTER LIGHTING SYSTEM

Wave Kits	126
Wave Lights	127
Connectors / Controls	128
Power Supplies	129







www.beachlightingusa.com

UNDERCOUNTER LIGHTING

LUC-2PK | LUC-3PK



LUC-2PK 3000K

SECTIONS 12" LED FIXTURES

- (2) Sections 12" LED fixtures
- (3) Jumper cable connectors and
- (2) Direct connectors
- (1) AC/DC 24V plug adaptor
- (1) Wave sensor
- (5) Mounting clips
- (1) LED end cap
- (2) 3M double side tape included



LUC-3PK 3000K

SECTIONS 12" LED FIXTURES

- (3) Sections 12" LED Fixtures
- (4) Jumper cable connectors and
- (2) Direct connectors
- (1) AC/DC 24V plug adaptor
- (1) Wave sensor
- (7) Mounting clips
- (2) LED end cap
- (3) 3M double side tape included

APPLICATION

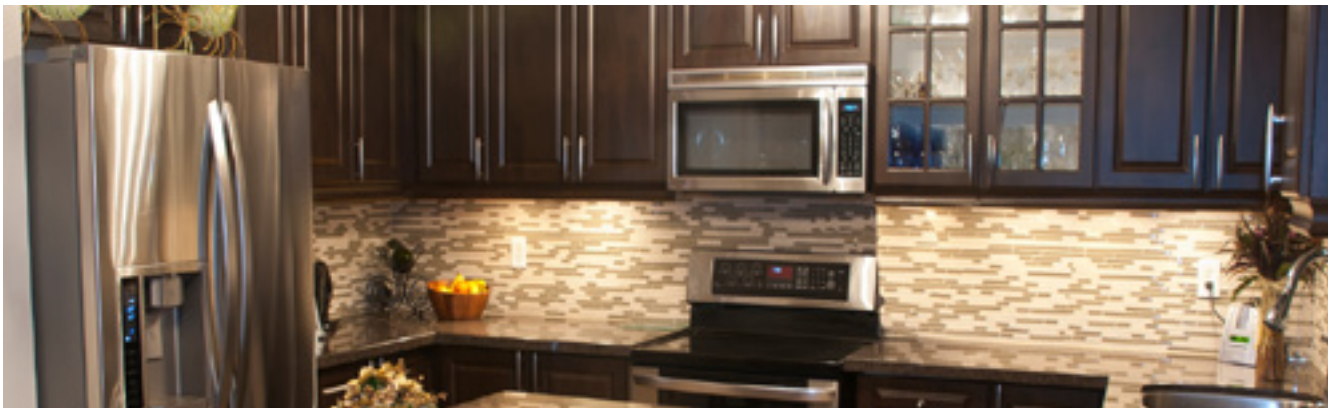



www.beachlightingusa.com

UNDERCOUNTER LIGHTING

LUC-8-3K | LUC-12-3K | LUC-24-3K

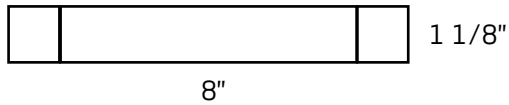

LUC-8-3K 3000K

8" LED UNDERCOUNTER LIGHTING

- 3.8W per section
- 170 Lumens
- Straight and direct connector
- End cap
- Mounting hardware included
- 5/16" depth

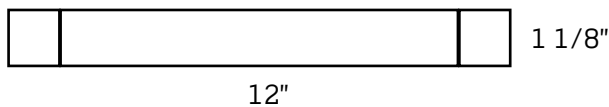

LUC-12-3K 3000K

12" LED UNDERCOUNTER LIGHTING

- 5W per section
- 220 Lumens
- Straight and direct connector
- End cap
- Mounting hardware included
- 5/16" depth

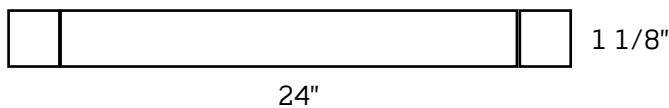

LUC-24-3K 3000K

24" LED UNDERCOUNTER LIGHTING

- 10W per section
- 440 Lumens
- Straight and direct connector
- End cap
- Mounting hardware included
- 5/16" depth



www.beachlightingusa.com

UNDERCOUNTER LIGHTING

LUC-CONNECTOR | LUC-SWITCH
LUC-JUMPER | LUC-MOTION



LUC-CONNECTOR

LUC-JC-4 4" connector
LUC-JC-6 6" connector
LUC-JC-10 10" connector
LUC-JC-48 48" connector
LUC-JC-60 60" connector



LUC-SWITCH

LUC-WM Wave On/Off
LUC-WM-DIM Wave Dimming Module



LUC-JUMPER

LUC-JUMPER-MODULE
Connects cables to extend run



LUC-MOTION

LUC-MOTION DETECTOR
Occupancy sensor
Detects movement up to 5 feet radius.



www.beachlightingusa.com

UNDERCOUNTER LIGHTING

LUC-HCC-8 | LUC-HWB BOX | LUC-P PLUG IN



LUC-HCC-8

8" HARDWIRE

- 8" hardwire cable that connects a secondary run from the power supply
- Compatible with The Wave hardwire boxes.



LUC-HWB BOX

HARDWIRE BOX

- LUC-HWB-72 Max run 84" or up to 30 watts
- LUC-HWB-120 Max run 120" or up to 50 watts

** SYSTEM NOT COMPATIBLE WITH WALL DIMMERS



LUC-P PLUG IN

PLUG IN TRANSFORMER

- LUC-P-48 Plug in up to 48" or up to 20 watts
- LUC-P-72 Plug in up to 72" or up to 30 watts

ALLOWS WAVE SYSTEM TO BE PLUGGED DIRECTLY INTO AC/DC OUTLET

** SYSTEM IS NOT COMPATIBLE WITH WALL DIMMERS



www.beachlightingusa.com

LED LAMPS

GU-10 LED	132
Dimmer Compatibility	133
Accessories	134







www.beachlightingusa.com

LED LAMPS

LBGU-7.5 LAMP
LTGUCCOB LAMP
LMGUCOB-7 LAMP



LBGU-7.5 LAMP

LBGU-7.5-D-30-40
LBGU-7.5-D-40-40

*Last 2 Numbers Are Color Temperature And Beam Spread

- GU-10 Base
- Dimmable 7.5 watt 700 Lumens
- SMD technology for stable illumination
- Aluminum construction



LTGUCCOB LAMP

LTGUCCOB-8-D-27-40
LTGUCCOB-8-D-30-40
LTGUCCOB-8-D-30-60
LTGUCCOB-8-D-40-40
LTGUCCOB-8-D-50-40

*Last 2 Numbers Are Color Temperature And Beam Spread

- GU-10 Base
- Dimmable 8 watt 650+ Lumens
- 80 CRI
- Available in various color temperatures



LMGUCOB-7 LAMP

LMGUCOB-7-D-27-30	LMGUCOB-7-D-30-38
LMGUCOB-7-D-27-38	LMGUCOB-7-D-30-30-90
LMGUCOB-7-D-30-25	LMGUCOB-7-D-40-30
LMGUCOB-7-D-30-30	LMGUCOB-7-D-40-38

*Last 2 Numbers Are Color Temperature And Beam Spread

- GU-10 Base
- Dimmable 7 watt 500+ Lumens
- Available in various color temperatures and beam spreads

LED LAMP CHART



LMGUCOB-7 LAMP



LTGUCCOB LAMP



LBGU-7.5 LAMP

MANUFACTURER	MODEL NO.	DIMMING RATE	MANUFACTURER	MODEL NO.	DIMMING RATE
LUTRON	CTCL-153P	10-100%	LEVITON	6631	10-100%
LUTRON	SCL-153P	10-100%	LEVITON	6633-P	10-100%
LUTRON	DVCL-153P	10-100%	LEVITON	IPL06-P-LED/LFC	10-100%
LUTRON	S-600	10-100%	LEVITON	6674-P-LED/LFC	10-100%
LUTRON	S-600P	10-100%	LEVITON	UNIVERSAL SERIES	10-100%
LUTRON	DVELV-300P	10-100%	MANUFACTURER	MODEL NO.	DIMMING RATE
LUTRON	CT-103P	10-100%	LEGRAND	ASPD453LW2	10-100%
LUTRON	DV-600P	10-100%	LEGRAND	ADWR700MMTU W2	10-100%
LUTRON	SCL-153PR-WH	10-100%	LEGRAND	ADTP703TUW4	10-100%
LUTRON	MACL-153MR-WH	10-100%	LEGRAND	ADTH700MMTVW 2	10-100%
LUTRON	TGCL-153PH-WH	10-100%	MANUFACTURER	MODEL NO.	DIMMING RATE
LUTRON	S2-L	10-100%	COOPER	DI06P	10-100%
LUTRON	TG-600P	10-100%			

** Please Consult Factory Before Using Any Unlisted Dimmers.

** Beach Lighting Cannot Guarantee Compatibility With Control Systems.



www.beachlightingusa.com

ACCESSORIES

R-120/277V PS | GU-10 WHIP
3" AND 4" TRIM RINGS | CLIPS 2PK



R-120/277V PS

- 120/277 V Power supply
- Dimmable with 0-10 volts dimmers only
- Compatible with R3-47/57 Series
- Compatible with R4-47/57 Series

R-277V PS

- Dimmable with 0-10 volts dimmers only
- Compatible with L4BLR AND L4BLS slim line panels



GU-10 WHIP

- Used to convert 4" Line Voltage E-26 Base to GU-10 Lamp



LOW VOLTAGE EXTENSIONS

BL-FLEX 6 6 Foot Extension
BL-FLEX 10 10 Foot Extension

- Compatible with our L4 and L6SSG series
- Compatible with our RA2, RA4, R2.5, R3.5 Series
- Compatible with our MR and NR Series.



CLIPS 2PK

- These clips allow for easy installation of a trim without a housing. Sold in packs of two. Only for Die Cast Trims

ACCESSORY APPLICATION

UTILIZING OUR GU-10 WHIP ALLOWS FOR THE COMPATIBILITY OF AN ENERGY EFFICIENT LED LAMP WITHOUT HAVING TO REMOVE YOUR EXISTING HOUSING.



Remove Trim From Your Existing 4 Inch Line Voltage E-26 Housing

+



Screw In Our GU-10 Whip

+



Add Our Energy Efficient Led GU-10 Lamp

+



Choose One Of Our Many Compatible Trims

WHEN HOUSING IS NOT NEEDED ..

IF BUILDING CODES ALLOW, THESE CLIPS CAN BE USED WITH COMPATIBLE TRIMS.

***NOT ETL APPROVED**



Use our Clips (2 to a pack)

+



Add a trim from compatibility list below

=



Trim can now be easily placed in the ceiling

COMPATIBLE TRIMS

R3-DR88

R4-DR88

R3-DS88

R4-DS88

R3-DR488

R4-DR488





www.beachlightingusa.com

COMPATIBLE 4 INCH HOUSINGS

COMPATIBLE HOUSINGS ARE MARKED WITH "YES"

NON-COMPATIBLE HOUSINGS ARE HIGHLIGHTED IN RED

4 INCH HOUSINGS				
TRIMS	REMODEL		NEW CONSTRUCTION	
	R4-GUICRAT	R4-G19SRAT	R4-GUICAT	R4-G19SAT
R4-409	YES	YES	YES	YES
R4-421	YES	YES	YES	YES
R4-421TL-MW			YES	
R4-488	YES	YES	YES	YES
R4-488DG	YES	YES	YES	YES
R4-493	YES	YES	YES	YES
R4-508	YES	YES	YES	YES
R4-520	YES		YES	
R4-521	YES	YES	YES	YES
R4-545	YES		YES	
R4-549	YES		YES	
R4-5765	YES	YES	YES	YES
R4-579	YES		YES	
R4-587	YES		YES	
R4-588	YES	YES	YES	YES
R4-588DG	YES	YES	YES	YES
R4-589	YES	YES	YES	YES
R4-589TL-MW			YES	
R4-590	YES	YES	YES	YES
R4-593	YES	YES	YES	YES
R4-DR488	YES	YES	YES	YES
R4-DR88	YES	YES	YES	YES
R4-DS589	YES	YES	YES	YES
R4-DS88	YES	YES	YES	YES
R4-DS90	YES	YES	YES	YES
R4-DS90	YES	YES	YES	YES

WARRANTY & DISCLAIMER

- Beach Lighting will only warranty product sold from an authorized Beach Lighting dealer.
- All products depicted in this catalog, when properly installed, are ETL listed.
- Please consult dimmer compatibility page (pg.132) for dimming our LED lamps and consult factory before using any unlisted dimmers.
- If a lamp is used with a incompatible dimmer we assume no responsibility for any malfunctions that may occur and makes any remaining portion of the warranty void.
- The wave system can only be used with the specified wave dimming module, it cannot be used with a wall dimmer or any other dimmer. Use with an incompatible dimmer voids warranty.
- Beach Lighting reserves the right to make design changes or modifications without prior notification.
- All photos in this catalog are solely for examples of recessed lighting application.

WARRANTY- All trims and housings in this catalog are warranted to be free of defects in material and workmanship for (1) one year from the date of purchase. LED lamps as well as all parts of the LED Wave System are warranted for (3) three years. This warranty is limited to the correction of any such defect, or the replacement of any such defective item, provided that (a) item(s) were purchased from an authorized Beach Lighting distributor; in the event the item is discontinued we will provide a suitable replacement for the original lamp within two years, after two years to the end of the warranty, we will prorate and issue a credit towards the purchase of replacement (b) we are properly notified and customer consents to the return of the item(s) in question; (c) the item(s) are returned with proof of purchase date; and (d) we find that the item(s) are defective in such a way covered by the warranty stated above. This warranty does not cover labor costs or consequential damages, nor does it apply to any item(s) that have been improperly installed, overloaded, altered, used with improper dimmer or otherwise abused by customer, its agent(s) or employee(s).

Product specifications and designs are subject to change at any time.

GENERAL CONDITIONS- Beach Lighting may cease selling product to any dealer that sells or distributes to an unauthorized dealer for resale purposes. Beach Lighting reserves the right to void the warranty on any product that does not meet the criteria listed above.

