

Standardised “EN 733” centrifugal pumps

 Clean water

 Industrial use



PERFORMANCE RANGE

- Flow rate up to **3000 l/min** (180 m³/h)
- Head up to **24 m**

APPLICATION LIMITS

- Manometric suction lift up to **7 m**
- Liquid temperature between **-10 °C** and **+90 °C**
- Ambient temperature between **-10 °C** and **+40 °C**
- Max. pressure in pump body **10 bar** (PN10)
- Continuous service **S1**

CONSTRUCTION AND SAFETY STANDARDS

EN 60335-1
IEC 60335-1
CEI 61-150

EN 60034-1
IEC 60034-1
CEI 2-3



Pump body dimensions in compliance with **EN 733**
EU REGULATION N. 547/2012

INSTALLATION AND USE

- Water supply
- Pressure boosting
- Irrigation
- Water circulation in air-conditioning units
- Cleaning sets
- Firefighting sets
- Industrial applications
- Agricultural applications

The pump should be installed in an enclosed environment or sheltered from inclement weather.

OPTIONS AVAILABLE ON REQUEST

- Counter flange KIT complete with bolts, nuts and washers
- Other voltages or 60 Hz frequency
- Compatibility with hotter or colder liquids
- Compatibility with hotter or colder environments

CERTIFICATIONS

Company with management system certified DNV
ISO 9001: QUALITY
ISO 14001: ENVIRONMENT AND SAFETY



PERFORMANCE RANGE

50 Hz n = 1450 rpm

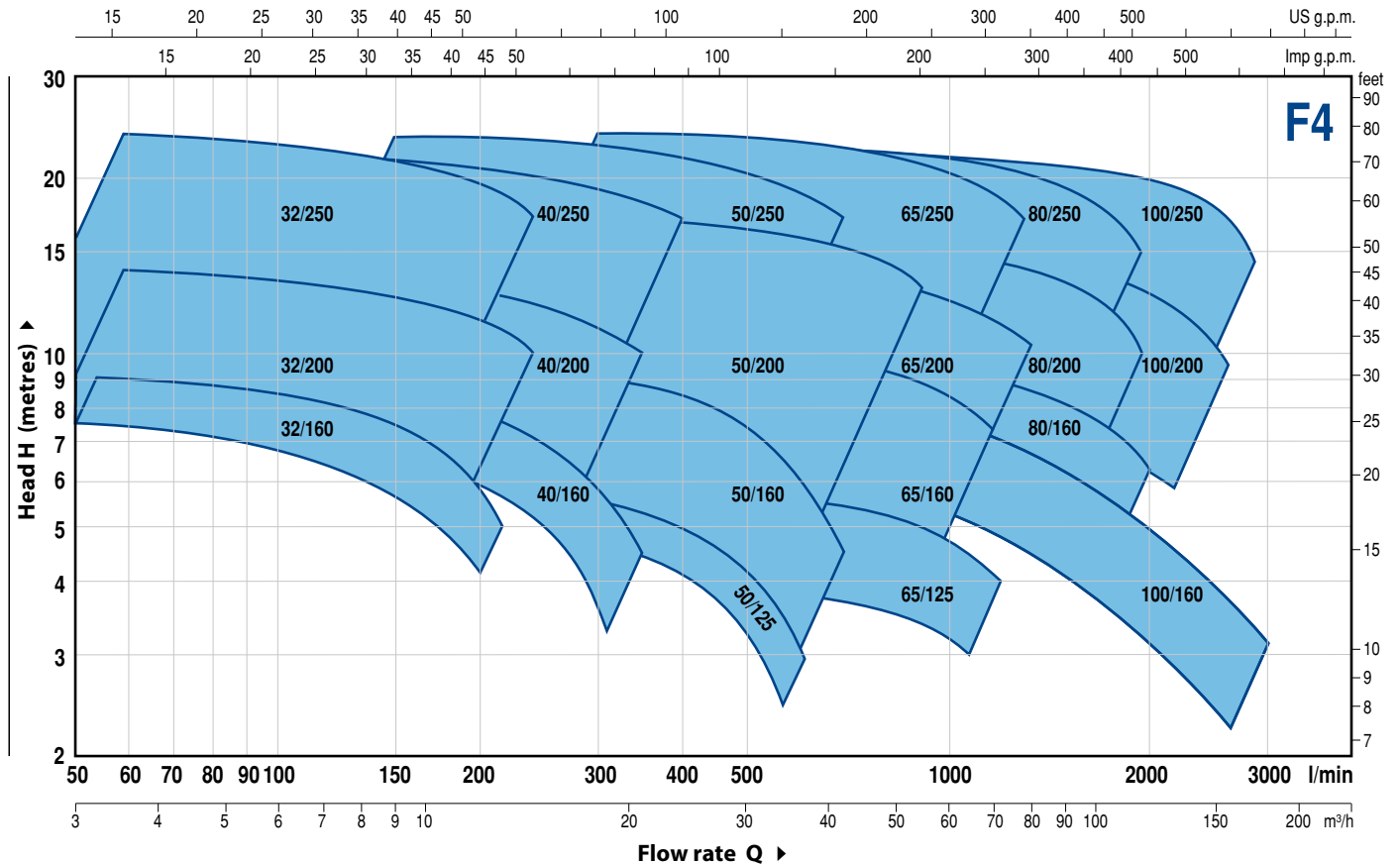

PERFORMANCE DATA

50 Hz n = 1450 rpm

MODEL	POWER (P ₂)			PERFORMANCE	
	Three-phase	kW	HP ▲	Q l/min	H metres
F4-32/160B	0.37	0.5	IE2	50 ÷ 200	7.5 ÷ 4.5
F4-32/160A	0.37	0.5		50 ÷ 225	9 ÷ 5
F4-32/200B	0.75	1	IE2	50 ÷ 250	12.5 ÷ 9
F4-32/200A	1.1	1.5		50 ÷ 250	14 ÷ 10.5
F4-32/200BH	0.75	1	IE2	50 ÷ 150	11.3 ÷ 9.2
F4-32/200AH	0.75	1		50 ÷ 160	13.8 ÷ 11
F4-32-250C	1.1	1.5	IE2	50 ÷ 200	18.5 ÷ 13.5
F4-32-250B	1.5	2		50 ÷ 225	21.5 ÷ 15.5
F4-32-250A	2.2	3	IE3	50 ÷ 250	24 ÷ 16.5
F4-40/160B	0.37	0.5	IE2	50 ÷ 320	7.5 ÷ 3.5
F4-40/160A	0.55	0.75		50 ÷ 350	9 ÷ 4.5
F4-40/200B	0.75	1	IE2	50 ÷ 350	11.5 ÷ 7
F4-40/200A	1.1	1.5		50 ÷ 350	13.8 ÷ 10
F4-40/250C	1.1	1.5	IE2	50 ÷ 400	15.5 ÷ 10
F4-40/250B	1.5	2		50 ÷ 400	17.5 ÷ 12
F4-40/250A	2.2	3	IE3	50 ÷ 400	22 ÷ 17
F4-50/125B	0.55	0.75	IE2	150 ÷ 600	5 ÷ 2
F4-50/125A	0.55	0.75		150 ÷ 600	6 ÷ 3
F4-50/160B	0.75	1	IE2	150 ÷ 650	8 ÷ 3.8
F4-50/160A	1.1	1.5		150 ÷ 700	9.3 ÷ 4.5
F4-50/200C	1.5	2	IE3	200 ÷ 850	11 ÷ 7.5
F4-50/200B	2.2	3		200 ÷ 850	13 ÷ 9.5
F4-50/200A	2.2	3		200 ÷ 900	15 ÷ 11.2
F4-50/200AR	3	4		200 ÷ 900	17 ÷ 13.2
F4-50/250D	1.1	1.5	IE2	150 ÷ 650	12.5 ÷ 5
F4-50/250C	1.5	2		150 ÷ 700	14 ÷ 5
F4-50/250B	2.2	3		150 ÷ 700	18 ÷ 10.5
F4-50/250A	2.2	3		150 ÷ 700	20 ÷ 13
F4-50/250AR	3	4		150 ÷ 700	23.5 ÷ 17

MODEL	POWER (P ₂)			PERFORMANCE	
	Three-phase	kW	HP ▲	Q l/min	H metres
F4-65/125B	0.75	1	IE2	300 ÷ 1100	4.7 ÷ 3
F4-65/125A	1.1	1.5		300 ÷ 1200	5.7 ÷ 4
F4-65/160C	1.1	1.5	IE2	300 ÷ 1100	8 ÷ 5.5
F4-65/160B	1.5	2		300 ÷ 1200	9.1 ÷ 5.7
F4-65/160A	2.2	3	IE3	300 ÷ 1200	10.1 ÷ 7
F4-65/200A	2.2	3		300 ÷ 1250	12 ÷ 8.5
F4-65/200AR	3	4	IE3	300 ÷ 1300	14 ÷ 10
F4-65/250B	4	5.5	IE3	200 ÷ 1250	21.8 ÷ 15.5
F4-65/250A	5.5	7.5		200 ÷ 1300	23.5 ÷ 17
F4-80/160D	1.5	2	IE3	300 ÷ 2000	6.3 ÷ 2.5
F4-80/160C	2.2	3		300 ÷ 2000	7.5 ÷ 3.8
F4-80/160B	2.2	3		300 ÷ 2000	8.8 ÷ 5
F4-80/160A	3	4		300 ÷ 2000	10 ÷ 6.2
F4-80/200B	4	5.5	IE3	300 ÷ 1800	14 ÷ 9
F4-80/200A	5.5	7.5		300 ÷ 1900	15.5 ÷ 10.5
F4-80/250B	5.5	7.5	IE3	300 ÷ 1800	19.5 ÷ 13.5
F4-80/250A	7.5	10		300 ÷ 1950	22 ÷ 15
F4-100/160B-N	2.2	3	IE3	400 ÷ 2750	8.1 ÷ 2.7
F4-100/160A-N	3	4		400 ÷ 3000	9.2 ÷ 3.2
F4-100/200C	4	5.5	IE3	400 ÷ 2300	12.7 ÷ 7
F4-100/200B	5.5	7.5		400 ÷ 2400	14.2 ÷ 8.5
F4-100/200A	5.5	7.5		400 ÷ 2600	15.8 ÷ 9.5
F4-100/250B	7.5	10	IE3	400 ÷ 2600	18.5 ÷ 11.5
F4-100/250A	9.2	12.5		400 ÷ 2900	22 ÷ 13.5

Q = Flow rate

H = Total manometric head

Tolerance of characteristic curves in compliance with EN ISO 9906 Grade 3B.

▲ Performance class of the three-phase motor (IEC-60034-30)

F4-32/160

CHARACTERISTIC CURVES AND PERFORMANCE DATA

50 Hz n= 1450 rpm HS= 0 m

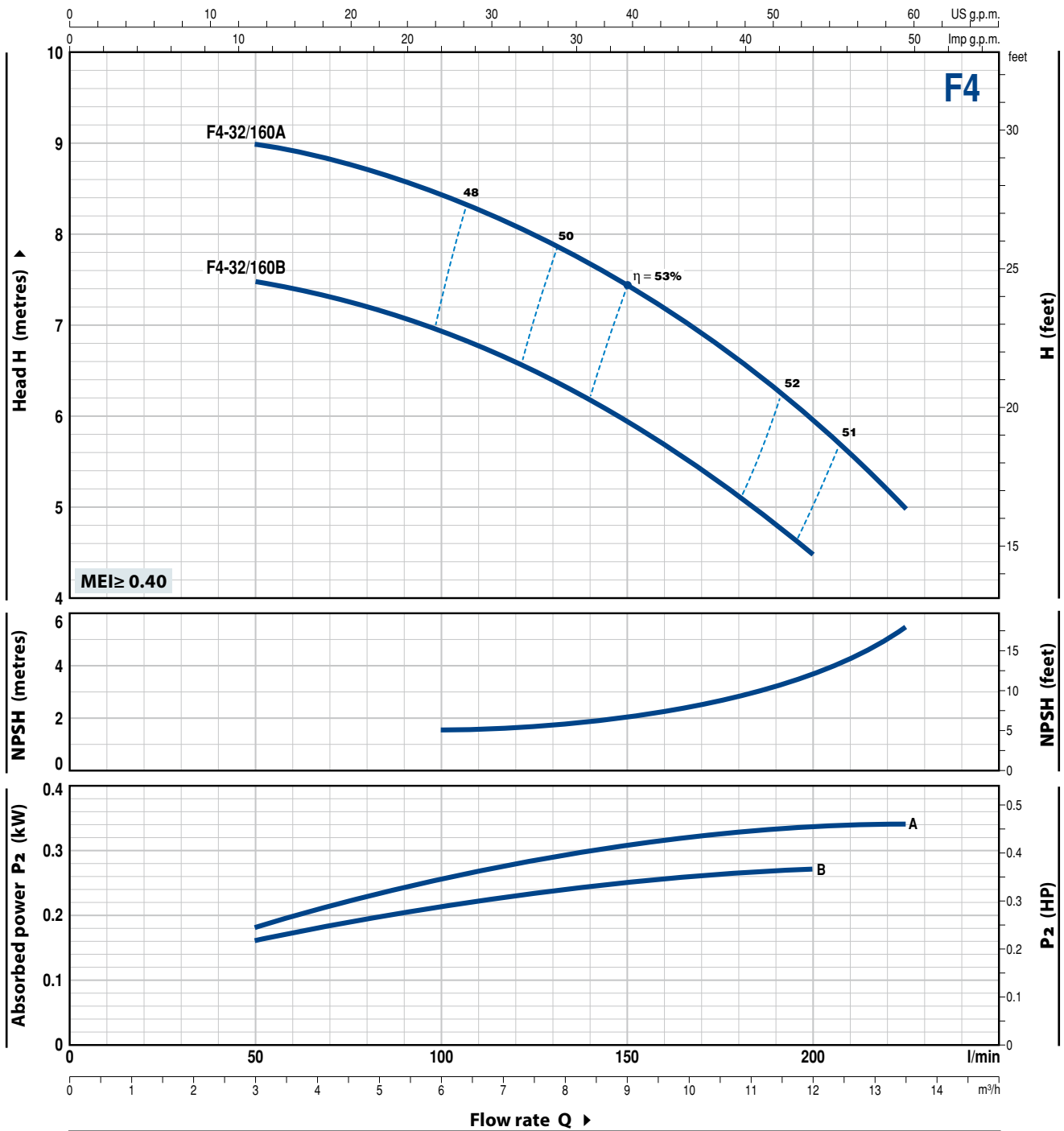

MODEL	POWER (P ₂)		Q	Flow rate								
	kW	HP		m ³ /h	3	4.5	6	7.5	9	10.8	12	13.5
Three-phase			l/min	50	75	100	125	150	180	200	225	
F4-32/160B	0.37	0.5	H metres	7.5	7.3	6.9	6.5	6	5.1	4.5		
F4-32/160A	0.37	0.5		9	8.8	8.4	8	7.5	6.6	6	5	

Q = Flow rate H = Total manometric head HS = Suction height

Tolerance of characteristic curves in compliance with EN ISO 9906 Grade 3B.

CHARACTERISTIC CURVES AND PERFORMANCE DATA

50 Hz n= 1450 rpm HS= 0 m

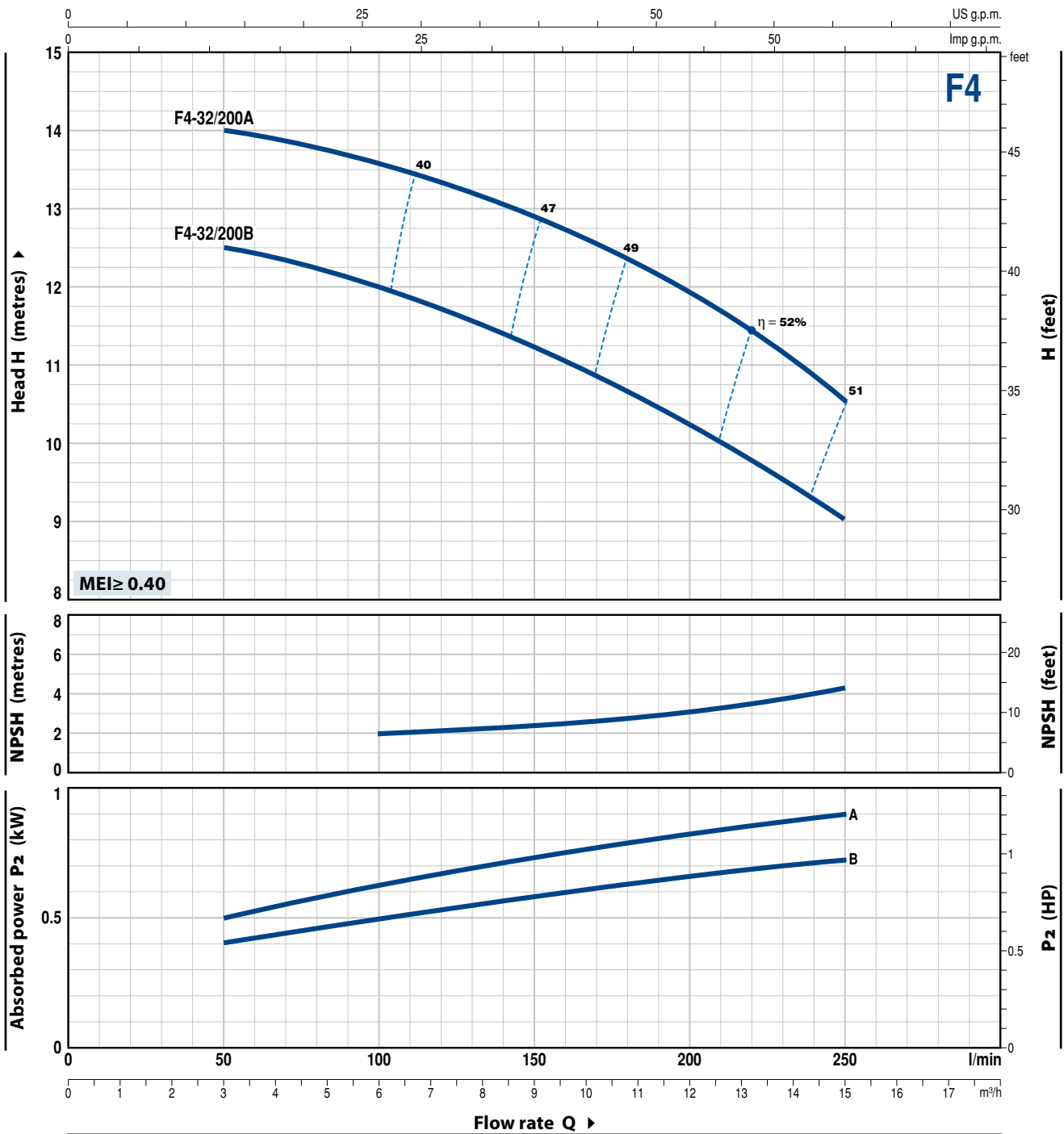

MODEL	POWER (P ₂)		Q	Flow rate				
	kW	HP		m ³ /h	l/min	l/min	l/min	l/min
Three-phase				3	6	9	12	15
				50	100	150	200	250
F4-32/200B	0.75	1	H metres	12.5	12	11.2	10.3	9
F4-32/200A	1.1	1.5	H metres	14	13,6	12.8	11.9	10.5

Q = Flow rate H = Total manometric head HS = Suction height

Tolerance of characteristic curves in compliance with EN ISO 9906 Grade 3B.

F4-32/200H

CHARACTERISTIC CURVES AND PERFORMANCE DATA

50 Hz n= 1450 rpm HS= 0 m

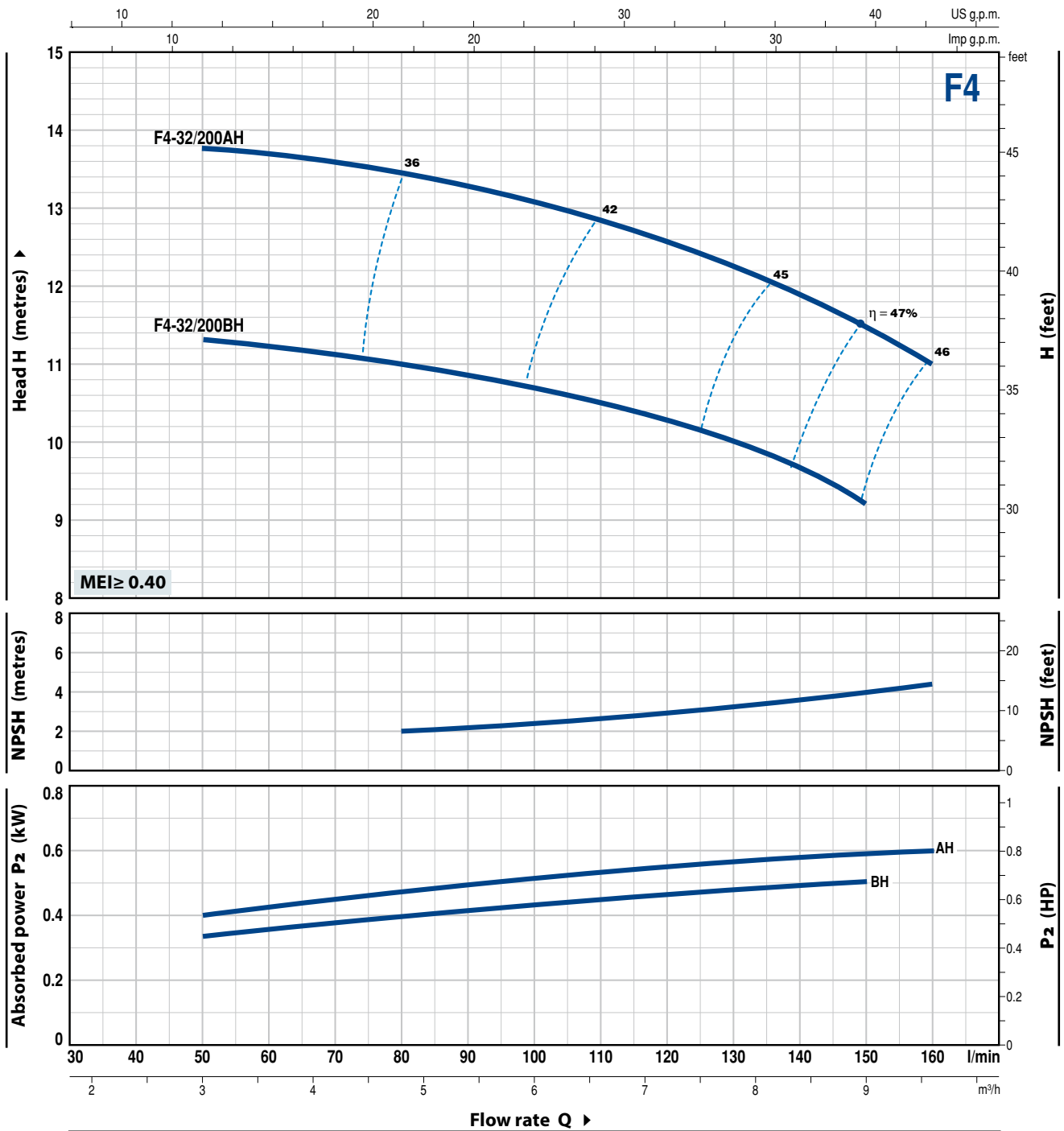

MODEL	POWER (P ₂)		Q	Flow rate							
	kW	HP		m ³ /h	3	4.2	5.4	6.6	7.8	9	9.6
Three-phase				50	70	90	110	130	150	160	
F4-32/200BH	0.75	1	H metres	11.3	11.1	10.8	10.5	10	9.2		
F4-32/200AH	0.75	1	H metres	13.8	13.6	13.3	12.8	12.2	11.5	11	

Q = Flow rate H = Total manometric head HS = Suction height

Tolerance of characteristic curves in compliance with EN ISO 9906 Grade 3B.

CHARACTERISTIC CURVES AND PERFORMANCE DATA

50 Hz n= 1450 rpm HS= 0 m

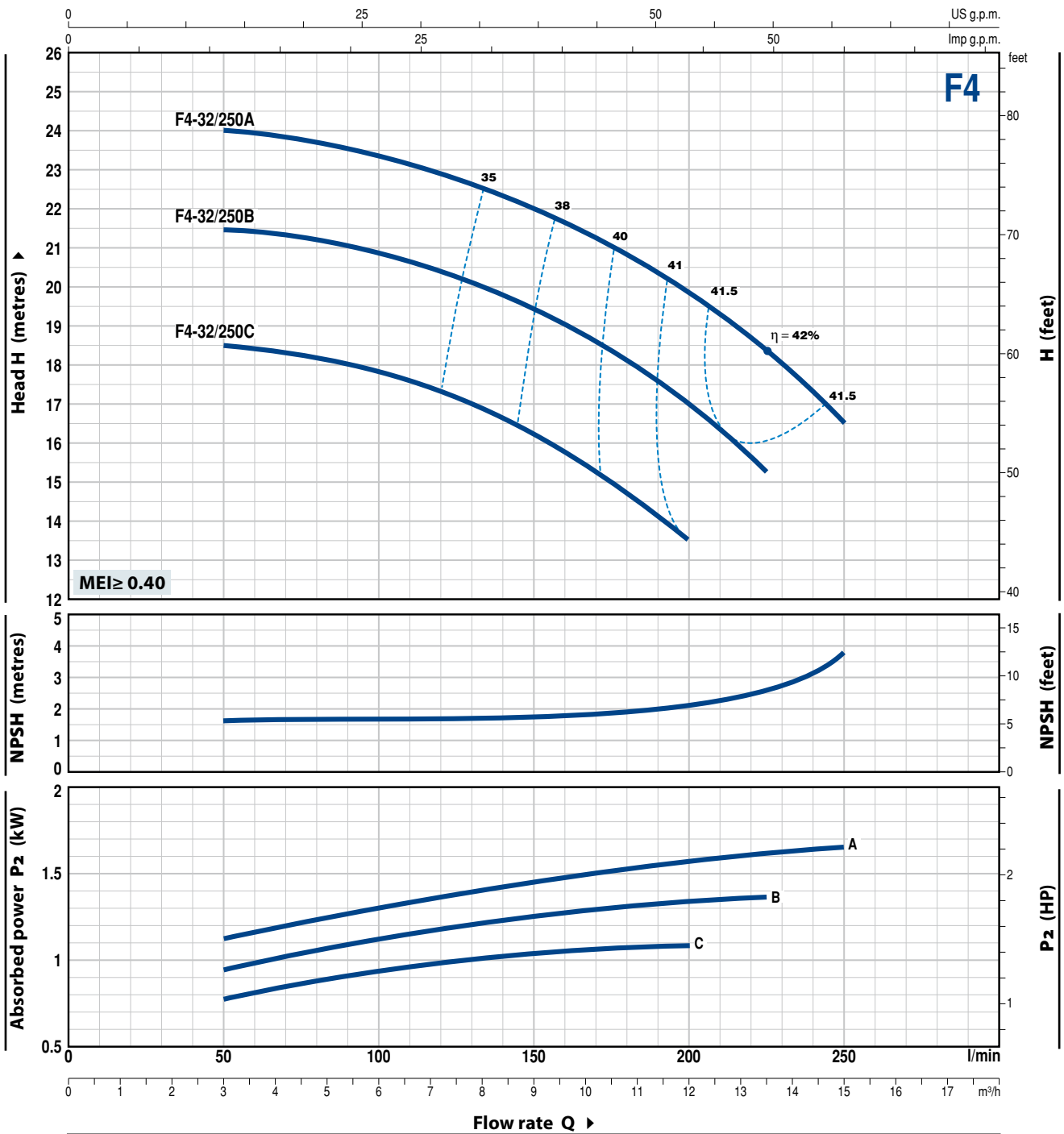

MODEL	POWER (P ₂)		Q	Flow rate											
	kW	HP		m ³ /h	3	4.5	6	7.5	9	10.5	12	13.5	15		
Three-phase			l/min	50	75	100	125	150	175	200	225	250			
F4-32/250C	1.1	1.5	H metres		18.5	18.2	17.8	17.2	16.2	15	13.5				
F4-32/250B	1.5	2			21.5	21.2	20.8	20.2	19.5	18.2	17	15.5			
F4-32/250A	2.2	3			24	23.7	23.3	22.7	22	21	19.8	18.3	16.5		

Q = Flow rate H = Total manometric head HS = Suction height

Tolerance of characteristic curves in compliance with EN ISO 9906 Grade 3B.

F4-40/160

CHARACTERISTIC CURVES AND PERFORMANCE DATA

50 Hz n= 1450 rpm HS= 0 m

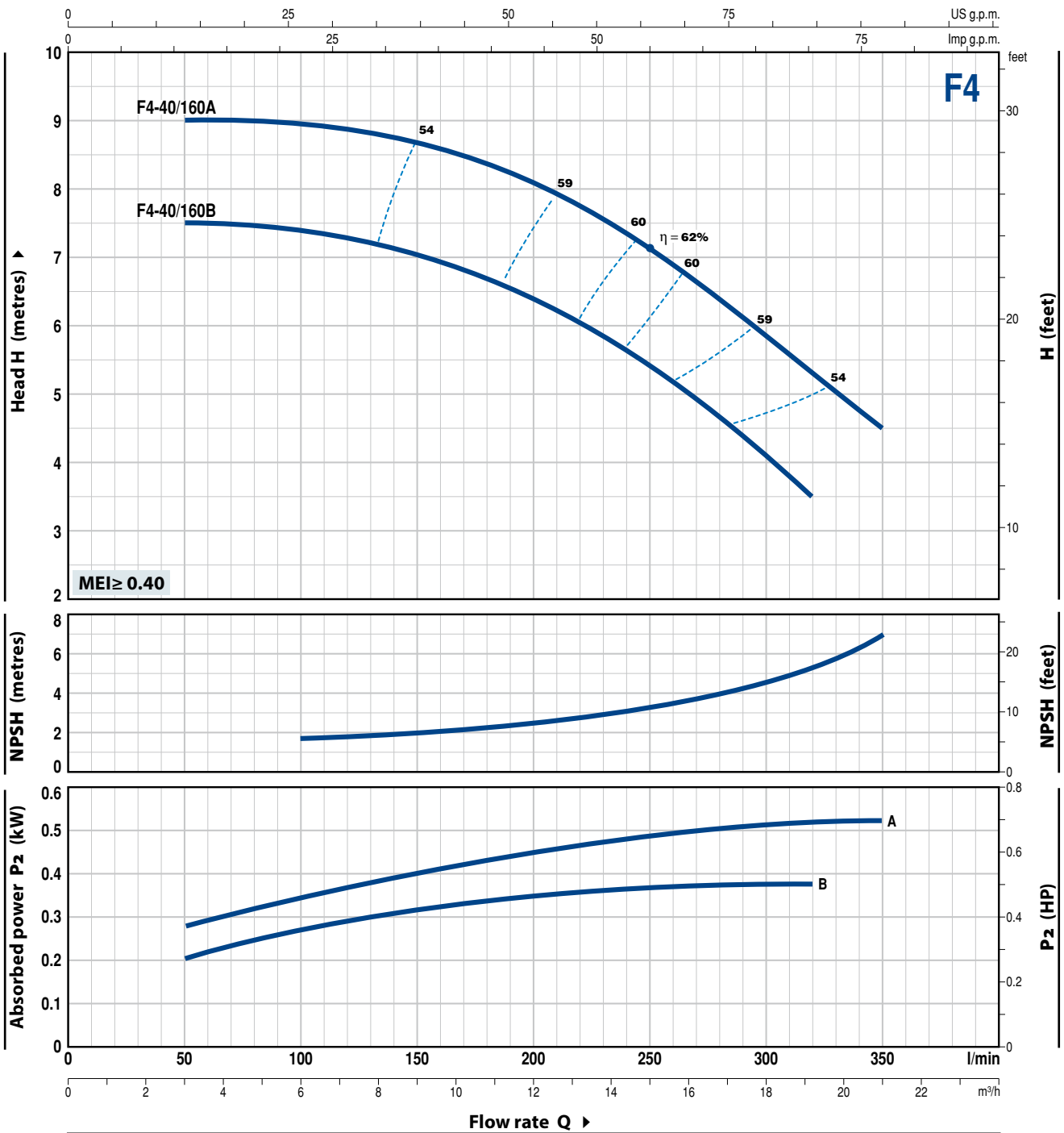

MODEL	POWER (P ₂)		Q	Flow rate									
	kW	HP		m ³ /h	l/min	3	6	9	12	15	18	19.2	21
Three-phase				50	100	150	200	250	300	320	350		
F4-40/160B	0.37	0.5	H metres	7.5	7.4	7	6.4	5.4	4.1	3.5			
F4-40/160A	0.55	0.75		9	8.9	8.7	8.1	7.1	5.8	5.3	4.5		

Q = Flow rate H = Total manometric head HS = Suction height

Tolerance of characteristic curves in compliance with EN ISO 9906 Grade 3B.

CHARACTERISTIC CURVES AND PERFORMANCE DATA

50 Hz n= 1450 rpm HS= 0 m

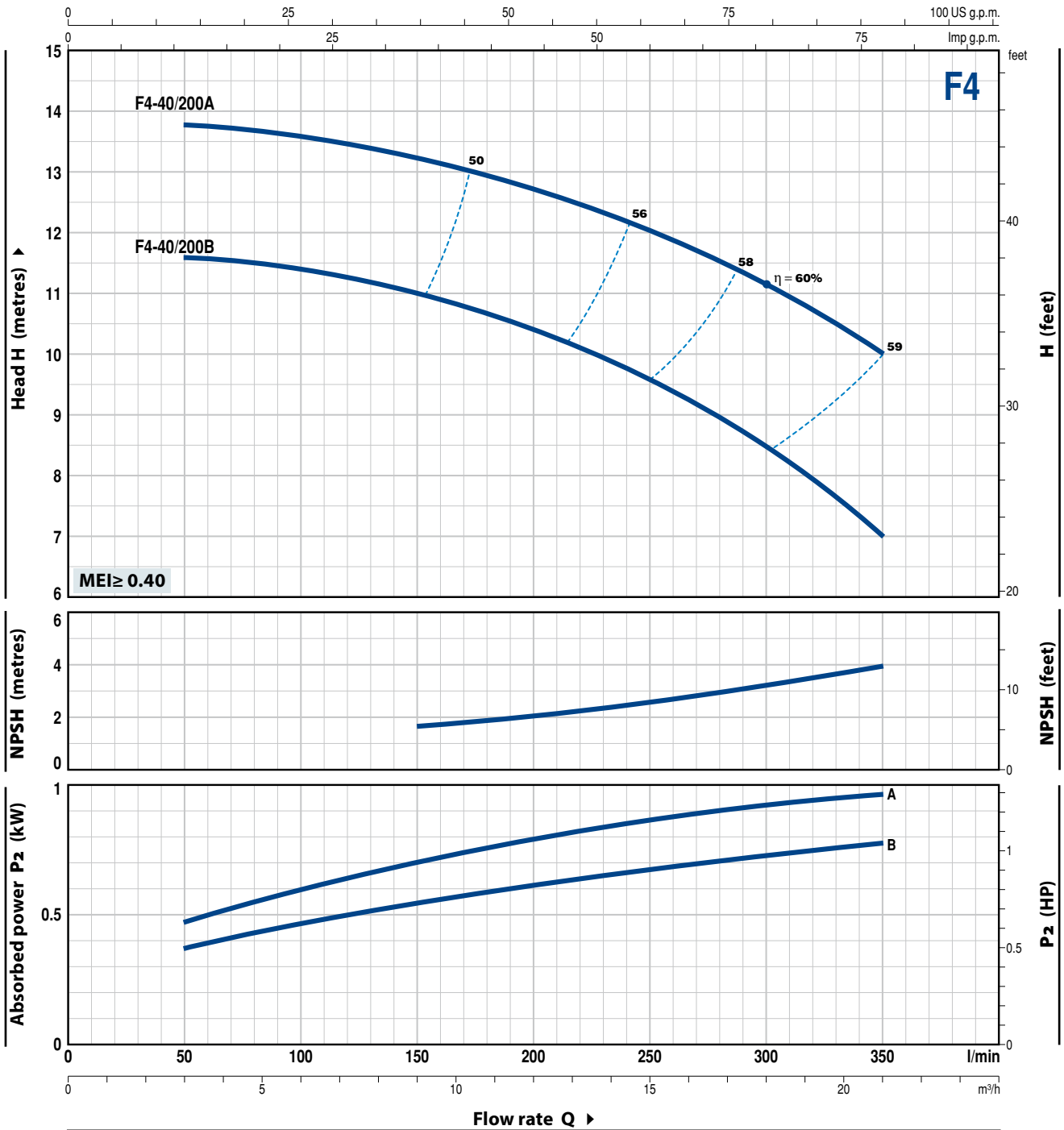

MODEL	POWER (P ₂)		Q	3	6	9	12	15	18	21
	kW	HP		l/min	50	100	150	200	250	300
F4-40/200B	0.75	1	H metres	11.5	11.4	11	10.4	9.5	8.5	7
F4-40/200A	1.1	1.5	H metres	13.8	13.6	13.2	12.7	12	11.1	10

Q = Flow rate H = Total manometric head HS = Suction height

Tolerance of characteristic curves in compliance with EN ISO 9906 Grade 3B.

F4-40/250

CHARACTERISTIC CURVES AND PERFORMANCE DATA

50 Hz n= 1450 rpm HS= 0 m

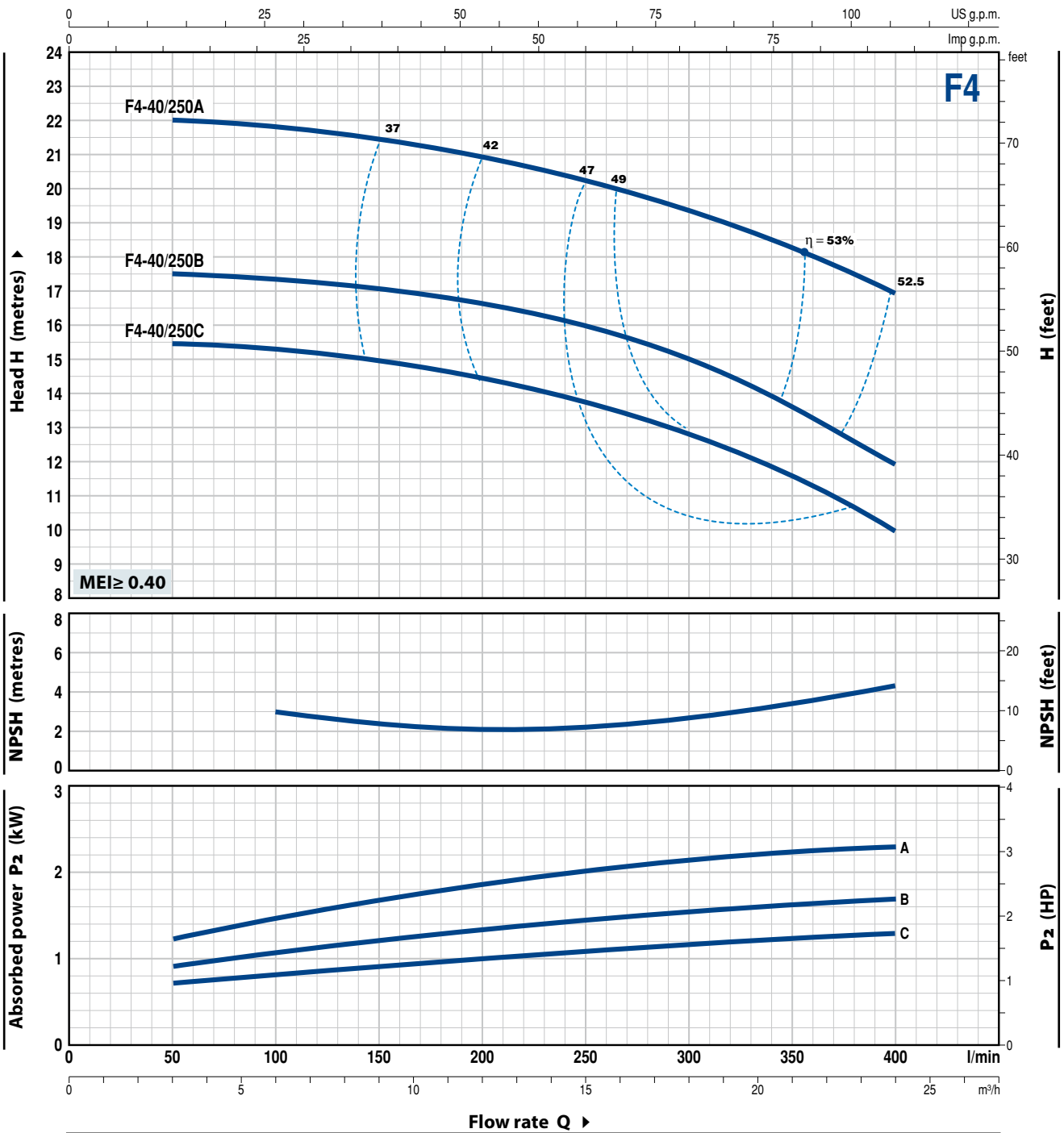

MODEL	POWER (P_2)		Q	3	6	9	12	15	18	21	24
	kW	HP		m^3/h	50	100	150	200	250	300	350
Three-phase			l/min								
F4-40/250C	1.1	1.5	H metres	15.5	15.2	15	14.5	13.6	12.9	11.5	10
F4-40/250B	1.5	2		17.5	17.2	17	16.5	16	15	13.5	12
F4-40/250A	2.2	3		22	21.9	21.5	21	20.2	19.2	18.2	17

Q = Flow rate H = Total manometric head HS = Suction height

Tolerance of characteristic curves in compliance with EN ISO 9906 Grade 3B.

CHARACTERISTIC CURVES AND PERFORMANCE DATA

50 Hz n = 1450 rpm HS = 0 m

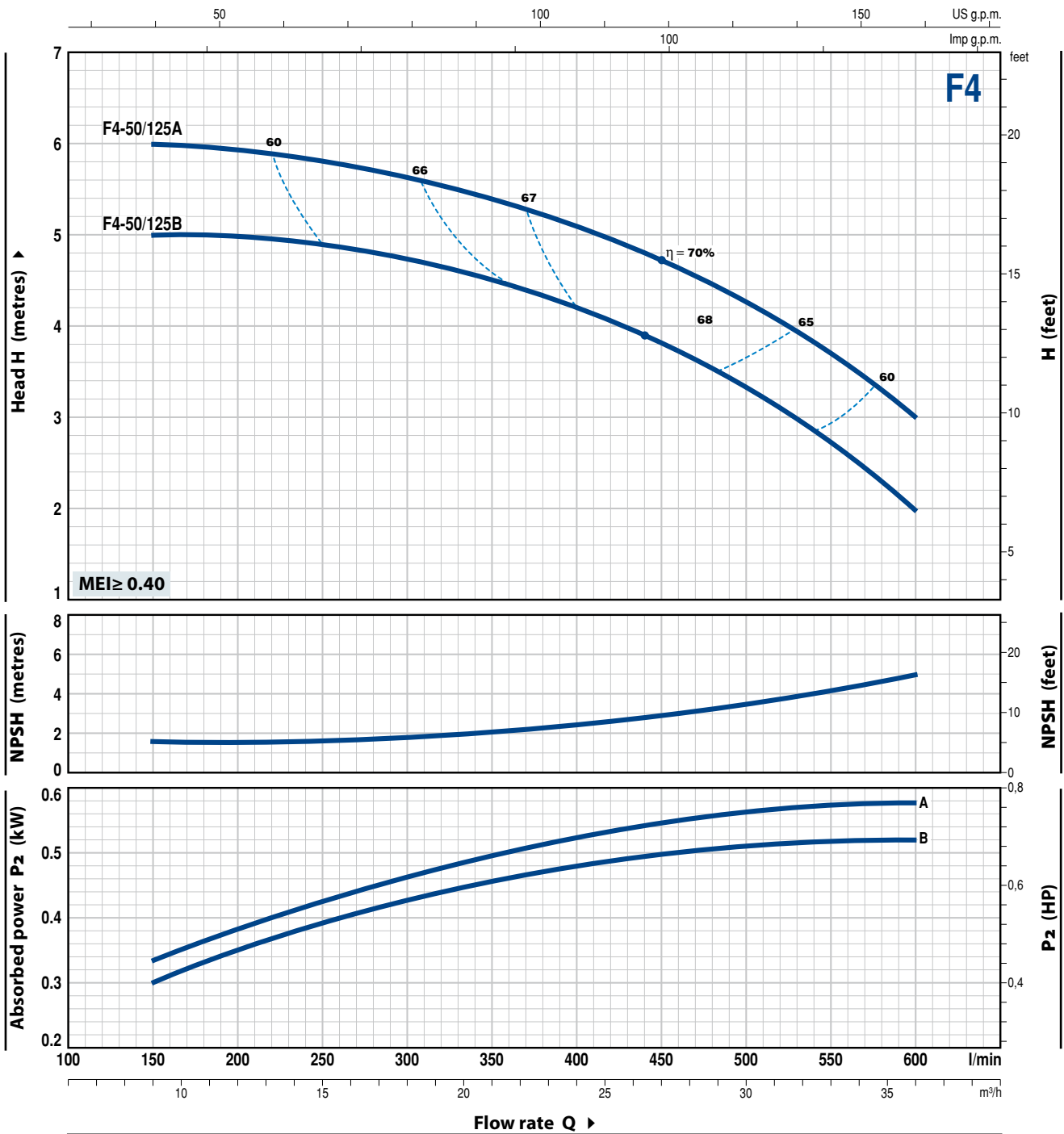

MODEL	POWER (P ₂)		Q	Flow rate											
	kW	HP		m ³ /h	9	12	15	17	21	24	27	30	33	36	
Three-phase			l/min	150	200	250	300	350	400	450	500	550	600		
F4-50/125B	0.55	0.75	H metres	5	5	4.9	4.7	4.5	4.2	3.8	3.3	2.7	2		
F4-50/125A	0.55	0.75		6	5.9	5.8	5.6	5.4	5.1	4.7	4.2	3.7	3		

Q = Flow rate H = Total manometric head HS = Suction height

Tolerance of characteristic curves in compliance with EN ISO 9906 Grade 3B.

F4-50/160

CHARACTERISTIC CURVES AND PERFORMANCE DATA

50 Hz n= 1450 rpm HS= 0 m

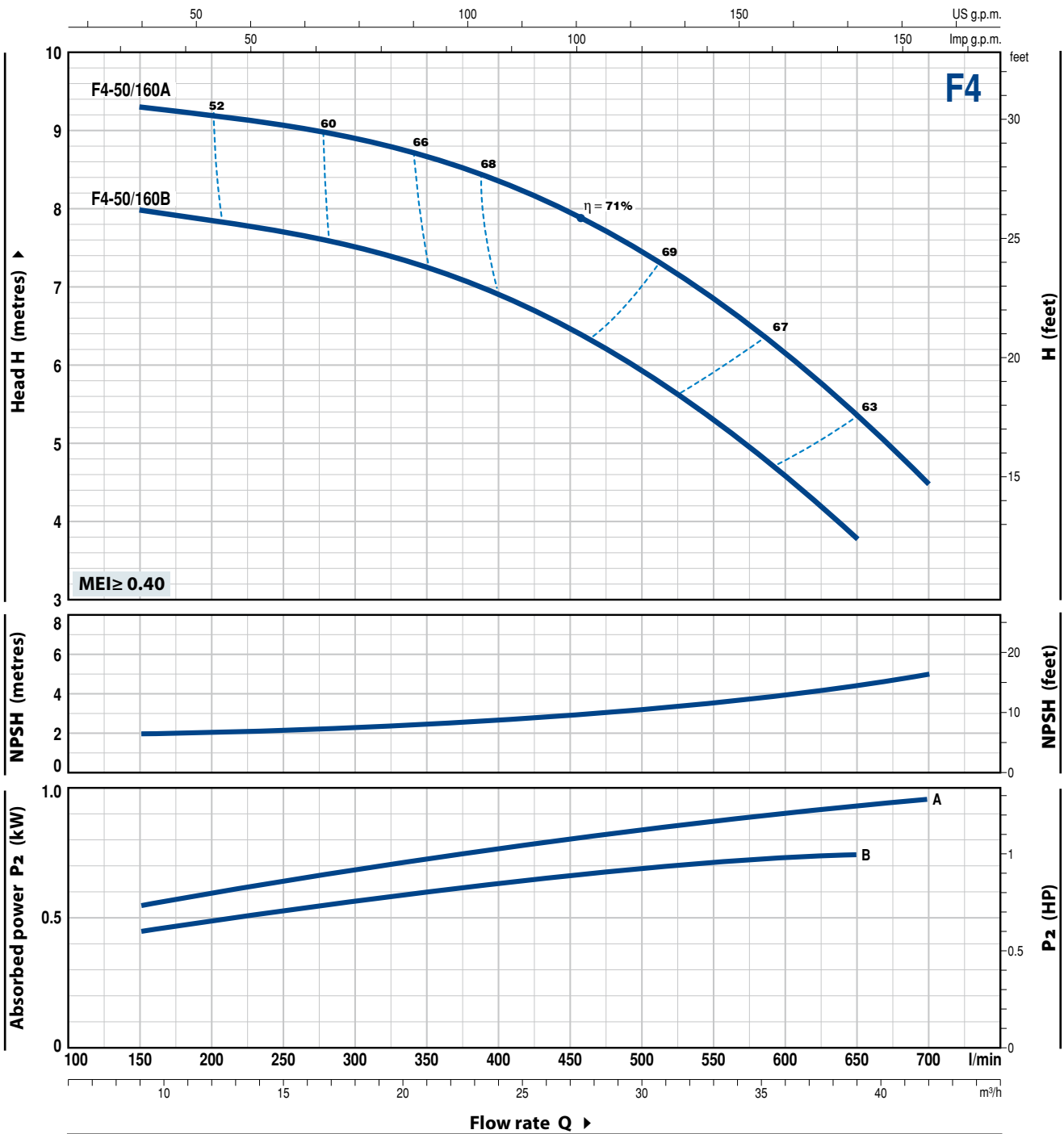

MODEL	POWER (P_2)		Q	Flow rate													
	kW	HP		m ³ /h	9	12	15	17	21	24	27	30	33	36	39	42	
Three-phase			l/min	150	200	250	300	350	400	450	500	550	600	650	700		
F4-50/160B	0.75	1	H metres	8	7.8	7.7	7.5	7.2	6.9	6.5	5.9	5.3	4.6	3.8			
F4-50/160A	1.1	1.5		9.3	9.2	9.1	8.9	8.7	8.4	8	7.4	6.8	6.2	5.4	4.5		

Q = Flow rate H = Total manometric head HS = Suction height

Tolerance of characteristic curves in compliance with EN ISO 9906 Grade 3B.

CHARACTERISTIC CURVES AND PERFORMANCE DATA

50 Hz n= 1450 rpm HS= 0 m

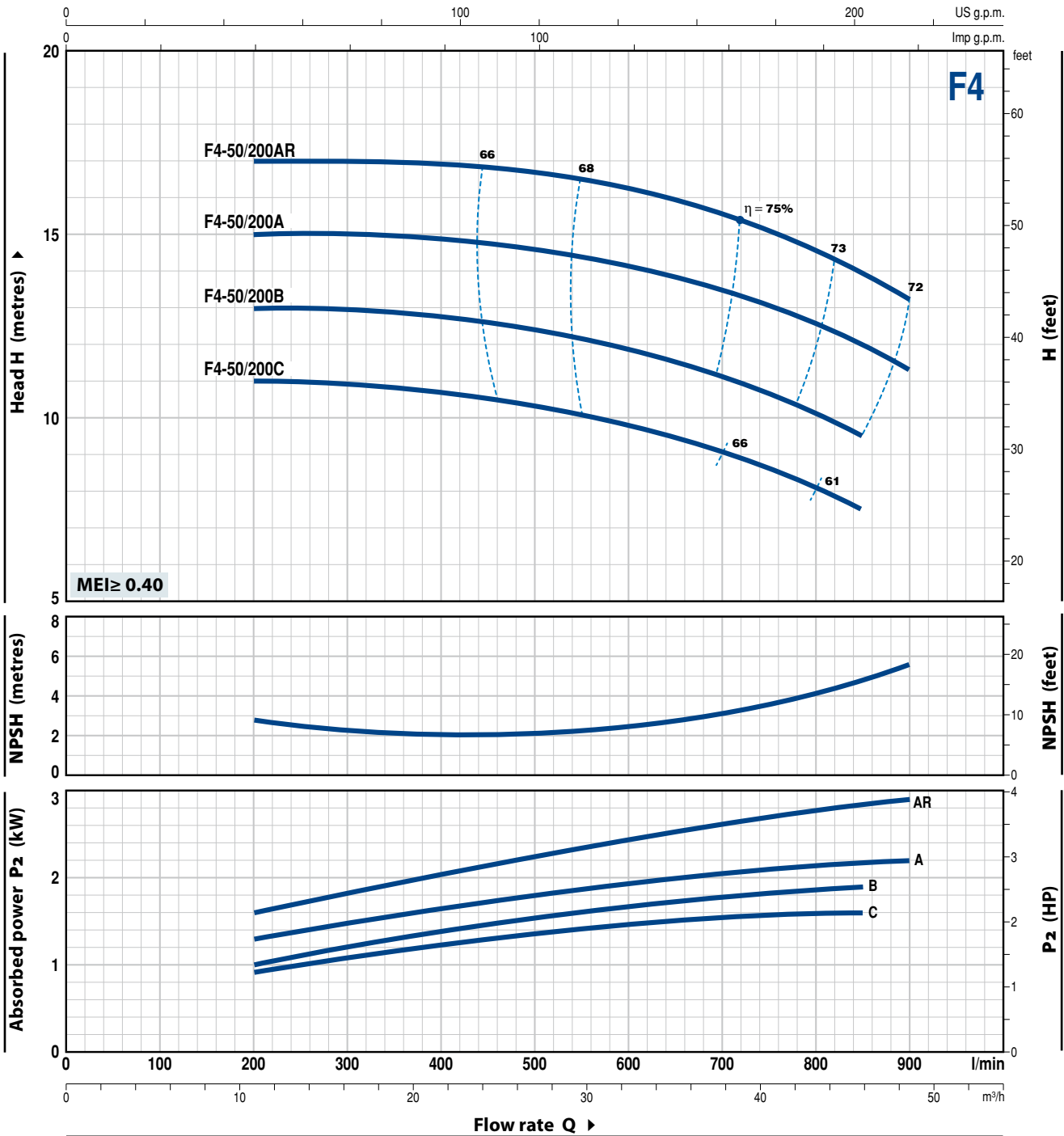

MODEL	POWER (P ₂)		Q	Flow rate											
	kW	HP		m ³ /h	12	17	24	30	36	42	48	51	54		
Three-phase			l/min	200	300	400	500	600	700	800	850	900			
F4-50/200C	1.5	2	H metres	11	11	10.8	10.3	9.8	9	8	7.5				
F4-50/200B	2.2	3		13	13	12.8	12.4	11.9	11.1	10.1	9.5				
F4-50/200A	2.2	3		15	15	14.9	14.6	14.1	13.5	12.5	12	11.2			
F4-50/200AR	3	4		17	17	16.9	16.7	16.2	15.5	14.5	14	13.2			

Q = Flow rate H = Total manometric head HS = Suction height

Tolerance of characteristic curves in compliance with EN ISO 9906 Grade 3B.

F4-50/250

CHARACTERISTIC CURVES AND PERFORMANCE DATA

50 Hz n= 1450 rpm HS= 0 m

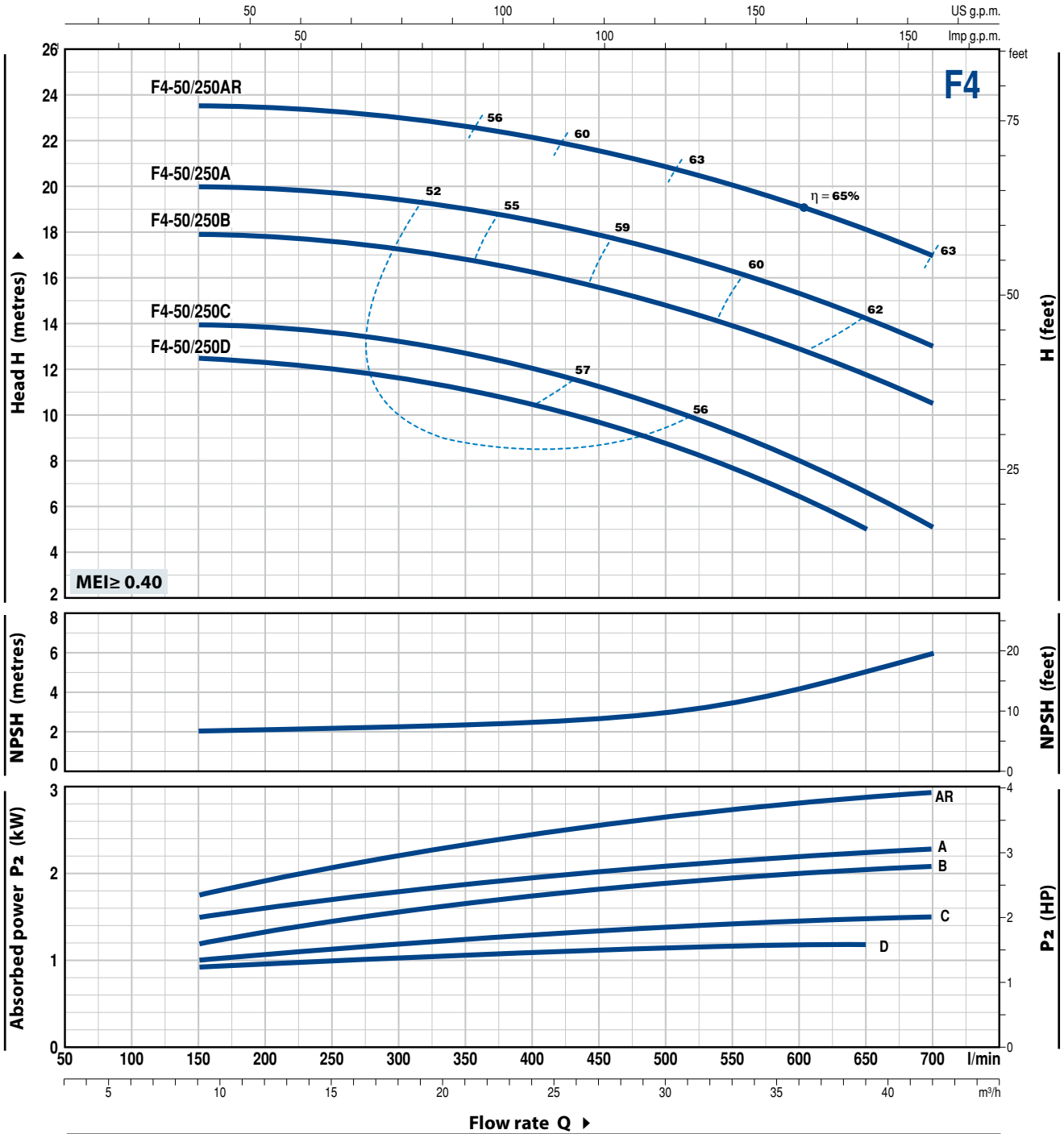

MODEL	POWER (P ₂)		Q	Flow rate													
	kW	HP		m ³ /h	9	12	15	18	21	24	27	30	33	36	39	42	
Three-phase			l/min	150	200	250	300	350	400	450	500	550	600	650	700		
F4-50/250D	1.1	1.5	H metres	12.5	12.3	12	11.5	11.1	10.5	9.8	8.8	7.8	6.5	5			
F4-50/250C	1.5	2		14	13.9	13.6	13.2	12.8	12	11.2	10.2	9.2	8	6.6	5		
F4-50/250B	2.2	3		18	17.9	17.6	17.2	16.8	16.2	15.5	14.8	14	13	11.8	10.5		
F4-50/250A	2.2	3		20	19.9	19.7	19.5	19	18.5	18	17.2	16.2	15.3	14.2	13		
F4-50/250AR	3	4		23.5	23.4	23.2	23	22.6	22.1	21.6	21	20	19	18	17		

Q = Flow rate H = Total manometric head HS = Suction height

Tolerance of characteristic curves in compliance with EN ISO 9906 Grade 3B.

CHARACTERISTIC CURVES AND PERFORMANCE DATA

50 Hz n= 1450 rpm HS= 0 m

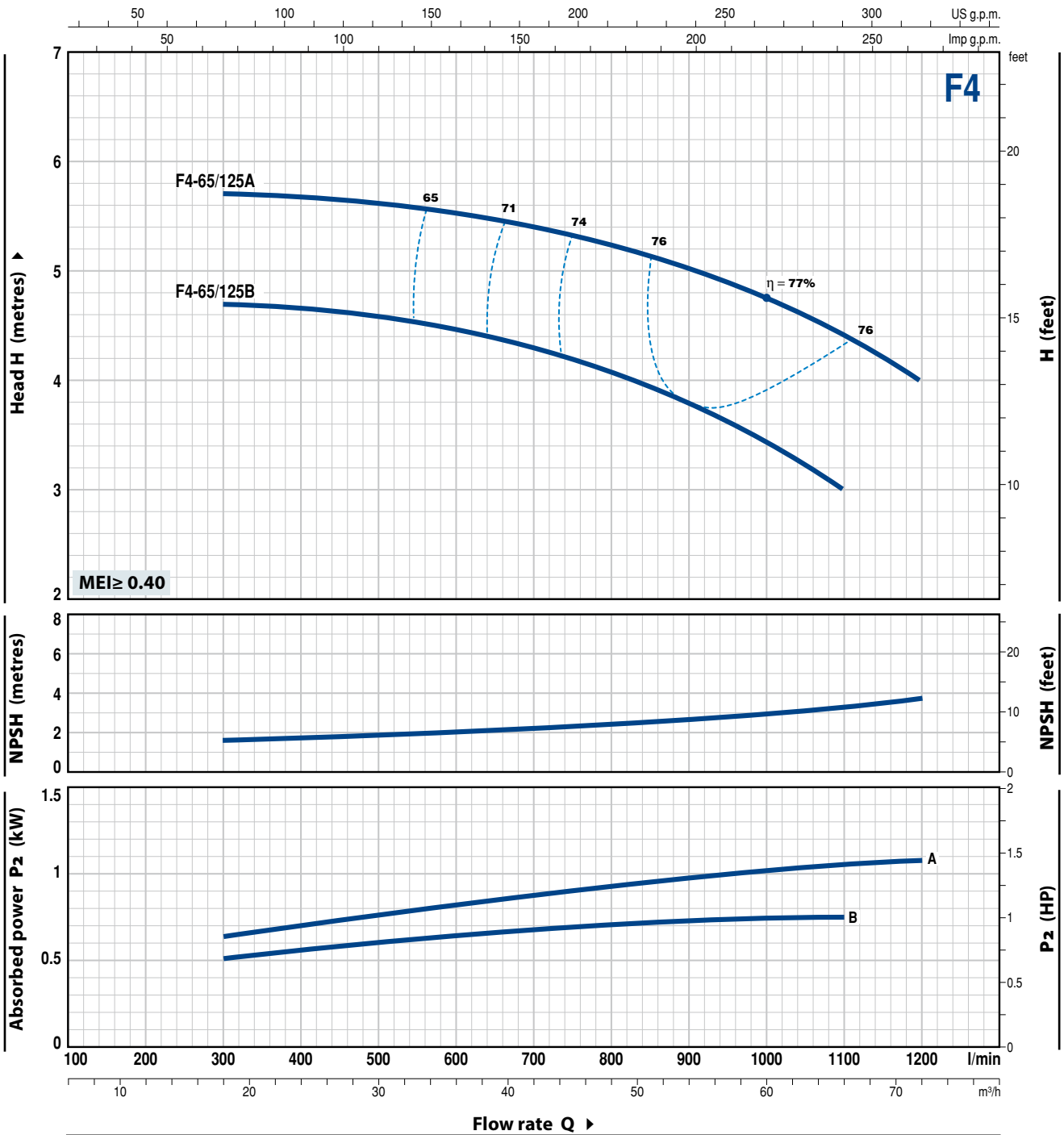

MODEL	POWER (P ₂)		Q	Flow rate											
	kW	HP		m ³ /h	18	24	30	36	42	48	54	60	66	72	
Three-phase			l/min	300	400	500	600	700	800	900	1000	1100	1200		
F4-65/125B	0.75	1	H metres	4.7	4.7	4.6	4.5	4.3	4.1	3.8	3.4	3			
F4-65/125A	1.1	1.5		5.7	5.7	5.6	5.5	5.4	5.2	5	4.7	4.4	4		

Q = Flow rate H = Total manometric head HS = Suction height

Tolerance of characteristic curves in compliance with EN ISO 9906 Grade 3B.

F4-65/160

CHARACTERISTIC CURVES AND PERFORMANCE DATA

50 Hz n= 1450 rpm HS= 0 m

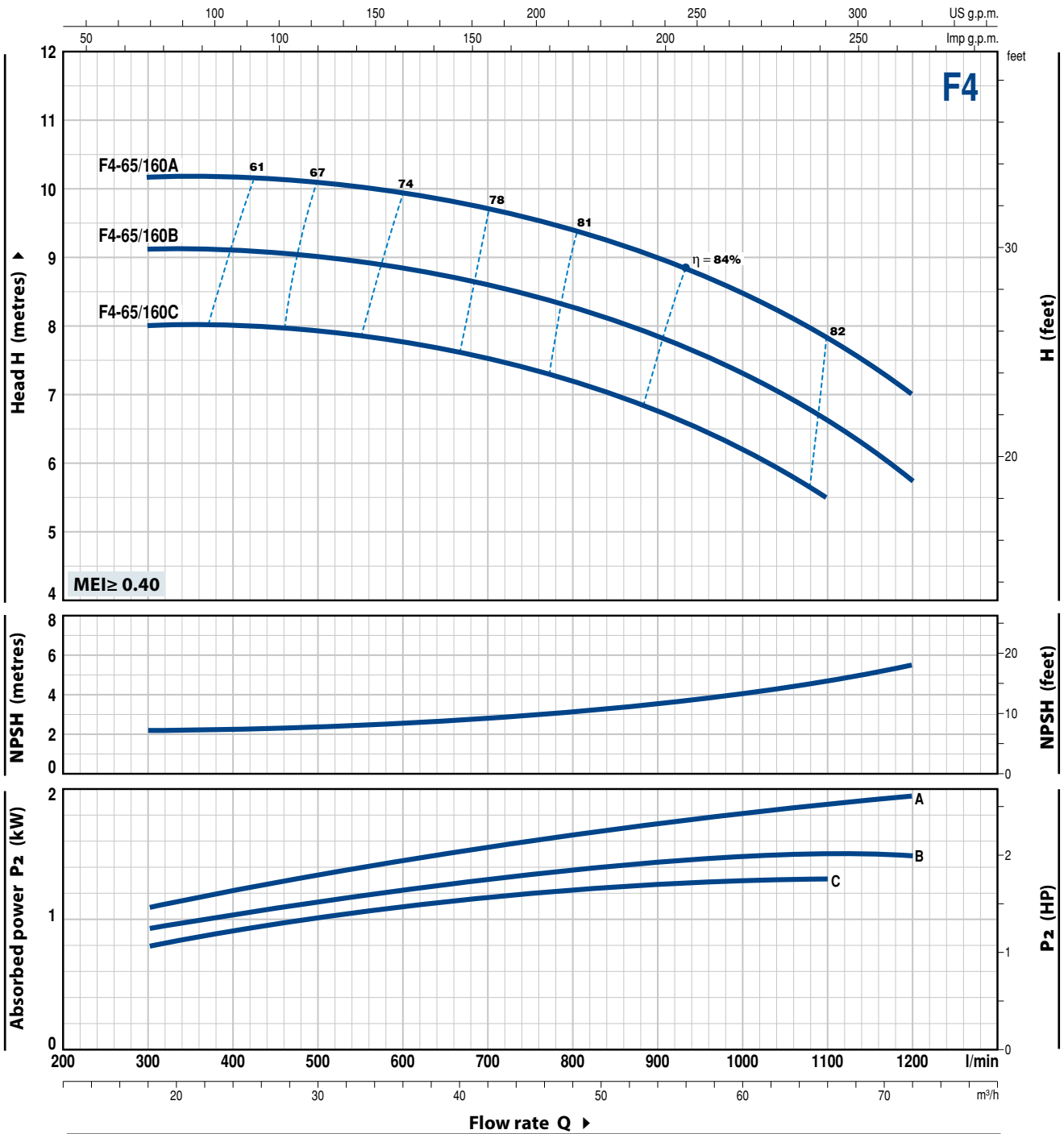

MODEL	POWER (P ₂)		Q	Flow rate											
	kW	HP		m ³ /h	18	24	30	36	42	48	54	60	66	72	
Three-phase			l/min	300	400	500	600	700	800	900	1000	1100	1200		
F4-65/160C	1.1	1.5	H metres	8	8	7.9	7.7	7.5	7.2	6.7	6.2	5.5			
F4-65/160B	1.5	2		9.1	9.1	9	8.8	8.6	8.3	7.8	7.3	6.6	5.7		
F4-65/160A	2.2	3		10.1	10.1	10.1	9.9	9.7	9.4	9	8.5	7.8	7		

Q = Flow rate H = Total manometric head HS = Suction height

Tolerance of characteristic curves in compliance with EN ISO 9906 Grade 3B.

CHARACTERISTIC CURVES AND PERFORMANCE DATA

50 Hz n= 1450 rpm HS= 0 m

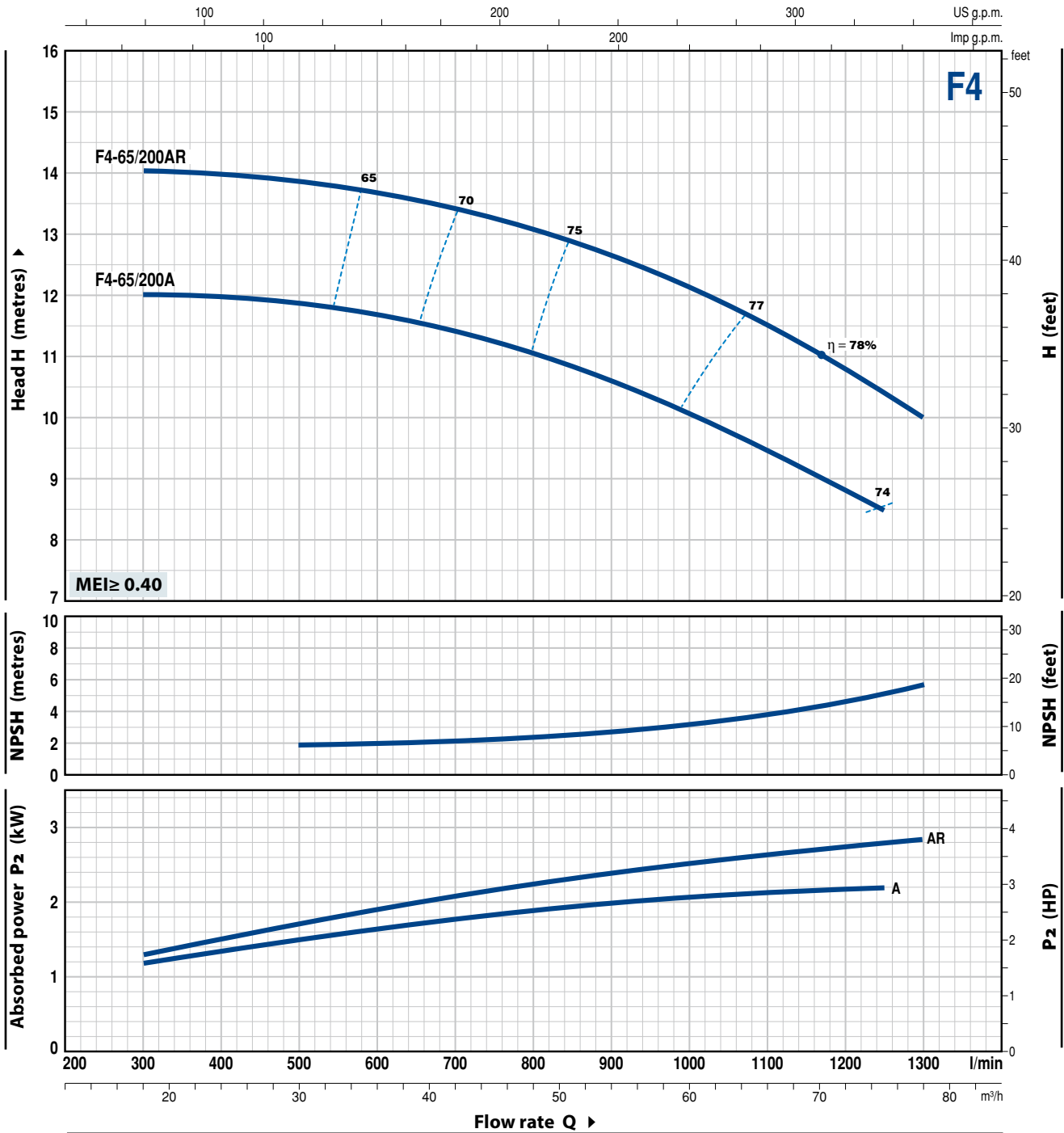

MODEL	POWER (P ₂)		Q	Flow rate														
	kW	HP		m ³ /h	18	24	30	36	42	48	54	60	66	72	75	78		
Three-phase				300	400	500	600	700	800	900	1000	1100	1200	1250	1300			
F4-65/200A	2.2	3	H metres	12	12	11.9	11.6	11.4	11	10.6	10.1	9.5	8.8	8.5				
F4-65/200AR	3	4	H metres	14	13.9	13.8	13.6	13.4	13.1	12.7	12.1	11.5	10.8	10.3	10			

Q = Flow rate H = Total manometric head HS = Suction height

Tolerance of characteristic curves in compliance with EN ISO 9906 Grade 3B.

F4-65/250

CHARACTERISTIC CURVES AND PERFORMANCE DATA

50 Hz n= 1450 rpm HS= 0 m

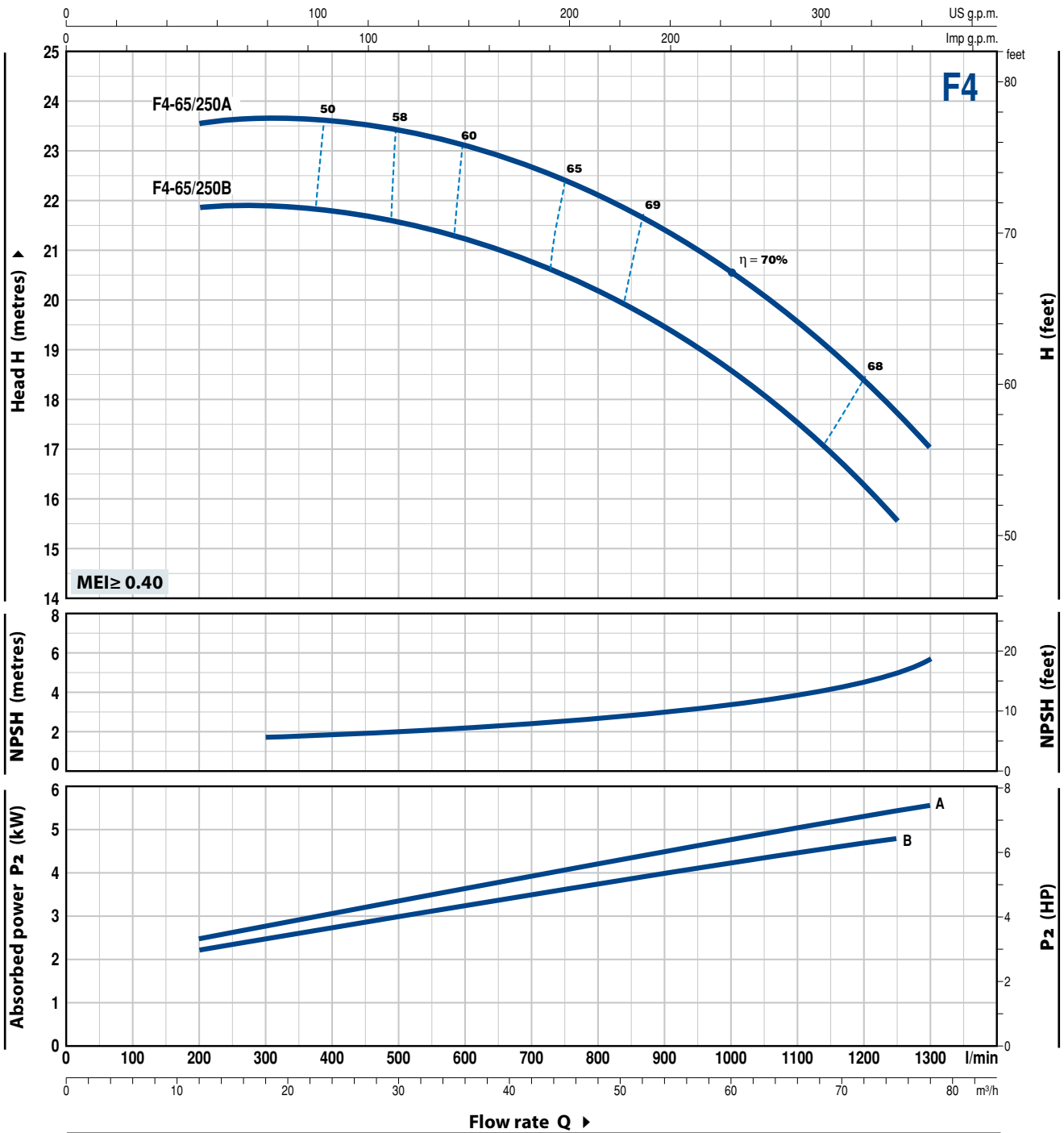

MODEL	POWER (P ₂)		Q	12	18	24	30	36	42	48	54	60	66	72	75	78
	kW	HP		l/min	200	300	400	500	600	700	800	900	1000	1100	1200	1250
F4-65/250B	4	5.5	H metres	21.8	21.8	21.7	21.5	21.2	20.7	20.2	19.5	18.6	17.5	16.2	15.5	
F4-65/250A	5.5	7.5		23.5	23.5	23.5	23.4	23.1	22.6	22.1	21.5	20.5	19.6	18.5	17.8	17

Q = Flow rate H = Total manometric head HS = Suction height

Tolerance of characteristic curves in compliance with EN ISO 9906 Grade 3B.

CHARACTERISTIC CURVES AND PERFORMANCE DATA

50 Hz n= 1450 rpm HS= 0 m

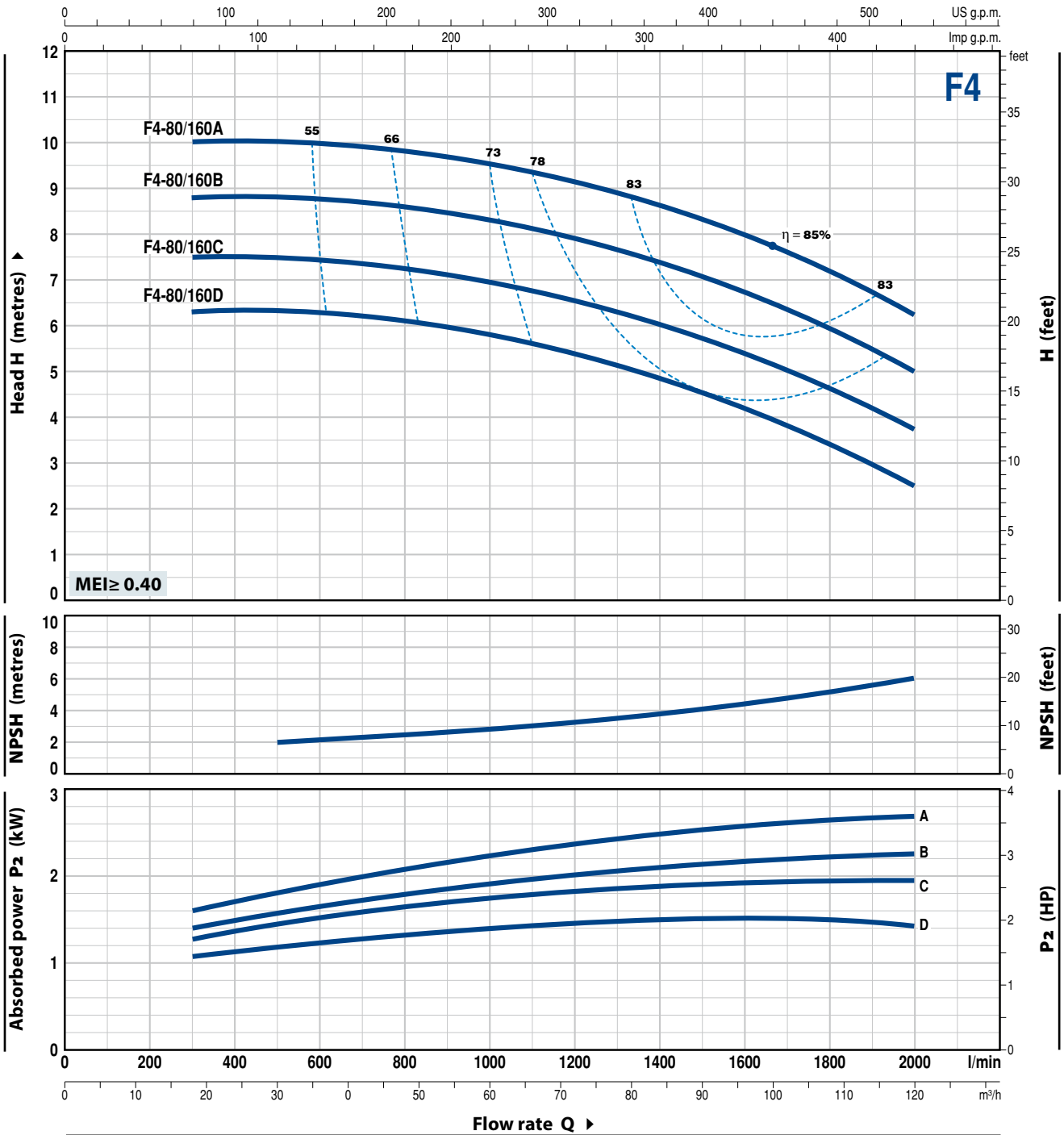

MODEL	POWER (P ₂)		Q	Flow rate											
	kW	HP		m ³ /h	18	24	36	48	60	72	84	96	108	120	
Three-phase			l/min	300	400	600	800	1000	1200	1400	1600	1800	2000		
F4-80/160D	1.5	2	H metres	6.3	6.3	6.3	6.1	5.8	5.4	4.8	4.2	3.4	2.5		
F4-80/160C	2.2	3		7.5	7.5	7.4	7.3	6.9	6.5	6	5.4	4.6	3.8		
F4-80/160B	2.2	3		8.8	8.8	8.8	8.6	8.3	7.9	7.4	6.7	5.9	5		
F4-80/160A	3	4		10	10	10	9.8	9.5	9.1	8.6	8	7.2	6.2		

Q = Flow rate H = Total manometric head HS = Suction height

Tolerance of characteristic curves in compliance with EN ISO 9906 Grade 3B.

F4-80/200

CHARACTERISTIC CURVES AND PERFORMANCE DATA

50 Hz n= 1450 rpm HS= 0 m

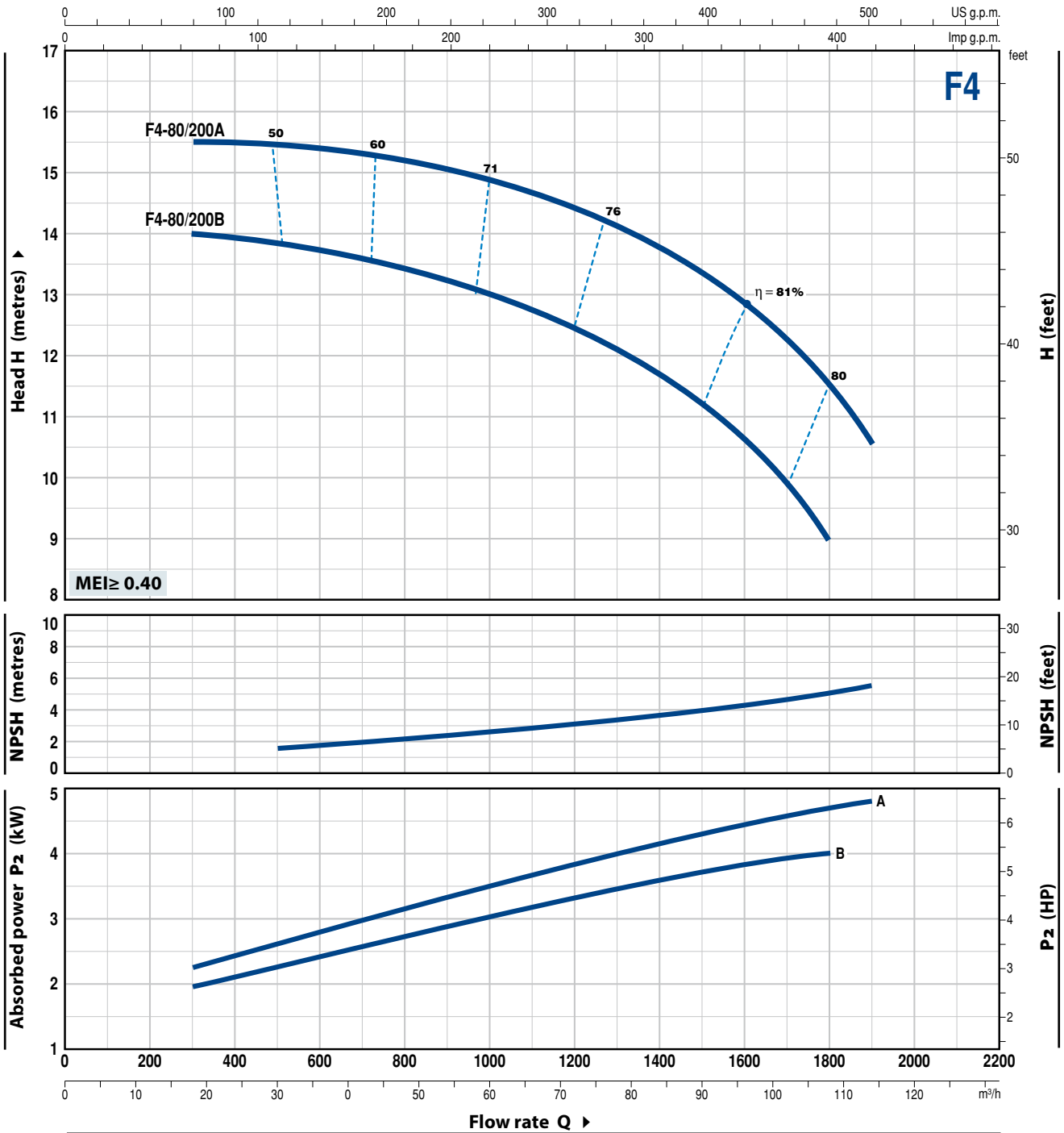

MODEL	POWER (P ₂)		Q	Flow rate											
	kW	HP		m ³ /h	18	24	36	48	60	72	84	96	108	114	
Three-phase			l/min	300	400	600	800	1000	1200	1400	1600	1800	1900		
F4-80/200B	4	5.5	H metres	14	13.9	13.7	13.4	13	12.5	11.7	10.6	9			
F4-80/200A	5.5	7.5		15.5	15.5	15.4	15.2	14.8	14.5	13.7	12.8	11.5	10.5		

Q = Flow rate H = Total manometric head HS = Suction height

Tolerance of characteristic curves in compliance with EN ISO 9906 Grade 3B.

CHARACTERISTIC CURVES AND PERFORMANCE DATA

50 Hz n= 1450 rpm HS= 0 m

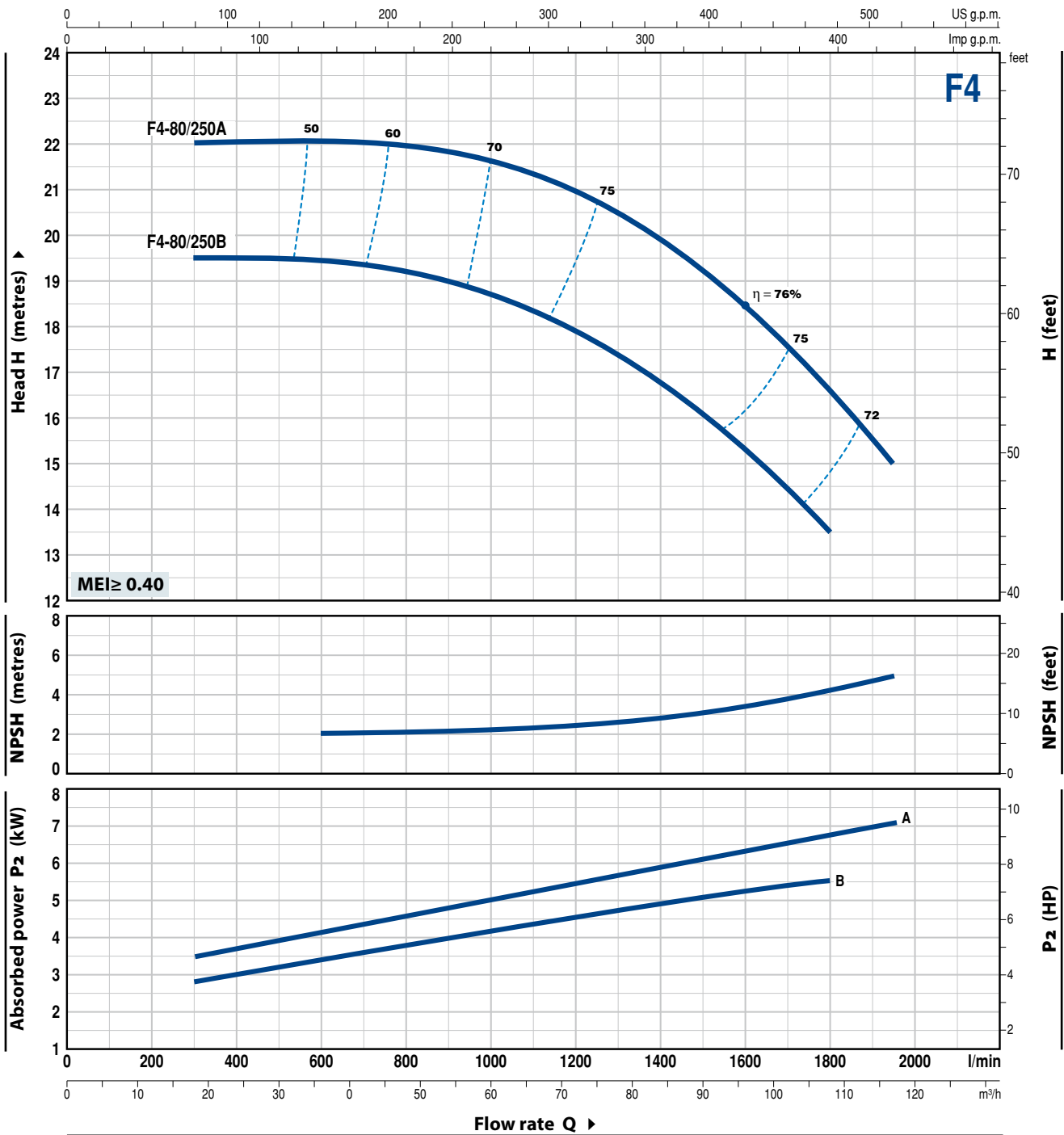

MODEL	POWER (P ₂)		Q	Flow rate												
	kW	HP		m ³ /h	18	24	36	48	60	72	84	96	108	117		
Three-phase			l/min	300	400	600	800	1000	1200	1400	1600	1800	1950			
F4-80/250B	5.5	7.5	H metres	19.5	19.5	19.5	19.2	18.7	17.9	16.7	15.3	13.5				
F4-80/250A	7.5	10		22	22	22	21.9	21.6	21	20	18.5	16.5	15			

Q = Flow rate H = Total manometric head HS = Suction height

Tolerance of characteristic curves in compliance with EN ISO 9906 Grade 3B.

F4-100/160

CHARACTERISTIC CURVES AND PERFORMANCE DATA

50 Hz n= 1450 rpm HS= 0 m

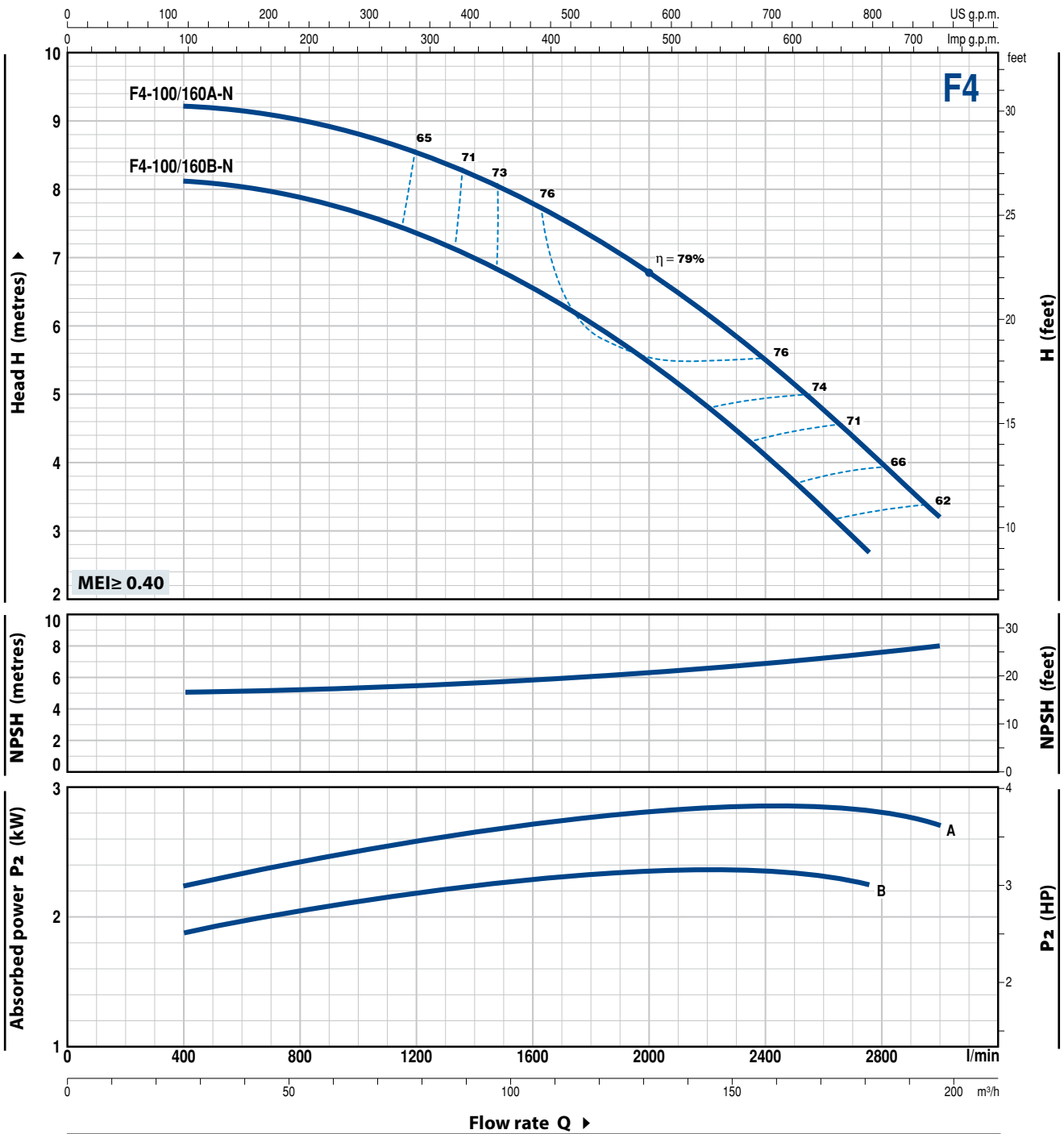

MODEL	POWER (P ₂)		Q	Flow rate									
	kW	HP		m ³ /h	24	48	72	96	120	144	165	180	
Three-phase			l/min	400	800	1200	1600	2000	2400	2750	3000		
F4-100/160B-N	2.2	3	H metres	8.1	7.9	7.3	6.5	5.5	4.1	2.7			
F4-100/160A-N	3	4		9.2	9	8.5	7.8	6.8	5.5	4.2	3.2		

Q = Flow rate H = Total manometric head HS = Suction height

Tolerance of characteristic curves in compliance with EN ISO 9906 Grade 3B.

CHARACTERISTIC CURVES AND PERFORMANCE DATA

50 Hz n= 1450 rpm HS= 0 m

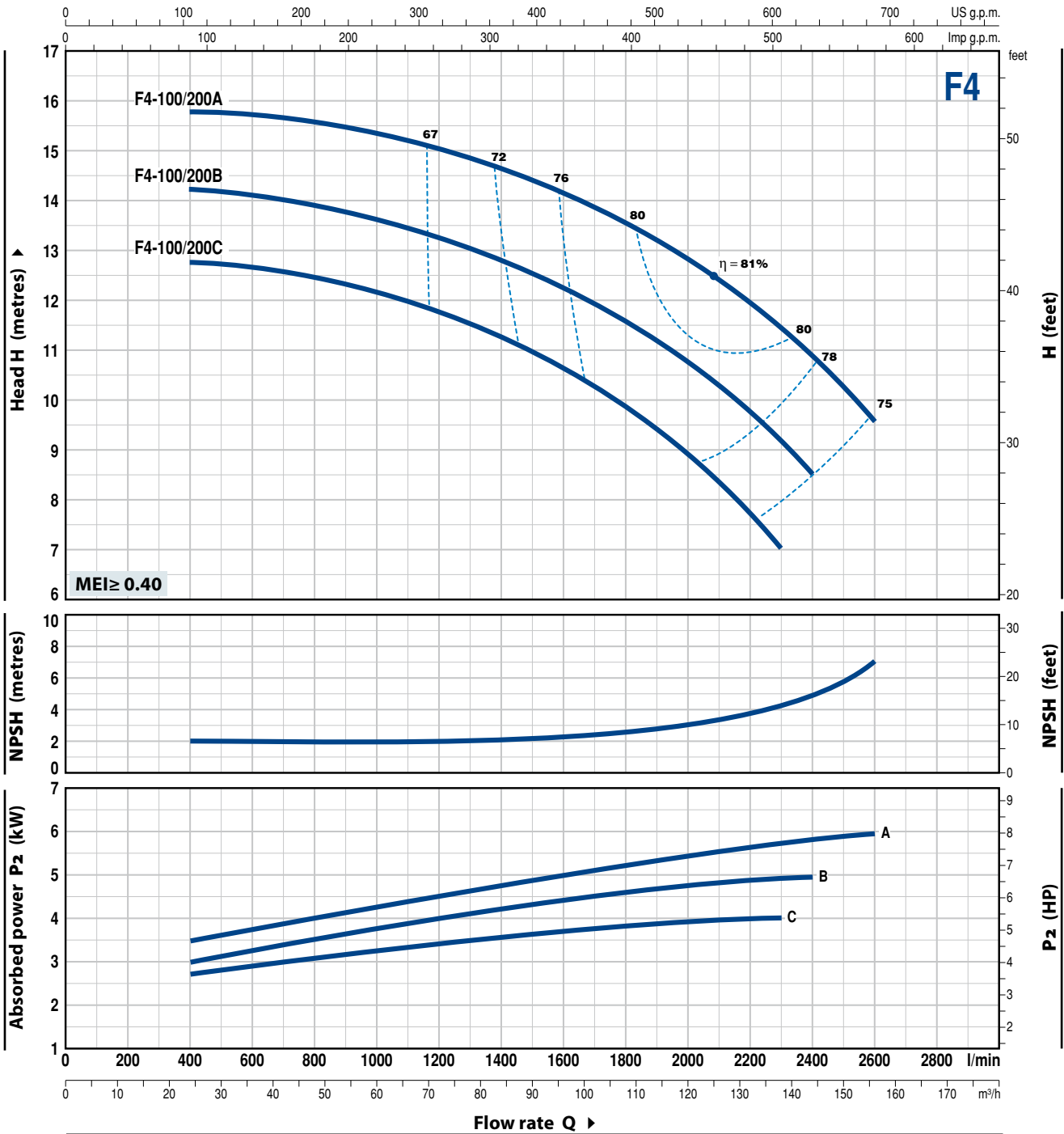

MODEL	POWER (P ₂)		Q	Flow rate														
	kW	HP		m ³ /h	24	36	48	60	72	84	96	108	120	138	144	156		
Three-phase			l/min	400	600	800	1000	1200	1400	1600	1800	2000	2300	2400	2600			
F4-100/200C	4	5.5	H metres	12.7	12.6	12.5	12.2	11.8	11.3	10.6	9.9	8.9	7					
F4-100/200B	5.5	7.5		14.2	14.1	13.9	13.6	13.3	12.8	12.2	11.6	10.7	9.2	8.5				
F4-100/200A	5.5	7.5		15.8	15.7	15.6	15.4	15	14.6	14.2	13.5	12.8	12	11.4	9.5			

Q = Flow rate H = Total manometric head HS = Suction height

Tolerance of characteristic curves in compliance with EN ISO 9906 Grade 3B.

F4-100/250

CHARACTERISTIC CURVES AND PERFORMANCE DATA

50 Hz n= 1450 rpm HS= 0 m

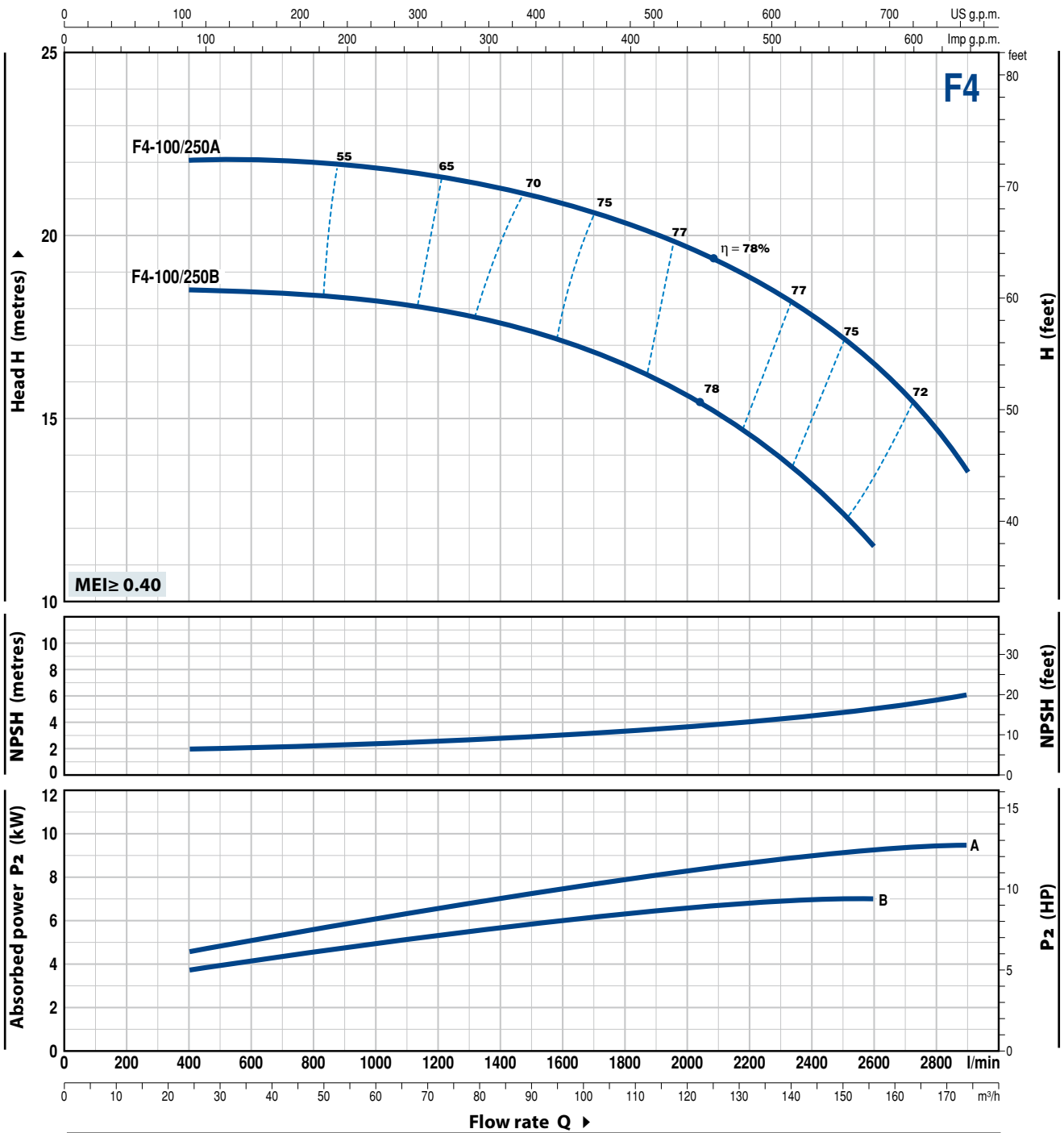

MODEL	POWER (P ₂)		Q	24	36	48	60	72	84	96	108	120	132	144	156	174
	kW	HP		l/min	400	600	800	1000	1200	1400	1600	1800	2000	2200	2400	2600
F4-100/250B	7.5	10	H metres	18.5	18.5	18.3	18.2	18	17.5	17.1	16.5	15.7	14.5	13.2	11.5	
F4-100/250A	9.2	12.5	H metres	22	22	22	21.8	21.6	21.2	20.9	20.3	19.7	18.9	17.9	16.5	13.5

Q = Flow rate H = Total manometric head HS = Suction height

Tolerance of characteristic curves in compliance with EN ISO 9906 Grade 3B.

POS. COMPONENT CONSTRUCTION CHARACTERISTICS

1 PUMP BODY	Cast iron, complete with flanged suction and delivery ports					
2 BODY BACKPLATE	Cast iron					
3 IMPELLER	Brass for F4-32/160, 32/200, 40/160, 40/200, 50/125, 50/160					
4 MOTOR SHAFT	Stainless steel EN 10088-3 - 1.4104					
5 MECHANICAL SEAL	Pump Model	Seal Model	Shaft Diameter	Stationary ring	Rotational ring	Elastomer
	F4-32/160 F4-40/160	F4-50/125	FN-20	Ø 20 mm	Graphite	Ceramic NBR
	F4-32/200 F4-40/200	F4-50/160 F4-65/125	FN-24	Ø 24 mm	Graphite	Ceramic NBR
	F4-50/200 F4-65/200 F4-65/160	F4-80/160 F4-100/160	FN-32 NU	Ø 32 mm	Graphite	Ceramic NBR
	F4-32/250 F4-40/250	F4-50/250	FN-38	Ø 38 mm	Graphite	Ceramic NBR
	F4-65/250 F4-80/200	F4-100/200	FN-40 NU	Ø 40 mm	Graphite	Ceramic NBR
	F4-80/250	F4-100/250	FH-45 NU	Ø 45 mm	Graphite	Ceramic NBR
6 BEARINGS	Pump Model	Pump Model	Pump Model	Pump Model	Pump Model	Pump Model
	F4-32/160 F4-40/160 F4-50/125	6206 ZZ-C3 / 6204 ZZ	F4-32/250 F4-40/250 F4-50/200 F4-50/250 F4-65/160 F4-65/200 F4-80/160 F4-100/160	6208 ZZ-C3 / 6206 ZZ-C3		
	F4-32/200 F4-40/200 F4-50/160 F4-65/125	6307 ZZ-C3 / 6206 ZZ-C3	F4-65/250 F4-80/200 F4-80/250 F4-100/200 F4-100/250	6310 ZZ-C3 / 6308 ZZ-C3		
7 ELECTRIC MOTOR	F4: with 4 poles three-phase 230/400 V - 50 Hz ➔ The three-phase pumps are fitted with high performance motors up to P2=1.1 kW in class IE2 and from P2=1.5 kW in class IE3 (IEC 60034-30) – Insulation: class F – Protection: IP X5					

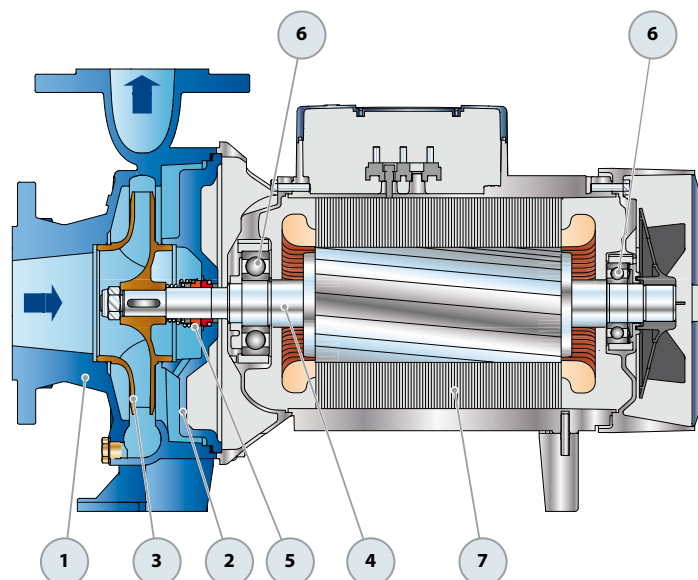

DIMENSIONS AND WEIGHT

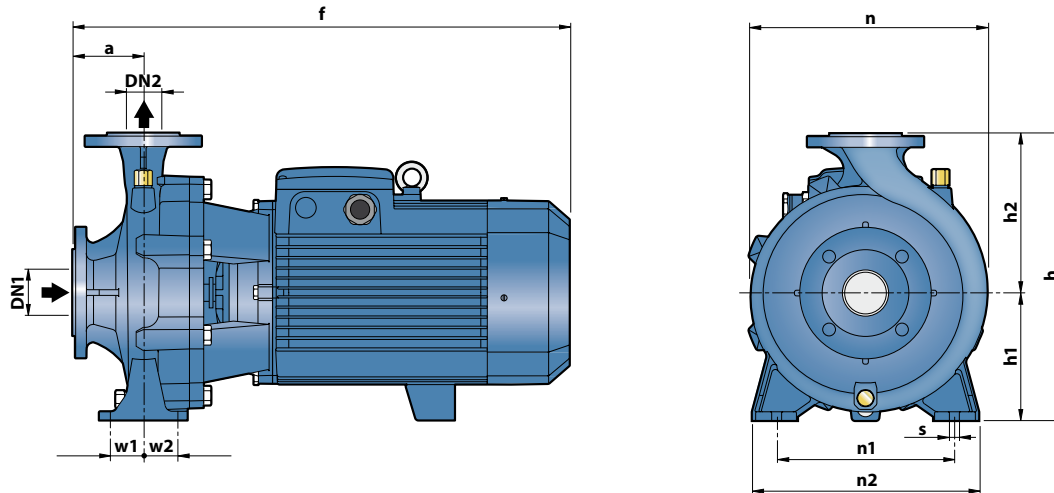

MODEL	DIMENSIONS mm													kg	
	DN1	DN2	a	f	h	h1	h2	n	n1	n2	w1	w2	s		
Three-phase															
F4-32/160B	50	32	80	412	292	132	160	242	190	240	35	35	14	31.2	
F4-32/160A				31.3											
F4-32/200B				43.4											
F4-32/200A				43.5											
F4-32/200BH			42.3												
F4-32/200AH			42.4												
F4-32/250C			100	522	405	180	225	330	250	320	405	47.5		59.7	
F4-32/250B				63.1											
F4-32/250A	568	68.7													
F4-40/160B	65	40	80	412	292	132	160	240	190	240	35	35	14	32.5	
F4-40/160A				32.9											
F4-40/200B			100	489	340	160	180	275	212	265	46.0				
F4-40/200A				46.1											
F4-40/250C				522	405	180	225	328	250	320	47.5	47.5		59.7	
F4-40/250B				63.1											
F4-40/250A	568	68.7													
F4-50/125B	65	50	100	431	292	132	160	242	190	240	35	35	14	32.2	
F4-50/125A				32.3											
F4-50/160B				489	340	160	180	269	212	265				44.4	
F4-50/160A					44.5										
F4-50/200C				529	360	200	316	212	265	59.2					
F4-50/200B				64.4											
F4-50/200A			576	64.7											
F4-50/200AR			68.8												
F4-50/250D			522	59.9											
F4-50/250C				63.3											
F4-50/250B				68.7											
F4-50/250A				69.1											
F4-50/250AR	73.2														
F4-65/125B	80	65		100	511	340	160	180	291	212	280	47.5	47.5	14	51.0
F4-65/125A			51.1												
F4-65/160C			533		360	200	300	63.7							
F4-65/160B			57.7												
F4-65/160A			579		63.7										
F4-65/200A			58.2		405	180	225	340	250	320	69.0				
F4-65/200AR			73.0												
F4-65/250B			62.7		450	200	250	373	280	360	60	60	18		123.8
F4-65/250A			72.2		139.6										
F4-80/160D			100		80	125	565	405	180	225	330	250	320		47.5
F4-80/160C	67.3														
F4-80/160B	611	67.5													
F4-80/160A	71.4														
F4-80/200B	655	430		250		360	280	345	114.4						
F4-80/200A	750	130.2													
F4-80/250B	768	480		200		280	405	315	400	60	60	18	149.5		
F4-80/250A	166.0														
F4-100/160B-N	125	100	125	622	480	200	280	362	280	360	60	60	18	70.7	
F4-100/160A-N				78.1											
F4-100/200C				657				124.1							
F4-100/200B			752	139.8											
F4-100/200A			789	140.1											
F4-100/250B			821	505	225	422	315	400	173.5						
F4-100/250A	182.9														

FLANGED PORTS

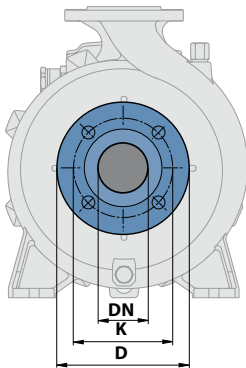

DN FLANGES mm	D mm	K mm	HOLES	
			N.	Ø (mm)
32	140	100	4	18
40	150	110		
50	165	125		
65	185	145		
80	200	160	8	
100	220	180		
125	250	210		

COUNTER FLANGES

(CAN BE ORDERED SEPARATELY)

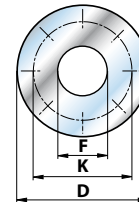

DN FLANGES mm	F COUNTER FLANGES	D mm	K mm	HOLES	
				N.	Ø (mm)
32	1¼"	140	100	4	18
40	1½"	150	110		
50	2"	165	125		
65	2½"	185	145		
80	3"	200	160	8	
100	4"	220	180		
125	5"	250	210		

ABSORPTION

MODEL	VOLTAGE	
	230÷240 V	400÷415 V
Three-phase		
F4-32/160B	1.9 A	1.1 A
F4-32/160A	2.3 A	1.3 A
F4-32/200B	3.6 A	2.1 A
F4-32/200A	4.0 A	2.3 A
F4-32/200BH	3.1 A	1.8 A
F4-32/200AH	3.5 A	2.0 A
F4-32/250C	4.5 A	2.6 A
F4-32/250B	5.7 A	3.3 A
F4-32/250A	9.0 A	5.2 A
F4-40/160B	2.1 A	1.2 A
F4-40/160A	2.8 A	1.6 A
F4-40/200B	3.6 A	2.1 A
F4-40/200A	4.2 A	2.4 A
F4-40/250C	4.5 A	2.6 A
F4-40/250B	6.1 A	3.5 A
F4-40/250A	9.0 A	5.2 A
F4-50/125B	2.4 A	1.4 A
F4-50/125A	2.6 A	1.5 A
F4-50/160B	3.6 A	2.1 A
F4-50/160A	4.2 A	2.4 A
F4-50/200C	6.1 A	3.5 A
F4-50/200B	8.0 A	4.6 A
F4-50/200A	9.0 A	5.2 A
F4-50/200AR	11.8 A	6.8 A
F4-50/250D	4.5 A	2.6 A
F4-50/250C	5.9 A	3.4 A
F4-50/250B	8.5 A	4.9 A
F4-50/250A	9.9 A	5.7 A
F4-50/250AR	11.8 A	6.8 A

MODEL	VOLTAGE	
	230÷240 V	400÷415 V
Three-phase		
F4-65/125B	3.6 A	2.1 A
F4-65/125A	4.5 A	2.6 A
F4-65/160C	4.7 A	2.7 A
F4-65/160B	5.9 A	3.4 A
F4-65/160A	7.8 A	4.5 A
F4-65/200A	9.0 A	5.2 A
F4-65/200AR	11.8 A	6.8 A
F4-65/250B	16.4 A	9.5 A
F4-65/250A	23.4 A	13.5 A
F4-80/160D	5.9 A	3.4 A
F4-80/160C	8.1 A	4.7 A
F4-80/160B	9.2 A	5.3 A
F4-80/160A	11.8 A	6.8 A
F4-80/200B	16.4 A	9.5 A
F4-80/200A	22.2 A	12.8 A
F4-80/250B	23.4 A	13.5 A
F4-80/250A	25.6 A	14.8 A
F4-100/160B-N	9.0 A	5.2 A
F4-100/160A-N	11.8 A	6.8 A
F4-100/200C	16.4 A	9.5 A
F4-100/200B	21.0 A	12.1 A
F4-100/200A	23.4 A	13.5 A
F4-100/250B	27.5 A	15.9 A
F4-100/250A	34.1 A	19.7 A